

2019

An Introduction to Logic: From Everyday Life to Formal Systems

Albert Mosley

Smith College, amosley@smith.edu

Eulalio Baltazar

Follow this and additional works at: <https://scholarworks.smith.edu/textbooks>

 Part of the [Logic and Foundations of Mathematics Commons](#)

Recommended Citation

Mosley, Albert and Baltazar, Eulalio, "An Introduction to Logic: From Everyday Life to Formal Systems" (2019). Open Educational Resources: Textbooks, Smith College, Northampton, MA.
<https://scholarworks.smith.edu/textbooks/1>

This Book has been accepted for inclusion in Open Educational Resources: Textbooks by an authorized administrator of Smith ScholarWorks. For more information, please contact scholarworks@smith.edu

**AN INTRODUCTION TO
LOGIC**

FROM EVERYDAY LIFE
TO FORMAL SYSTEMS

Dr. Albert Mosley
Dr. Eulalio Baltazar

2019
Northampton, Massachusetts

AN INTRODUCTION TO LOGIC
FROM EVERYDAY LIFE TO FORMAL SYSTEMS

Dr. Albert Mosley

Dr. Eulalio Baltazar

© Copyright 2019 Dr. Albert Mosley

This work is licensed under a Creative Commons Attribution-NonCommercial-ShareAlike 4.0 International License. For more information, visit <https://creativecommons.org/licenses/by-nc-sa/4.0/>

TABLE OF CONTENTS

INTRODUCTION: LANGUAGE AND RATIONALITY	i-v
--	-----

CHAPTER 1: THE STRUCTURE OF ARGUMENTS

A. Distinguishing Arguments from Non-arguments	1
B. Logic in Everyday Life	13
C. Classical Logic: Categorical	17
D. Refutations	23
E. Validity and Soundness	29
F. Modern Logic: Truth-Functional	32
G. Refutations	38
H. Validity and Soundness	44

CHAPTER 2: CLASSICAL LOGIC

A. Categorical Propositions	47
B. Definitions	53
C. Definition by Genus and Difference	63
D. Translation From Ordinary Language to Formal Logic	67

CHAPTER 3: CATEGORICAL INFERENCE

A. Arguments Expressing Immediate Inference	79
B. Set Theoretic Concepts: Complementation, Venn Diagrams, and Distribution	109
C. Obversion	117
D. Conversion	128
E. Contraposition	135
F. Categorical Syllogisms	138
G. Validity, Truth, and Soundness	150
H. Existential Import	179
I. Enthymemes: How to Supply Unexpressed Premises and Conclusions	184

CHAPTER 4: MODERN LOGIC

A. Truth Functional Propositions	185
Atomic Propositions _____	186
Compound Propositions _____	191
Translation _____	195
B. Symbolic Notation for Truth-Functional Propositions	200
Logic Diagrams _____	205
C. Truth-Functional Arguments _____	211
Disjunctive Syllogisms _____	213
Conditional Syllogism	223
D. Truth Tables _____	237
Propositions _____	237
Arguments _____	257
E. Propositions with Quantifiers _____	266
Propositions with Mixed Quantifiers _____	268

CHAPTER 5: APPLICATIONS OF MODERN LOGIC*

A. Logic and Computers _____	271
Circuit Diagrams _____	272
Disjunctive Normal Forms _____	275
Computer Gates _____	278
C. Logic and Probability _____	284
Mathematical Probabilities _____	285
Relative Frequencies _____	290
Compound Probabilities: Negation, Conjunction, Disjunction _____	294
Risk _____	302

CHAPTER 6: INDUCTIVE INFERENCES

A. Inductive Generalizations _____	308
Inductive Instantiations _____	312
Stereotypes _____	314
B. Analogical Inferences _____	316
Primary and Secondary Analogues _____	316
Weak and Strong Analogies _____	320
C. Causal Inferences _____	322
Necessary and Sufficient Conditions _____	322
Mill's Methods _____	323
Inferences in Science & Medicine _____	328
Causal Fallacies _____	330
Stereotype Threat _____	332

CHAPTER 7: INFORMAL FALLACIES

A. Fallacies With Invalid Argument Forms _____	334
B. Category Fallacies _____	341
C. Fallacies With Valid Argument Forms _____	344
D. Miscellaneous Fallacies _____	357

Appendix: Logic and Natural Deduction

Inferences in Propositional Calculus _____	361
Inferences in Predicate Calculus _____	374

Introduction: Language and Rationality

A. Different Ways to Use Language

When we use words to communicate, we are not always trying to say something that is either true or false. When a person, for instance, says, "Please pass me that paper," he or she has not said anything that is true or false. Rather, that person has made a request that will either be granted or not granted. Likewise, when a mother tells her child, "Always hold an adults' hand when you go across the street," she has not said anything that is true or false. Rather, she has issued a command. If someone asks, "Sir, where is the White House located?," that individual has not made an assertion about any state of affairs, but has asked a question. There are many uses that language can be put to: making requests, issuing commands, asking questions, and expressing emotion. Making assertions that are either true or false is only one of them. It is that particular usage that we are most concerned with in logic.

A proposition is a description of some state of affairs that is either true or false. One way of determining whether a proposition is true is to actually observe the state of affairs it describes and see if that state of affairs corresponds to the description given. For instance, if someone declares that it is raining outside, one way of determining if this is actually true is to look outside and see if rain is falling. If rain is falling, then the proposition, "It is raining outside" is true. If rain is not falling, then the proposition is false.

However, we do not always use direct observation in order to decide whether a proposition is true or false. Often, we *infer* the truth or falsity of a proposition. Although we might not be able to see or hear what is going on outside, if someone enters from outside wearing a wet raincoat and is carrying a wet umbrella, we would normally conclude that the proposition, "It is raining outside" is true. Logic is concerned with how we reason from certain propositions accepted as true (e.g., Jones has just entered from outside wearing a wet raincoat and carrying a wet umbrella) to different propositions not otherwise known to be true (e.g., It is raining outside.) In everyday life and in formal systems, logic is the study of the forms of correct inference.

Although we might infer the truth of the proposition, "It is raining outside", from the wet raincoat and wet umbrella, normally we could still establish its truth or falsity independently by simply walking outside. But this kind of direct observation is not always possible. Suppose, for instance, that the safe in Jones' house has been robbed and we suspect Brown. Since the robbery has already taken place, it is not possible to directly observe who committed the robbery. The actual commission of the robbery is a historical fact no longer available to direct observation. This, however, does not mean that it is impossible to determine the truth as to whether Brown committed the robbery. It merely means that establishing who committed the robbery by direct observation is impossible. But by using logic, it is possible to *infer* whether or not Brown committed the robbery.

Suppose the police are called and they find fresh fingerprints on the safe. If those fingerprints match fingerprints previously taken from Brown's hands, then, it is reasonable for them to conclude that Brown robbed the safe. In court, the prosecutor could argue from the fact that Brown's fingerprints were on the safe (and other facts, e.g., that Brown had no witnesses to establish where he was at the time of the robbery, and that Brown had a history of robberies) to the conclusion that Brown robbed the safe in Jones' house. Brown's defense attorney, on the other hand, could present arguments to show that Brown's fingerprints on the safe were not sufficient evidence to conclude that Brown had robbed the safe. For example, what if Brown may have accidentally touched the safe while cleaning around it? What if Brown, with Jones' permission, had recently looked inside the safe at a rare coin?

It is only because human beings are able to make logical inferences that we are able to know so many things to be true without direct experience of what is described. History and science would be impossible without logic. No human being has traveled from the earth to the sun. Yet, we know that the distance from the earth to the sun is approximately 93,000,000 miles. No thermometer has ever been placed at the interior of the earth. Yet, we know that the temperature of the earth's core is approximately 4,000 degrees centigrade. Such facts are known, not from direct experience of the situations described, but by inference from other facts already accepted as true.

We depend on inferences not only in academic disciplines such as history and science, but in our everyday personal interactions with one another. We make inferences whenever we form an opinion about a person's intentions based on his or her actions. We do not directly observe other peoples intentions. Rather, a person's intentions are inferred from what we do observe. A common source of misunderstanding is the failure to appreciate that, while we may observe what a person does, we do not observe the person's intentions.

B. Rationality

Every situation is open to multiple interpretations depending on the perspective from which it is viewed. In order to know what a person's intentions are, it is necessary to see that person's actions from that person's point of view. When we ask a person why he or she is doing something, we are asking that person to express in words the assumptions which give meaning to what that person is doing. We are, in short, asking for an explanation of his or her actions.

Being rational means accepting the responsibility of putting actions and situations into a framework that others can use to understand those actions and situations. Since different people may interpret the same action or situation in different ways, each must attempt to communicate to the other the different assumptions he or she brings to bear on the case at hand. One is rational to the extent that one is committed to maintaining and strengthening one's relationship with others through the exchange of information and different points of view.

When a person communicates to others the framework within which he or she is acting, then others are able to understand what that person is doing. This also forms a basis for understanding some of the things the person has done in the past and will do in the future. A rational framework gives meaning to a particular thing, situation, or activity by clearly indicating its relationship to other things, situations, and activities. By establishing such relationships, a rational framework makes possible inferences from present situations to past and future situations, and from a particular case to other similar cases.

Consider the following:

If you see Tamara walk to a window, open it, and climb out onto the ledge, in order to know what Tamara intends requires that you engage in inquiry. You might ask her why she is climbing onto the window ledge. Your question might elicit one of the following responses: (1) the dirty window panes irritate her, and she is climbing onto the ledge in order to clean them; (2) the building is on fire and all exits are blocked except the windows; or (3) she has grown tired of the loneliness and futility of life and has decided to commit suicide.

Given the first explanation of why Tamara is climbing onto the window ledge, others may expect her to clean the window and then climb back inside. Based on the second and third explanations, however, she would be expected to leap from the ledge, instead of climbing back inside. But even though we might expect her to leap in the second and third cases, the reasons why she is expected to leap are different. Though she may leap in either case, the meaning of her leaping, or what she intends to accomplish by leaping, is different. In the second case, by leaping she means to save her life, while in the third case, by leaping she means to end her life.

An essential part of being rational is recognizing that when we see someone do something, it is not always possible to see what that person intends by what he or she is doing. One common source of misunderstanding often occurs when two people assume that they understand what one another means, when, in fact, they don't understand. As a result, people often argue in disagreement when, in fact, they agree. In other cases, people believe they are in agreement when, in fact, they are not. By requiring that the assumptions underlying our judgments and actions be spelled out as clearly and precisely as possible, logic facilitates the sharing and exchange of different points of view. We learn to avoid assuming that we know what another person means or intends without having to explain how we know. When we characterize what someone does or says, we should be prepared to explain why we believe that particular interpretation is true.

What has been said about understanding what another person is doing applies equally to understanding our own actions. We understand our own actions to the degree that we have articulated to ourselves a framework that gives meaning to those actions. But even this is not sufficient for one who is committed to being rational. A person may believe that she understands what she is doing, but the ultimate test of this is whether she is able to communicate this understanding to others. For, if no one can understand what she means, it is not obvious that she is making sense at all. Clarifying our actions and thoughts to others is an essential part of clarifying our actions and thoughts to ourselves.

CHAPTER 1: THE STRUCTURE OF ARGUMENTS

1.A. Distinguishing Arguments from Non-arguments

Not any collection of propositions is an explanation or argument. Consider the following passage:

Wilson walked down the long, dimly-lit corridor. There were doors on each side of the hallway, each about five feet apart. As he passed he could hear the muffled sound of sleeping children on the other side of the closed doors.

The above passage is certainly a collection of propositions, each of which may be true. But there is no suggestion that the truth of any one of them is meant to follow from the truth of the other two propositions. In order for a collection of propositions to be considered an explanation or argument, the person who asserts those propositions to be true must intend that the truth of a particular one of the propositions (the conclusion) should follow from the truth of the other propositions (the premises).

In an explanation or argument, the collection of propositions is organized with the intention that our acceptance of certain of those propositions as true (the premises) will lead us to accept the truth of another of those propositions whose truth is not otherwise established (the conclusion). Explanations and arguments are similar. In an explanation we attempt to show why a proposition that is not expected to be true is nonetheless true. Thus, we explain why the earth goes around the sun, although it seems that the sun goes around the earth. In an argument we attempt to show why a proposition that may not be considered true should nonetheless be accepted as true. An explanation is often after the fact. An argument is often before the fact. However, unless the speaker intends to establish the truth of some proposition (the conclusion) on the basis of our accepting the truth of certain other propositions (the premises), that speaker is offering neither an explanation nor an argument.

The **standard logical form** for any explanation or argument is to list the premises first and the conclusion last.

premise 1
premise 2
.
.
premise n
conclusion

This is written, laterally, as:

Premise 1 / premise 2 / ... / premise n // conclusion

The premises are supposed to be connected in a way that shows why their truth makes the conclusion true. Often people use words to signal whether a claim they have made is intended to be a premise or a conclusion. These words are called premise-indicators and conclusion-indicators. A word, phrase, or symbol is a premise-indicator if what follows it is the premise of an explanation or argument.

Examples of Premise-Indicators:

Since

Let us assume that

Whereas

Because

Given that

.

.

A word, phrase, or symbol is a conclusion-indicator if what follows it is the conclusion of an argument or explanation.

Examples of Conclusion-Indicators

Therefore

It follows that

So

Hence

Thus

Accordingly

.

.

To illustrate the relationship between premises and conclusions, consider the following episode:

1. Mrs. Jones had had it. She was sick and tired of her son
2. Billy, who failed to pick up after himself, help around the
3. house, or contribute toward paying the bills. She had
4. asked him time and time again to help and he always said
5. he would, but he never really made any attempt to do so.
6. She made up her mind that this was not going to continue.
7. "Billy," she said, as he was about to leave the next morning.
8. "I have something to tell you. When you come back this
9. evening, the locks are going to be changed on the doors.
10. I am not going to let you stay here any longer."
11. Billy was shocked. He knew he neglected his duties, but it
12. had never occurred to him that his mother would ever say
13. such a thing to him.
14. "Why are you going to do that?" he asked.
15. "Because you don't help out and nobody who stays under my
16. roof is going to be a freeloader. So, I'm going to lock

17. you out.”

18. Mrs. Jones looked straight into Billy's eyes as she said
19. this, because she wanted him to know that she meant it.
20. Billy didn't know what to say. He couldn't believe that
21. his mother would actually do what she was threatening.
22. Often, he had found that the best way to deal with her
23. when she was angry was simply to say nothing at all. So,
24. he merely nodded, picked up his coat and walked out the
25. door.

26. When Billy arrived home that night he found his clothes
27. on the sidewalk. He couldn't believe it, and rushed to
28. confront his mother in the house. But when he tried to
29. open the door, his key wouldn't fit the lock.
30. “Mother,” he cried. “How could you do this to me? I
31. thought you loved me, but you don't care anymore about me than
32. you would a stray cat. How could you lock me out like
33. this? How?” he screamed.

34. Mrs. Jones knew he would appeal to her motherly feelings
35. toward him, but she controlled her responses and answered
36. him evenly.

37. “I love you dearly, Billy,” she said, her voice slightly
38. quivering, “but you use my love as a way of avoiding your
39. responsibilities. It is no good for you to get in the
40. habit of using people simply because they care about you,
41. and that is what will happen if I let you keep using me.
42. So, I've decided that it's in your own best interest to
43. learn your lesson now rather than later. You will only
44. hurt yourself by taking advantage of the people who love
45. you. That is why I've put you out.”

46. “You don't really love me,” Billy cried back. “You don't
47. really care, because if you did, you wouldn't put me out

48. with no place to go. What kind of love is that? No,
 49. you don't really care about me. You just want to have
 50. people around who do only what you say do, that's all.”

In lines 7 through 10, Mrs. Jones announces to Billy that she does not intend to allow him to continue residing in her house. In line 14, Billy asks her to explain why she intends to put him out. In lines 15 through 17, Mrs. Jones explains why she intends to put her son out. Her explanation has the following standard form:

No person that is a freeloader is a person who can reside in my house.

You are a freeloader.

You are not a person who can reside in my house.

No person that is a freeloader is a person who can reside in my house. / You are a freeloader. // You are not a person who can reside in my house.

The explanation has the following logical form:

No A is B

A = person that is a freeloader

x is A

B = person who can reside in my home

x is not B

No A is B. / x is A. // x is not B.

In line 37, Mrs. Jones says that she loves Billy, but in line 46-49, Billy attacks that claim, and argues that Mrs. Jones does not really love him. Billy's argument has the following standard form:

If you are a mother that loves her child, then you will not turn that child away with no place to go.

You have turned your child away with no place to go.

You are not a mother that loves her child.

If you are a mother that loves her child, then you will not turn that child away with no place to go. / You have turned your child away with no place to go. // You are not a mother that lover her child.

Billy's argument has the following logical form, called Modus Tollens:

If P then not Q

Q

Not P

Or: If P then not Q. / Q. // not P

Both Mrs. Jones' explanation and Billy's argument are collections of statements presented with the intention that one proposition, the conclusion, be accepted as true because of its relationship with certain other propositions, the premises, which are assumed to be true. The truth of the conclusion is supposed to follow from the truth of the premises. Thus, we may assume that Mrs. Jones had long held that no freeloader could reside in her house, but it was only when she realized that her son was indeed a freeloader that she was forced to the conclusion that she had to put him out. In a similar fashion, if Billy believes it is true that if a mother loves her child, then she will not turn him away, then his being kicked out will force him to the conclusion that his mother does not love him. Since both explanations and arguments are collections of statements where the truth of the premises are supposed to establish the truth (or falsity) of the conclusion, they have the same basic structure and so, in the remainder of this text, explanations and arguments will be referred to generically as “arguments.”

1.A.1. Exercises on Indicators:

Give other examples of premise-indicators and conclusions-indicators.

1.A.2. Exercises on Distinguishing Arguments from Non-Arguments:

For each of the following, indicate whether it a) is an argument in the generic form by writing “A” or b) is not an argument by writing “NA” on the line provided.

1. I jog every morning because that's the only way I can avoid gaining too much weight.

2. If you have never sampled Chinese cooking, then you cannot say that you prefer American to Chinese cooking. Likewise, if you have never been to Athens, you cannot say that you prefer Paris to Athens. In general, if a person has not sampled all the options available to him, he cannot prefer that which he is familiar with over that which he has no knowledge of.

3. American influence is falling in foreign affairs. Inflation is driving prices sky-high. Pollution is poisoning us with cancer-causing agents, and, global warming is increasing.

4. If I were rich, I'd buy you the highest mountain, but I am not rich. That is why I cannot buy you the highest mountain.

5. I don't know why I should go to college. I don't know why the sun rises every day.

6. Mice are rodents. Rats are rodents. And, hamsters are rodents.

7. The Arabs are the primary oil exporting people in the world today. Most of the Arabian people are in a state of war with Israel. But the United States supports Israel.

8. Since religious freedom requires that the state show no favoritism between religions, it appears that there can be no religious freedom in America, for the American constitution was created in accordance with Christian principles and these principles are often in conflict with the principles of Islam, Hinduism, and many other religions.

9. The state can order its citizens to face death on the battlefield upon a declaration of war. That is why if a citizen refuses, that citizen is subject to arrest and prosecution.

10. Capitalists are used to exploiting other people. Women are the most exploited of all classes of people. Women make up the majority of churchgoers, too.

1.A.3. Exercises on Distinguishing Premises from Conclusion:

For each of the following arguments, pick out the conclusion and write it on the line below.

1. Since I'd marry you if I loved you, it follows that I cannot marry you, for unfortunately I do not really love you.

2. Either Jones loves music or Jones is trying to trick us. Let us assume that Jones is an honest man and is not trying to trick us. Then, it would appear that Jones really does love music.

3. The coal miners voted to strike because the coal contracts did not meet their demands.

4. Every time I read a book it gives me a headache. So, as far as I'm concerned, I can do without reading because my health is more important to me.

5. All millionaires make interest-free loans to their friends. Accordingly, if I were a millionaire, I'd make interest-free loans to my friends, too.

6. Since this is a red wine, it cannot be a Chablis.

7. Washington, D. C. has become more multi-racial over the last twenty years. Chicago, Detroit, Atlanta, and Philadelphia have too. Thus, the trend is that all large cities are becoming more multi-racial.

8. The Israelis believe they were invaded from Lebanon, and therefore, that they were justified in invading Lebanon.

9. John studies hard and is very conscientious. Hence, John will do well in college because that is what it takes.

10. John doesn't appear to have made it to heaven because he said that if he went to heaven when he died, he'd come back to tell me about it. But, he hasn't been back to say anything to me.

11. Almost every time I eat spinach, I get sick. Thus, if I eat this spinach, then I'll probably get sick.

12. Since no K is R and some R is not T, it follows that some K is not T.

13. Some S are not P because some S are M and some M are not P.

14. Some S are not M and some M are not P. Therefore, some S are not P.

15. Since all A are B, it seems that some A are C because some B are C.

16. No Y is Q and all Q is J, so no Y is J.

17. If I see someone being robbed I would try to help them because I would want someone to try to help me if I were being robbed.

18. Since either you love me or you would not treat me so badly, I surmise that you don't love me, for you do treat me badly.

19. If it is raining outside then there are clouds in the sky, so there must be clouds in the sky because it is certainly raining outside.

20. Some people are taller than others; some are heavier than others; some can run faster than others; and some can swim better than others. Such facts show that it is useless to insist that every person is equal. We are all unequal.

21. Each person is different from each other person and each person has something to offer that another person does not have to offer. Thus, people are equal because people are different.

22. I'm not going to college, for college simply teaches you to survive within the system and the system is decaying.

23. Over the centuries human beings have developed a great deal of knowledge about many different kinds of things. Most of this knowledge has been codified and is taught within our universities. That is why I am going to college.

24. People lose confidence in their ability to adapt to new situations when they stop running, jumping, bending, stooping, crawling, and stretching their bodies into different positions. As a result, people become set in their ways.

25. People stop stretching their bodies into different positions because they become set in their ways and lose confidence in their ability to adapt to new situations.

26. “. . .the intellectual skills normal people display are limited, in practice, not so much by innate restrictions. . .as by the amount of motivating energy they are able to bring to bear on the tasks in question. It is the need to think that fuels the conceptual elaboration; while conversely, the level of skill reached evidences the strength of the need that underlies it. This train of thought leads us to expect that limits in channel capacity are rarely reached; and that many individuals' levels of accomplishment will alter dramatically, for better or worse, as their emotional states alter.”

27. Marx was a materialist only by expedience. His purpose was to show the limits of capitalism. Since no actual socialist societies existed, he could not present an actual alternative to capitalism. But by assuming that material accumulation for self-interest and other assumptions basic to capitalism held, Marx was able to show that capitalism was internally inconsistent and would necessarily destroy itself. Only by hypothetically accepting materialism could Marx prove the transient nature of capitalism. But none of this means that Marx personally was a materialist.

B. Logic in Everyday Life

Logic makes clear the criteria we use for deciding whether a particular conclusion follows from a given set of premises. It is important to recognize that one does not take a course in logic in order to learn how to be logical. People are usually logical. Whether a person is educated or not is irrelevant. Logic is basic to how human beings communicate and interact with one another. To illustrate this, consider the following exchange which takes place between Ms. Flotmos and her three-year-old daughter, Jamie:

1. "If you clean up your room, then I will take you for a treat," said Ms. Flotmos to her daughter, Jamie.
2. Jamie was excited by this and hurriedly cleaned up
3. her room. When she finished, she went to her mother and
4. said, "Well, I'm finished! Can we go for the treat now?"
5. Her mother looked at the room. "You did a wonderful
6. job, Jamie, but why do you speak as if we ought to
7. be going for a treat? You know I am trying hard to lose weight".
8. Jamie was startled. "But, mother," she cried, "you
9. said that if I cleaned up my room, then you would take me
10. for a treat ."
11. "True," Ms. Flotmos replied, "but what does that have
12. to do with me going for a treat?"
13. "But mother," the little girl cried, "you said
14. you would take me for a treat if I cleaned up my room, and
15. I cleaned up my room, so you're supposed to take me for a treat, like you said."
16. But, I didn't merely say that I would take you for an ice cream treat ,
17. Jamie. I said that if you cleaned up your room, then, I
18. would take you for an ice cream treat ," replied
19. Ms. Flotmos. Ms. Flotmos was very concerned about her daughter's
20. intellectual development and always took time to discuss

21. issues with her.
22. “Understand carefully, now Jamie. I really didn't promise
23. that I would take you for a treat,” she said, as she kissed
24. her daughter on the forehead.
25. “But, you did say that if I cleaned up my room, then
26. you would take me for a treat, and that's why I cleaned up
27. my room so fast and so well– so you would take me for a treat. And, now you say that
28. you didn't say you would take
29. me,” Jamie screamed in disbelief at her mother. “Why did
30. you say you would take me if I cleaned up my room and now
31. you won't do what you promised?” Jamie cried.
32. Ms. Flotmos was a bit alarmed by Jamie's tone of voice
33. and wanted to quickly get the situation in hand.
34. “Now , Jamie,” she said firmly, “I've told you before about
35. twisting the truth. I didn't say that I would take you for a treat. What I said was “If
36. you clean your room, then I
37. will take you for a treat .”
38. “That's right,” cried Jamie. “That's what you said,
39. and I did clean my room.”
40. “Well, I'm certainly happy to see that you've cleaned
41. your room, but I really don't like to be misquoted. I
42. didn't just say, ‘I will take you for a treat .’ I said, ‘If you
43. clean your room, then I will take you for a treat .’ Please try to understand: when I say
44. “when”, I say something with an ‘e’ in it, but I am not saying ‘e’. However,
45. since you seem to have your heart set on going for a treat, get
46. your coat and let us go. I love you so that I can't stand to
47. see you so distressed and upset.”
48. Jamie ran and got her coat and away she and her mother
49. went for a treat.

Her mother had said if Jamie cleaned her room, then she (Ms. Flotmos) would take Jamie for a treat, and because Jamie cleaned her room, Jamie felt that her mother was supposed to take her

for a treat. While acknowledging what she had said and acknowledging that Jamie had cleaned up her room, Ms. Flotmos nonetheless felt that she was not obligated to take Jamie for a treat. We intuitively recognize that, though Jamie is only three years old, she is reasoning correctly. Any person who reasons as Ms. Flotmos did would be illogical or a liar or both. Technically, Ms. Flotmos is correct in holding that she did not unconditionally say that she would take Jamie for an ice cream treat. Rather, she made a conditional statement, namely, “If you clean up your room then I will take you for an ice cream treat.” The statement, “I will take you for an ice cream treat,” (where ‘I’ refers to Ms. Flotmos) is a logical inference from the truth of the conditional statement Ms. Flotmos made and the truth of the statement describing what Jamie did.

The statement “I will take you for a treat” is inferred by means of the following argument:

If you (Jamie) clean up your room, then I (Ms. Flotmos) will take you for a treat.

You (Jamie) do clean up your room.

I (Ms. Flotmos) will take you for a treat.

Jamie is justified in drawing the conclusion she did. If her mother spoke the truth when she said, “If you clean up your room then I will take you for a treat,” and it is true that Jamie did clean up her room, then her mother is obligated to act in such a way that the conclusion that she would take her daughter for a treat is made true. If she does not do that, then, either she was not telling the truth when she made the conditional statement or she is illogical.

The conclusion that Ms. Flotmos will take Jamie for a treat follows from the truth of what Ms. Flotmos said and the truth of what Jamie did, just as the conclusion in the following argument follows from the premises given:

If it is raining outside, then there are clouds in the sky.

It is raining outside.

There are clouds in the sky.

Both of these arguments have the same argument form, called Modus Ponens:

If A then B
A
B

In the study of logic, it is important that questions of form be distinguished from questions of content. The truth or falsity of a proposition is independent of the form of that proposition. When Ms. Flotmos said to Jamie, “If you clean up your room, then, I will take you for a treat,” the statement she made had the propositional form, “If A then B,” where:

A = you clean up your room

B = I will take you for a treat.

Whenever one is given a statement of the form “If p then q,” and another statement “p,” and one assumes that both “If p then q” and “p” are true, then one is justified in inferring the truth of the statement referred to by “q.” Any person who does not acknowledge that the truth of “q” follows from the truth of “If p then q” and “p” is illogical. Only if one of the premises is false is one justified in not ascribing truth to such a conclusion.

Logic ignores content and focuses purely on questions of form. We have seen that in representing an argument in standard form, we ignore such particular features as whether the conclusion occurred at the beginning, in the middle, or at the end of the speaker's presentation. In representing the logical form of an argument, we ignore the subject matter of the propositions that make up the argument, and focus on their propositional forms and the manner in which these propositional forms are combined into argument forms.

C. Aristotelian Logic

A system of logic provides us with a way of representing propositions and their combinations into arguments so that it is possible to decide whether an argument so represented is acceptable or unacceptable. In this text, we introduce two generic systems of logic: Deductive logic and Inductive logic. Deductive logic is the primary model of reasoning used in mathematics, science, and legal proceedings. It has long been considered the gold standard of reasoning, in that a deductively sound argument is able to force agreement, even if the proposition agreed to is distasteful. Though many might intuitively reject the claim that all women are animals, if they accept the premises that all women are humans and all humans are animals, they are nonetheless forced to acknowledge that all women are animals.

For good deductive arguments, if the premises are true then the conclusion must be true. But with good inductive arguments, if the premises are true, the conclusion is not necessarily true, but only more probably true. The conclusion of an inductive argument is never guaranteed, even when all available evidence supports the conclusion. Inductive arguments are most prominent in probability, statistics, and the experimental sciences. We will explore the basic elements of inductive logic in Chapter 6. Chapters 2, 3, 4, and 5 will explore developments in deductive logic from its beginnings in Aristotle to the development of modern computers.

The first system of deductive logic to be introduced in this text is called categorical (or Aristotelian) logic. It is a notation system in which propositions are represented as combinations of two categories of things – the subject class and the predicate class. An example would be the (false) proposition “All dogs are cats”, where ‘dogs’ is the subject class and ‘cats’ is the predicate class. In terms of this system, every proposition has one of the following categorical propositional forms (no matter what the statement is about):

A: All S are P’s

E: No S are P

I: Some S are P

O: Some S are not P

Following are some propositions which have A forms:

All jobs are wonderful.

All human beings are animals.

All flowers are plants.

All businessmen are honest.

Following are some propositions with E forms:

No freeloaders are people who will reside in my house.

No dogs are cats.

No lawyers are judges.

No mothers are women.

Following are some propositions which have I forms:

Some horses are big.

Some dogs are vicious.

Some cats are fish.

Some quarks are charmed.

Following are some propositions with O forms:

Some engines are not efficient.

Some dogs are not animals.

Some advertisements are not truthful.

Some men are not human.

It is important to remember that the form that a proposition has is independent of what that proposition is about and, therefore, independent of whether it is true or false. Form does not determine content, and content is independent of form. Following are some valid argument forms expressed in the categorical or Aristotelian system of logic:

All A are B

All B are C

All A are C

All J are K

No K are L.

No J are L

Some S are M

All M are P.

Some S are P

All A are B

Some A are not C.

Some B are not C

1.C.1. Exercises on Recognizing Categorical Propositions

For each of the following categorical propositions, (1) indicate its truth-value by writing T if the proposition is true and F if the proposition is false, and (2) write out the form of the proposition.

	Truth-Value	Categorical Form
1. All dogs are animals.	<u> T </u>	<u>All D are A</u>
2. No animals are insects.	<u> </u>	<u> </u>
3. All fish are living things	<u> </u>	<u> </u>
4. Some living things are fish.	<u> </u>	<u> </u>
5. No living things are insects.	<u> </u>	<u> </u>
6. Some rocks are not living.	<u> T </u>	<u>Some R are not L</u>
7. Some rocks are living.	<u> </u>	<u> </u>
8. Some dogs are living things.	<u> </u>	<u> </u>
9. All living things are animals.	<u> </u>	<u> </u>
10. Some fish are not living.	<u> </u>	<u> </u>

1.C.2. Exercises on Constructing Categorical Propositions:

Using the following class concepts, construct two true and two false propositions for each of the propositional forms indicated.

Class Concepts: round things, brown things, dogs, cats, lizards, canines, felines, reptiles, mammals, animals.

Truth-Value	Categorical Form	
(T)	All S are P.	_____
(T)	All S are P.	_____
(F)	All S are P.	<u>All round things are brown things.</u>
(F)	All S are P.	_____
(T)	No S are P.	_____
(T)	No S are P.	_____
(F)	No S are P.	_____
(F)	No S are P.	_____
(F)	Some S are P.	_____
(F)	Some S are P.	_____
(T)	Some S are P.	_____
(T)	Some S are P.	_____
(F)	Some S are not P.	_____
F)	Some S are not P.	<u>Some dogs are not canines.</u>
(T)	Some S are not P.	_____
(T)	Some S are not P.	_____

1.C.3. Exercises on Recognizing Argument Forms:

For each of the following arguments, write out its argument form.

argument:

1. All dogs are animals.
No animals are insects.
No dogs are insects.
2. All fish are living things.
Some living things are eaten.
Some fish are eaten.
3. No rocks are living things.
All living things are capable of feeling.
No rocks are capable of feeling.
4. Some dogs are living things.
Some living things are cats.
Some dogs are cats.
5. Some fish are not living things.
Some living things are not dogs.
No fish are dogs.
6. No elephants are human beings.
No human beings are mice.
No elephants are mice.
7. All deer are mammals.
All human beings are mammals.
All deer are human beings.

form:

All D are A
No A are I.
No D are I

D. Validity, Invalidity, and Refutations

Valid deductive arguments present premises which, if accepted, require that a certain conclusion also be accepted. But though a person may intend for the truth of a certain proposition to be conclusively established by the truth of the premises offered, this intention is not always realized. Consider the following argument:

Jones must be a Nazi because all Nazis hate Jews and Jones hates Jews.

Although the intention here obviously is to establish the truth of the proposition, “Jones is a Nazi,” the truth of that proposition does not follow from the truth of the premises given. This can be more clearly seen if the argument is put in standard form:

- (a₁) All Nazis are people who hate Jews.
Jones is a person who hates Jews.
Jones is a Nazi.

The argument has the same argument form as the following argument:

- (a₂) All tigers are animals that eat meat.
Barack Obama is an animal that eats meat.
Barack Obama is a tiger.

In each argument, the argument form is:

- (a₃) All A are B
x is B
x is A

In both cases, the premises might be true, but the conclusion does not necessarily follow. It may be true that all KKK members hate African Americans and it may be true that Jones hates

African Americans; however it does not necessarily follow that Jones must be a KKK member. Likewise, though it may be true that all tigers eat meat and it may be true that Barack Obama eats meat, it does not necessarily follow that Barack Obama is a tiger.

A deductive argument is one in which the maker of the argument intends for the truth of the conclusion to follow necessarily from the truth of the premises. Thus, if you accept the premises to be true, you must accept the conclusion to be true. But this intention cannot be realized if the maker uses an argument form from which it is possible to construct an argument where the premises are true but the conclusion is false.

DEFINITIONS

Valid Argument-- An argument is deductively valid if it has an argument form such that all arguments with that form transfer truth from premises to conclusion.

Invalid Argument-- An argument is deductively invalid if it has an argument form such that it is possible for an argument to exist with that form, yet have true premises and a false conclusion.

The development of procedures for deciding when an argument is valid or invalid is a central function of any system of deductive logic. A deductive argument is invalid when the truth of the premises of the argument does not establish the truth of the indicated conclusion. Unfortunately, when a conclusion is already known to be true independently of the truth of the premises offered, it is not always easy to see the faultiness of the argument. This is illustrated by the following categorical examples:

- (c₁) All dogs are canines.
Some canines are vicious.
Some dogs are vicious.

- (c₂) All guns are weapons,
Some weapons are used illegally.
Some guns are used illegally.

In each of these arguments, both the premises and the conclusion are true. Yet, neither (c₁) nor (c₂) is a valid argument because each has the following argument form, which is invalid:

- (c) All A are B.
Some B are C.
Some A are C.

A technique commonly used to prove that an argument is invalid is to construct a different argument with exactly the same form as the argument in question, but where the premises are already known to be true and the conclusion is already known to be false. Such an example demonstrates that, for all arguments of a similar form, the truth of the premises does not guarantee the truth of the conclusion. Thus, the following argument proves that the arguments (c₁) and (c₂) are invalid:

- (c₃) All dogs are animals.
Some animals are cats.
Some dogs are cats.

This argument has exactly the same form as (c₁) and (c₂). Yet, it is obvious here that the truth of the conclusion does not follow from the truth of the premises because, though in fact the premises are true, in fact, the conclusion is false. Arguing that the conclusion of (c₁) followed from the truth of its premises would be like arguing that the truth of the conclusion of (c₃) had to follow from the truth of the premises of (c₃).

The technique above involves producing a **refutation by analogy**. Thus, given a particular argument:

- (e₁) No Muslims are Christians.
No Christians are Hindu.
No Muslims are Hindu.

Refutation by analogy involves extracting the form of that argument:

- (e) No A are B.
No B are C.
No A are C.

and producing another argument having exactly the same form but where the premises are obviously true and the conclusion obviously false:

- (e₂) No babies are adults.
No adults are children.
No babies are children.

or

- (e₃) No men are elephants.
No elephants are human.
No men are human.

Both (e₂) and (e₃) have exactly the same form as (e₁), so that if the premises of (e₁) are taken as establishing the truth of its conclusion, then the premises of (e₂) and (e₃) should be taken as establishing the truth of their respective conclusions. But this could not be because we already know that the conclusions of (e₂) and (e₃) are false. As we will see in chpt.4, refutations by analogy are similarly constructed in the system of truth functional logic.

1.D.1. Exercises on Categorical Forms:

For each of the following invalid arguments, (a) specify the form of the argument and (b) construct a refutation by analogy using the following class concepts (p. 17):

Example: No dogs are cats.
 No cats are rats.
 No dogs are rats.

argument form

No A are B.

No B are C.

No A are C.

refutation

No dogs are felines. (T)

No felines are canines. (T)

No dogs are canines. (F)

1. Some gangsters are not educated.
 Some educated people are not honest.
 Some gangsters are not honest.

a. argument form

b. refutation

2. No horses are fish.
 All fish are scaly.
 No horses are scaly.

a. argument form

b. refutation

3. All cats are felines.

All cats are animals.

All felines are animals.

a. argument form

b. refutation

4. Some students are serious people.

Some serious people are very nice.

Some students are very nice.

a. argument form

b. refutation

E. Validity and Soundness

When we accept an argument, we do so believing that the argument is sound. A **sound deductive argument** is one where we accept its premises as true and the relationship between the premises and conclusion is such that it is impossible for the premises to be true and the conclusion false. A primary objective of this book is to clarify how to determine when the relationship between premises and conclusion is such as to imply the truth of the conclusion, given premises that are true. Thus, if we assume it true that all dogs are canines and we assume it true that all canines are mammals, then we must accept it as true that all dogs are mammals. This argument has the form:

- (g₁) All dogs are canines.
All canines are mammals.
All dogs are mammals.

This kind of a relationship between the premises of an argument and the conclusion of an argument is what is referred to when we say that an argument is valid. It means that acceptance of the premises requires acceptance of the conclusion. Thus, the following argument is also a valid argument:

- (g₂) All dogs are cats.
All cats are rats.
All dogs are rats.

Arguments (g₁) and (g₂) have the common form (g):

- (g) All A are B
All B are C.
All A are C

Argument (g_2) is a valid argument because if we accept the premises to be true, then we would have to accept the conclusion as being true. The difference between (g_1) and (g_2) is that, in (g_1), we do in fact accept the premises of that argument to be true, whereas with argument (g_2) in fact, we do not accept the premises of that argument to be true. But it is only because we do not accept the premises of (g_2) to be true that we can avoid having to accept its conclusion as true. While (g_2) is a valid argument, it is not a sound argument.

Definitions:

A deductive argument is SOUND if:

- (1) it has a valid argument form and
- (2) all of its premises are true.

A deductive argument is FALLACIOUS if:

- (1) it has an invalid argument form or
- (2) it has at least one false premise.

Irrespective of what a deductive argument may be about, if it has a valid argument form and if the premises are true, then it is impossible for the conclusion to be false. Thus, if it were true that all dogs are cats, and all cats are rats, then it would be impossible for there to be a dog which was not a rat. Thus, any argument with the same form as (g) would be a valid argument.

1.E.1. Exercises on Constructing Sound and Unsound Arguments

Each of the following Argument Forms is Valid. For each, construct one sound and one unsound argument having the same form:

i. Categorical Forms

1. All X are Y Sound: Unsound:
All Y are Z
All X are Z

2. All X are Y Sound: Unsound:
No Y are Z
No X are Z

3. All X are Y Sound: Unsound:
Some X are not Z
Some Y are not Z

4. No B are C Sound: Unsound:
Some A are C
Some A are not B

5. All P are Q Sound : Unsound:
Some P are R
Some Q are R

F. Truth-Functional Logic

The second system of deductive logic to be discussed in this text is called Truth-Functional (or modern) logic. This system begins with **simple propositions** that do not contain other propositions, and represents them by alphabets such as “p,” “q,” and “r.” These simple propositions are then combined by logical connectives such as “and,” “or,” “if-then,” and “not” into **compound propositions** with the following kinds of propositional forms:

conditional - if p then q

conjunction - p and q

disjunction - p or q

negation - not-q

Following are some compound propositions that have **conditional** forms:

If John goes to town, then Tom will go to town.

If it is raining outside, then there are clouds in the sky.

If the water is boiling, then the water is hot.

If the economy expands, then unemployment will increase.

Following are some compound propositions that have **conjunctive** forms:

John is going to town and Tom will go to town.

It is raining outside and there are clouds in the sky.

The water is boiling and the water is hot.

The economy will expand and unemployment will increase.

Following are some propositions that have **disjunctive** forms:

- John is going to town or Tom is going to town.
- It is raining outside or it is snowing outside.
- The water is boiling or the water is hot.
- The economy is expanding or unemployment will increase.

Following are some propositions that have **negation** forms:

- It is false that today is Saturday.
- I am not asleep.
- The water is not hot.
- It is not the case that unemployment will increase.

Propositions with these kinds of forms are then used to construct all the argument forms in the system. Some basic argument forms are:

If p then q	If it is raining outside then there are clouds in the sky.
<u>p</u>	<u>It is raining outside.</u>
q	There are clouds in the sky.

If p then q	If the water is boiling then the water is hot.
<u>not q</u>	<u>The water is not hot.</u>
not p	The water is not boiling.

p or q	The economy is expanding or unemployment will increase.
<u>not p</u>	<u>The economy is not expanding.</u>
q	Unemployment will increase.

It is important to remember that the variables in categorical and truth-functional logic take different kinds of values: a variable used in the system of categorical logic represents a certain class of things, while a variable used in the truth functional system represents a complete proposition.

F.1. Exercises on Recognizing Truth Functional Propositions:

For each of the following propositions, use the following legend to state its propositional form and indicate whether the proposition is true or false:

Ax = this month is x. Bx = last month is x. Cx = next month is x.

m₁=January m₂=February m₃=March m₄=April m₅=May m₆=June m₇=July
 m₈=August m₉=September m₁₀=October m₁₁=November m₁₂=December

Proposition	Propositional Form	Truth -Value
1. If this month is January then next month is November.	<u>If Am₁ then Cm₁₁</u> _____	<u>F</u>
2. If this month is January then next month is not November.		
3. This month is March or this month is June.		
5. If next month is November and last month was September then this month is October.		

- 6. This month is July and this month is not July.

- 7. This month is May or this month is not May.

- 8. It is not the case that if next month is November then this month is January. not - (if $C_{m_{11}}$ then A_{m_1}) _____ T

- 9. This month is not January and if next month is November then this month is October.

1.F.2. Exercises on Constructing Truth-Functional Propositions

Represent the class of days as follows: (Sunday = d_1 , Monday = d_2 , Tuesday = d_3 , Wednesday = d_4 , Thursday = d_5 , Friday = d_6 , Saturday = d_7)

Let S_x , T_x , and U_x be abbreviations for the following statement forms:

- S_x = Yesterday was x.
- T_x = Today is x.
- U_x = Tomorrow is x.

Then the following examples have the abbreviated statement forms and truth-values indicated:

Statement	Propositional Form	Statement Form	Truth-value
1. Today is Sunday or Yesterday was not Saturday	p or not- q	Td_1 or not- Sd_7	T

2. If tomorrow is Monday

then today is Thursday

If p then q

If Ud_2 then Td_5

F

1.F.3. Exercises on Constructing Truth-Functional Propositions:

Replacing x with $d_1, d_2, d_3, d_4, d_5, d_6,$ or d_7 to make statements from $Sx, Tx,$ and $Ux,$ construct one true and one false statement for each of the following truth functional propositional forms:

Truth Value	Propositional Form	Statement Form
T	p and q	
F	p and q	Sd_3 and Td_5
T	p or q	
F	p or q	
T	not-p	
F	not-q	
T	if p then q	If T d_5 then Ud_6
F	if p then q	

1.F.4. Exercises on Argument Forms:

For each of the following arguments, write out its argument form:

Argument -

Form

1. If today is Monday then yesterday was not Saturday.

If Td₂ then not-Sd₇

Today is Monday.

Td₂_____

Yesterday was not Saturday.

Not-Sd₇

2. Tomorrow is Wednesday or tomorrow is Thursday.

Tomorrow is not Wednesday._____

Tomorrow is Thursday.

3. If today is Friday then tomorrow is Saturday.

It is not the case that tomorrow is Saturday.

It is not the case that today is Friday.

4. Today is Monday or today is Tuesday.

Today is not Tuesday.

Today is not Monday

5. If (today is Wednesday or today is Thursday)
then (yesterday was not Sunday and yesterday
was not Monday).

Today is Wednesday.

Yesterday was not Sunday and was not Monday.

G. Validity, Invalidity, and Refutations

Valid deductive arguments present premises which, if accepted, require that a certain conclusion also be accepted. But though a person may intend for the truth of a certain proposition to be conclusively established by the truth of the premises offered, this intention is not always realized. In truth-functional form, we might be given the following argument:

Jones must be a Nazi because if somebody is a Nazi then they hate Jewish people and Jones certainly hates Jewish people.

As before, the intention is to establish the truth of the proposition “Jones is a Nazi.” The argument has the following standard form:

- (b₁) If Jones is a Nazi then Jones hates Jewish people.
- Jones hates Jewish people.
- Jones is a Nazi.

Its argument form is:

- (b) If p then q
- q_____
- p

This is also the form of the following argument:

- (b₂) If Lady Gaga is a man then Lady Gaga is a human being.
- Lady Gaga is a human being._____
- Lady Gaga is a man.

Argument (b₂) shows that in arguments of the form given by (b), the truth of the premises is not necessarily transferred to the conclusion, so that the premises of an argument of form (b) may be true, but the conclusion false. This means that the form of such arguments is itself not sufficient to guarantee that the truths of its premises are necessarily transferred to its conclusion. The form does not guarantee that true premises lead to true conclusions.

A deductive argument is one in which the maker of the argument intends for the truth of the conclusion to follow necessarily from the truth of the premises. Thus, if you accept the premises to be true, you must accept the conclusion to be true. But this intention cannot be realized if the maker uses an argument form from which an argument can be constructed where the premises are true but the conclusion is false.

DEFINITIONS

Valid Argument-- An argument is deductively valid if it has an argument form such that **all** arguments with that form transfer truth from premises to conclusion.

Invalid Argument-- An argument is deductively invalid if there is an argument with the same form where the premises are true and the conclusion is false.

A deductive argument is invalid when the truth of the premises of the argument does not establish the truth of the indicated conclusion. Unfortunately, when a conclusion is already known to be true independently of the truth of the premises offered, it is not always easy to see the faultiness of the argument. The development of procedures for deciding when an argument is invalid is a central feature of both categorical and truth-functional logic. This is illustrated in the following examples:

- (d₁) If Paris, France is in the USA then Paris, France
is in North America
Paris, France is **not** in the USA.
Paris, France is not in North America.

(d₂) If Jay Z is a lion then Jay Z is a feline.

Jay Z is not a lion.

Jay Z is not a feline.

In each of these arguments, the premises and the conclusion are true. Yet neither argument is valid because they share a common argument form, which is invalid:

(d) If p then q

not p

not q

The invalidity of **(d)** is shown by the following argument:

(d₃) If Barack Obama is a woman then Barack Obama is a human being.

Barack Obama is not a woman.

Barack Obama is not a human being.

It is certainly true that if Barack Obama is a woman then Barack Obama is a human being. And if Barack Obama is in fact a man, then it is also true that Barack Obama is not a woman. But if in fact Barack Obama is a man then it is certainly false that Barack Obama is not a human being. Thus, the premises of (d₃) would be true yet its conclusion false. This proves that any argument of form (d) fails to transfer truth from premises to conclusion. (d₃) is a **refutation by analogy of (d)**.

Thus, given the following argument:

- (f₁) If Washington, D.C. is not in Europe, then Washington, D.C. is not in France.
Washington, D.C. is not in France.
Washington, D. C. is not in Europe.

a refutation is produced by extracting its form

- (f) If not-p then not-q
not-q
not-p

and producing another argument with the same form but where the premises are true and the conclusion is false:

- (f₂) If Barack Obama is not human then Barack Obama is not a mother.
Barack Obama is not a mother
Barack Obama is not human

An invalid argument is one where the truth of its conclusion is not necessitated by the truth of its premises. The conclusion of an invalid argument may be true but it is not because the premises of that argument are true. When the conclusion of an invalid argument is true, its truth derives from information that is not included in the premises of that argument.

1.G.1. Exercises on Truth Functional Forms:

For each of the following invalid arguments: (a) specify the truth-functional form of the argument; and (b) construct a refutation by analogy.

1. If today is Monday then tomorrow is Tuesday.

Today is not Monday.

Tomorrow is not Tuesday.

form:

refutation:

If p then q

If BO is a woman then BO is a human.

not-p

BO is not a woman

not-q

BO is not a human

2. If Bill has had his morning coffee then Bill is not be sleepy.

Bill is not sleepy.

Bill has had his morning coffee

form:

refutation:

3. Either Susan is the murderer or Susan is being framed.

Susan is not the murderer.

Susan is not being framed.

form:

refutation:

4. If Mary does not get a raise then Mary will quit her job.

Mary does get a raise.

Mary will not quit her job.

form:

refutation:

more exercises needed

H. Sound Deductive Arguments

When we accept an argument, we do so believing that the argument is sound. A sound deductive argument is one where we accept its premises as true and the relationship between the premises and conclusion is such that it is impossible for the premises to be true and the conclusion false. A primary objective of logic is to clarify how to determine when the relationship between premises and conclusion is such as to imply the truth of the conclusion, given premises that are true.

Definitions :

A deductive argument is SOUND if:

- (1) it has a valid argument form and
- (2) all of its premises are true.

A deductive argument is FALLACIOUS if:

- (1) it has an invalid argument form or
- (2) it has at least one false premise.

1.H.i Exercises on Constructing Sound and Unsound Arguments:

Each of the following Argument Forms is valid. For each, construct one sound and one unsound argument having the same form:

ii. Truth Functional Forms

1. If p then q

not-q

not-p

Sound:

Unsound

- | | | |
|---|---------|---------|
| 2. If not-p then not-q
<u>not-p</u>
not-q | Sound | Unsound |
| 3. Either not-p or not-q
<u>q</u>
not-p | Sound: | Unsound |
| 4. If p then not-q
<u>q</u>
not-p | Sound : | Unsound |
| 5. If not-p then q
<u>not-q</u>
p | Sound: | Unsound |

1.H.1. Exercises:

Indicate, for each of the following statements, whether it is true (**T**), or false (**F**).

1. If an argument is valid, then the truth of the premises necessarily implies the truth of the conclusion. _____

2. An argument is invalid if any other argument of identical logical form can have true premises and a false conclusion. _____

3. An unsound argument must be invalid. _____
4. A sound argument must have true premises. _____
5. An unsound argument must have two false premises. _____
6. An unsound argument must have a false conclusion. _____
7. An unsound argument must have one false premise. _____
8. A refutation of an invalid argument must have a false premise. _____
9. A refutation of an invalid argument must have a false conclusion. _____
10. An argument is valid if the truth of the conclusion of the argument (or any argument of identical logical form) is necessarily determined by the truth of the premises of the argument. _____

CHAPTER 2

CATEGORICAL PROPOSITIONS

A. The Structure of Categorical Propositions

To "categorize" a person, place, time, thing, or situation is to characterize it as a member of a class of similar things. One does not consider the thing in question from its purely individual point of view, that is, in terms of the qualities it has without relationship to any other things. Upon being categorized, an individual thing is known by properties that it has by virtue of its being a member of the class of things referred to by that category. All propositions expressed in the Aristotelian system of logic are called categorical propositions because they are constructed using two categories of things: the **subject category** (or class) and the **predicate category** (or class). The copula, or connector between the subject and predicate, of a categorical proposition indicates how its subject category is related to its predicate category. The copula specifies whether members of the subject category are also members of the predicate category or whether members of the subject category are not members of the predicate category. Illustration:

<u>Subject</u>	<u>Copula</u>	<u>Predicate</u>	<u>Quality of Copula</u>
(1) Strawberries	are	red.	Affirmative
(2) Strawberries	are not	red.	Negative

However, this is not enough. (1) declares that members of the class of strawberries are also members of the class of red things, but (1) is ambiguous because it does not specify the quantity of the subject class that is included in the predicate class. Thus, Ms. A might take (1) to mean "all strawberries are red," while Mr. B might take (1) to mean "some strawberries are red." Ms. A and Mr. B would then be in disagreement over the truth or falsity of (1). Ms. A declares (1) false because she believes that "all strawberries are red"

is false, while Mr. B declares (1) true because he believes the statement, “some strawberries are red” is true. Statement (2) is equally ambiguous. Ms. A might consider (2) true because she believes that “some strawberries are not red” is true, while Mr. B might consider (2) to be false because he believes that “no strawberries are red” is false.

Many arguments develop because two parties interpret an ambiguous statement in different ways. Such arguments are really pseudo-disagreements, because the disputing parties are not taking opposite sides to the same claim. By filling in missing information in different ways, as in (1) and (2) above, one party may argue that the statement in question is true, while the other party argues that the statement in question is false. To avoid such pseudo-disagreements and pseudo-agreements, any statement expressed as a categorical proposition must specify the following elements in the order indicated:

QUANTITY....SUBJECT....COPULA....PREDICATE

The quantity specifies how much of the subject is being included in or not included in the predicate class. Either all or some of the subject is included in the predicate. Thus, for (1) above, the two possibilities become:

A: All strawberries are red.

I: Some strawberries are red.

And the two possibilities for (2) above become

E: All strawberries are not red.

O: Some strawberries are not red.

Presented in this way, the A, E, I, and O propositions exhibit an informative symmetry. The A and E propositions say something about every strawberry in the universe, and so are called Universal propositions. The I and O propositions refer only to part of the entire

class of strawberries, and so are called Particular propositions. The copula of the A and I propositions affirms the inclusion of members of the subject class in the predicate class, while the copula of the E and O propositions denies inclusion of members of the subject class in the predicate class. We describe this by saying that the quality of the copula in the A and I propositions is Affirmative while the quality of the copula in the E and O propositions is Negative. It is now possible to describe any categorical proposition in terms of the quantity of its subject and the quality of its copula:

A: All S are P	Universal Affirmative
E: All S are not P	Universal Negative
I: Some S are P	Particular Affirmative
O: Some S are not P	Particular Negative

We began by specifying the structure of propositions in terms of subject, copula, and predicate, and we saw that propositions expressed in this manner were ambiguous. In order to eliminate ambiguities that might lead to needless conflict, specification of the quantity is required. Nonetheless, we still have not eliminated a remaining structural feature leading to ambiguity. This problem arises from the way in which the E proposition is expressed. To illustrate, consider the following E proposition:

(3) All strawberries are not red.

Two individuals might disagree over the truth and falsity of (3) because they each take it to mean something different. Mr. A may take (3) to be true because he knows from experience that “some strawberries are not red” is true. On the other hand, Mr. B may take (3) to be false because he knows from experience that to say of all strawberries that they are not red (i.e., that no strawberries in the universe are red) is to say something that is false. Thus, Mr. A could insist that “all strawberries are not red” is true while Mr. B could insist that “all strawberries are not red” is false. Here again, we have a pseudo-disagreement because (3) is ambiguous and one party takes it to mean one thing while the other party takes it to mean a different thing.

Any statement of the form “All S are not P” is ambiguous. In some context it could mean “Some S are not P,” while in other contexts it could mean that “No S are P”:

E: All S are not P

is ambiguous between

E₁: No S are P

E₂: Some S are not P

Since this ambiguity is possible whenever we use the form “All S are not P,” that form is banished. Any speaker using it must specify whether it means E₁ or E₂. And, since E₂ is the same as the O proposition, any speaker who intends to assert a universal negative proposition must use the E₁ form. Thus, the legitimate categorical propositional forms are:

A: All S are P	Universal Affirmative
E: No S are P	Universal Negative
I: Some S are P	Particular Affirmative
O: Some S are not P	Particular Negative

While “No S are P” may look as if it has an affirmative form, as the A and I propositions do, this is merely an accidental similarity. Essentially, the copula of the E proposition is like that of the O proposition. In linguistic terms, the E and O propositions have similar deep structures because they both have negative copulas, but different surface structures. In biology, this would be similar to the case of individuals who have the same genotype, or species, but different phenotypes, the sum total of qualities.

2.A.1. Exercises on Form, Quantity, and Quality:

Give the form (A, E, I, O), Quantity (Universal, Particular), and Quality (Affirmative, Negative) of the following propositions and underline the copula.

	FORM	QUANTITY	QUALITY
1. Every student who is registered in college is very highly motivated.	_____	_____	_____
2. Some of the propositions which are presented in this course are not meant to make good sense.	_____	_____	_____
3. None of the people who are elected to public office are honest.	_____	_____	_____
4. Some musicians are people who are not satisfied with present conditions.	_____	_____	_____
5. Nothing I do is intended to hurt you.	_____	_____	_____
6. Some things that are not grown on a farm are available in today's supermarkets.	_____	_____	_____

	FORM	QUANTITY	QUALITY
7. Some people who are in college for an education are not worried about what other people think of them.	_____	_____	_____
8. All you ever do is complain about what other people are not doing to help you.	_____	_____	_____
9. Some people who are not intimidated by rhetoric or threats are able to achieve something worthwhile in life.	_____	_____	_____
10. All drivers of automobiles which are not safe are desperadoes who threaten the lives of their fellow men.	_____	_____	_____
11. Some politicians who could not be elected to the most minor positions are appointed officials in our government today.	_____	_____	_____

12. No men who have not themselves
 done creative work in the arts
 are responsible critics on whose
 judgments we can rely. _____ _____ _____

13. Some drugs which are very effective
 when they are properly
 administered are not safe
 remedies that all medicine
 cabinets should contain. _____ _____ _____

B. Definitions

The use of the system of Aristotelian logic requires that one construct phrases which clearly designate the class of things referred to by the subject and the class of things referred to by the predicate. In order to accomplish this, the subject term and the predicate term must be as unambiguous and precise as possible. Some of the most common fallacies in reasoning arise from terms used in an argument which are either ambiguous or vague. Consider, for instance, the following argument:

All poor students are students who will not be admitted to law school.

Smith is a poor student._____

Smith is a student who will not be admitted to law school.

The conclusion that Smith is a student who will not be admitted to law school appears to follow only because the term “poor student” is taken to refer to the same class of students

in both premises. If, however, it is used in the first premise to refer to the class of students who make less than average grades, while it is used in the second premise to refer to the class of students who have inadequate financial resources, then the conclusion obviously does not follow.

In constructing and evaluating arguments, it is critical that the terms used in the arguments be clarified so that ambiguities and vague references are eliminated. Otherwise, we risk misleading, and being misled by such terms to draw conclusions that do not really follow. We clarify the meaning of a subject or predicate term by giving either its denotative meaning or its connotative meaning or both.

The **denotative meaning** of a term is given by referring directly to an actual individual in the class to which the term applies. Thus, we might indicate what a dog is by pointing to one. The complete set of all individuals to which the term applies is called the **extension** of the term. Thus, the extension of the term "dog" is all of the things to which the term can appropriately be applied. Likewise, the extension of the term "airport" is all of the places to which the term can appropriately be applied, and includes Kennedy Airport in New York, NY, National Airport in Washington, DC, O'Hare Airport in Chicago, IL, and Charles DeGaulle Airport in Paris, France. Likewise, the extension of the term "alcoholic beverage" is all beverages to which that term is correctly applied, and includes all specific instances of beverages containing gin, beer, wine, vodka, bourbon, etc.

The **connotative meaning** of a term refers to the set of qualities, properties, or characteristics shared by all the objects to which the term correctly applies. This set of attributes is called the **intension** of the term. Thus, the connotative meaning of the term "dog" is "domesticated canine mammals and their progeny". And the connotative meaning of the term "airport" is "tract of land or water which is maintained for the landing and takeoff of airplanes and for receiving and discharging passengers and cargo, and usually has facilities for the shelter, supply, and repair of airplanes." Likewise, the connotative meaning of "alcoholic beverage" is "any beverage containing a colorless, volatile, flammable liquid with chemical composition C_2H_5OH and intoxicating

properties.” The property of being suitable for the landing and takeoff of airplanes is a property shared by all airports, and is thus an essential part of the connotative meaning of the term “airport.” The property of containing a liquid with the chemical composition C_2H_5OH is a property shared by all alcoholic beverages, and is, thus, an essential part of the connotative meaning of the term “alcoholic beverage.”

Methods of Definition

The term to be defined is called the **definiendum** and the definition offered to clarify that term is called the **definiens**. From the two kinds of meaning introduced, denotative and connotative, we derive two kinds of definition.

I. Denotative Definition

Producing or pointing to an actual example of a term we are using is one of the most elementary ways of clarifying the meaning of a term. It is the way that most of us initially learn our native language. Pointing to an example of a term is called an **ostensive definition** of that term. However, such forms of definition are limited by considerations such as the following:

1. In many cases it is impossible to point to each member of the extension of a term. Yet, we are expected to apply the term to new cases where appropriate.
2. A given thing may be an example of many different terms, and pointing or referring to that example does not distinguish between the meanings of the different terms. Thus, we may refer to Martin Luther King Jr. as an example of a civil rights leader, as an example of a minister, as an example of an African-American, and as an example of a husband. Yet, the terms “civil rights leader,”

“minister,” “African-American,” and “husband” certainly do not all mean the same thing.

3. Finally, some terms do not have sensible objects as members of its extension. It is impossible, for instance, to point to an actual example of heaven or zero. Yet, this does not mean that the terms “heaven” and “zero” are meaningless. For the meaning of a term can be given not only by denotation, but also by connotation.

II. Connotative Definition

The connotative definition of a term presents the properties that identify it and distinguish it from other terms. The properties which define a term are classified as either part of its genus or part of its difference. The genus is that characteristic or set of characteristics that describes the general class to which a term belongs. The term being defined is always a subclass of the more general class given by the genus, and the property or set of properties that distinguishes it from other subclasses of the same genus is called the difference. The class whose membership is divided into subclasses is called the genus class, and the subclasses under it are called its species.

Let us take the examples we have used earlier to illustrate the notions of genus and difference. "Airport" has as its genus "a tract of water or land." But to say that "airport" means "a tract of water or land" is, while correct, grossly inadequate and incomplete. For that property does not differentiate “airport” from “seaport” or “parking lot.” What distinguishes an airport from a seaport or a parking lot is the property of being maintained for the landing and takeoff of airplanes, the discharge of passengers and cargo from airplanes, and the supply, storage, and repair of airplanes on land. It is these latter properties that establish the specific difference between "airports" and other terms which have the same genus.

Likewise, while it is correct to say that an alcoholic beverage is a liquid, that is again an incomplete explication of its meaning. The term "alcoholic beverage" belongs to the

genus "liquids," but that does not distinguish a martini from a milkshake or water or a myriad of other substances, all of which fall under the genus "liquid." The property that marks the specific difference between alcoholic beverage and other liquids is the property of having an intoxicating, drinkable component with the chemical composition of C_2H_5OH .

Let us now define the term "college freshman" by the method of genus and difference. The genus class to which the term belongs is "undergraduate college student." But to say that a college freshman is an undergraduate college student does not differentiate it from a college sophomore, junior, or senior. To complete the definition we need to give the properties of the species "college freshman" that distinguishes it from other species of undergraduate college student (i.e., sophomore, junior, senior). In this case, the specific difference is the property of "having less than 30 semester hours of class credits".

Following is a list of the terms we have defined:

Definiendum

Definiens

Airport

a tract of land or water (genus) that is maintained for the landing and takeoff of airplanes, the receiving and discharging of passengers and cargo from airplanes, usually having facilities for the shelter, and supply and repair of airplanes (difference).

Alcoholic beverage

a liquid (genus) which is drinkable and contains an intoxicating component with the chemical composition C_2H_5OH (difference).

College freshman

an undergraduate college student (genus) who has less than 30 semester hours of class credits (difference).

As the examples given indicate, relative clauses are generally used to express the specific difference. The following kinds of connotative definitions are characterized by the nature of their specific differences:

Functional definitions are definitions where the specific difference is a particular use or function that the genus is put to. For example, a sextant is an instrument (genus) used for measuring distances using angles (difference).

Operational definitions are definitions where the specific difference is a public and repeatable procedure with specific outcomes. Thus, an alkaline liquid is a liquid (genus)/ which is such that if a piece of litmus paper is immersed in it then the litmus paper will turn blue.

Stipulative definitions introduce new terms as the definiendum, and stipulate the genus and difference that constitute their meaning. Thus, let "Gbal" be defined as a ball (genus)/ which is green (difference).

Theoretical definitions give the meaning of a term using the concepts peculiar to a particular scientific theory. Thus, "table salt" is defined as "sodium chloride."

Lexical definitions report the definitions given a term in standard dictionaries. For example, the term "blitzkrieg" is defined by Webster's dictionary to mean "warfare which is sudden, swift, large scale, offensive, and intended to win a quick victory."

Synonymous definitions give the meaning of a term by introducing another term with the same meaning. Thus, "krieg" means "war" in German and "noir" means "black" in French.

2.B.1. Exercise on Definitions: Give the definitions of the terms under "Definiendum" (numbered 1 through 19) by identifying under "Definiens" their appropriate genus (numbered 1 through 13) and difference (numbered 1 through 19).

Definiendum	Definiens	
	Genus	Difference
1. submarine	1. male	1. parent
2. bison	2. inflammation	2. writing
3. pen	3. animal	3. higher learning
4. hepatitis	4. institution	4. large
5. arthritis	5. man	5. heavenly bodies
6. bachelor	6. emperor	6. North American
7. czar	7. instrument	7. living things
8. astronomy	8. study	8. religion
9. biology	9. warship	9. human beings
10. theology	10. deer	10. society
11. sociology	11. woman	11. female
12. anthropology	12. buffalo	12. young
13. college	13. plant	13. married
14. seedling		14. operate under water
15. wife		15. Russian
16. stag		16. unmarried
17. doe		17. joint
18. father		18. liver
19. husband		19. male

2.B.2. Exercises on Definitions:

Identify the following definitions as synonymous, denotative or connotative:

1. A physician is a doctor.
2. The OPEC countries include Saudi Arabia, Kuwait, and Algeria.
3. Amphibians are any class of vertebrates that are born with gills but develop lungs as mature adults.
4. Amphibians are frogs, toads, newts and salamanders.
5. A toreador is a bullfighter.
6. Photosynthesis is the production in green plants of bio-chemical substances in the presence of light.
7. Dogs, wolves, jackals and foxes are canines.
8. Ursa Major means Great Bear.
9. Dialectical Materialism is the logical basis of Marxism.
10. Phlegmatic means sluggish, dull, apathetic.
11. A cannibal is a person who eats human flesh.
12. Alcoholic beverages are beer, wine, hard liquors and liqueurs.

13. A bassoon is a double-reed bass wood-wind instrument having a long curved stem attached to the mouthpiece.
14. Boyle's Law is a law in physics that states that for a body of ideal gas at constant temperature the volume is inversely proportional to the pressure.
15. An amulet is something worn on the body because of its supposed magic power to protect against injury and evil.
16. An amulet is a charm.
17. Cannelloni are tubular casings of dough filled with ground meat, baked and served in tomato sauce.
18. Metempsychosis means transmigration of the soul.
19. A PT boat is a small, fast, and armed boat used for coastal patrol and convoy.
20. Myopia means nearsightedness.
21. Sclerosis is a hardening of a tissue.
22. Agronomy is the theory and practice of field-crop production and soil management.
23. Acrophobia is the fear of being at a great height.
24. Paranoia is a chronic mental disorder characterized by systematized delusions of persecution and of one's own greatness.
25. Clairvoyance means discernment.

26. Clairvoyance is the ability to perceive objects not present to the senses but which have objective existence.
27. Marsupials are kangaroos, wombats, bandicoots, opossums, etc.
28. Marsupials are mammals that carry their young in a pouch.
29. A scimitar is a saber having a curved blade with the edge on the convex side and used chiefly by Muslims.
30. ESP means extra sensory perception.
31. A pentagon is a polygon with five sides.
32. *Gamba* means leg in Italian.
33. A snack is a small meal.
34. Tetanus is an infectious disease caused by the tetanus bacillus.

C. Rules for Definition by Genus and Difference

To construct correct definitions by genus and difference or to evaluate ones that are proposed, certain rules should be used as guides.

Rule 1. A definition should state the most essential properties of the term being defined.

A good connotative definition should be based on basic identifying properties of the members of a class being defined. If one were to define “man” as an animal that has been to the moon, it would be a violation of the rule since having gone to the moon is not essential to knowing what it means to be a man. Socrates was a man long before man had been to the moon.

Rule 2. The definition must not be too broad or too narrow.

An adequate definition should include all cases covered by the definiendum and only these cases. A definition is too broad if it includes cases or objects to which the term does not apply, and it is too narrow if it excludes cases or objects to which the term applies. Thus, the definition of "shoes" as a "covering for the feet" is too broad for it would include socks which are not shoes. And the definition of a "car" as a "Toyota" would clearly be too narrow for it excludes other examples of a car.

Rule 3. A definition should not be circular.

This rule states that a definition should not contain the term to be defined or its synonym. The reason is that a term that needs clarification cannot be its own means of clarification. For example, to define a philosopher as a person who philosophizes is a circular definition.

Rule 4. A definition should be expressed in clear and neutral language.

The purpose of a definition is to eliminate ambiguity and vagueness in a term. Therefore, we should use words that are plainer and more familiar to the listener than the term being defined. We should try to use literal language in definitions rather than figurative or metaphorical ones, for the latter are susceptible to varied interpretations. An example of figurative language in a definition is the definition of bread as "the staff of life." This may be good poetic language but is an unclear definition. Of course, the obscurity of a definition is a relative thing. It depends on the level of knowledge of the listener. For example, to define "holoblastic" as the "undergoing of complete cleavage into blastomeres" may be an obscure definition to non-specialists but perfectly intelligible to embryologists. We must also avoid the use of language with a slant or bias that is sarcastic, cynical or facetious. An objective definition tries to convey information rather than the emotions and prejudices of the speaker. Examples of biased or slanted definitions are: Marriage is a state of slavery. Welfare is a racket in which freeloaders take advantage of public charity.

Rule 5. A definition should, if possible, be expressed affirmatively rather than negatively.

Definitions are supposed to explain what a term means, not what the term does not mean. Hence, definitions must be expressed affirmatively whenever possible. Thus, to define the term "plutocracy" as a form of government that is not a democracy nor a monarchy is to fail to explain what the term means. Likewise, to define a woman as a person who is not a man tells us what a woman is not, but does not tell us what a woman is. Sometimes there are terms which are basically negative in meaning and, therefore, are best defined negatively. For example, a bachelor is an unmarried man; blindness is a state of being without sight; baldness is the state of not having hair on one's head, and so on. But even in these examples, there is an affirmative mention of the genus, though the difference is expressed negatively.

2.C.1. Exercises on Connotative Definitions:

Determine whether the following break any of the rules for a good connotative definition:

1. A comet is a heavenly body.
2. A weather vane is a meteorological instrument.
3. An abnormal person is one who acts abnormally.
4. A Republican is a person who favors big business.
5. Democracy is a form of government found in democratic countries.
6. A square is a plane figure with four equal sides and four right angles.
7. Beauty is the flower of virtue.
8. Beauty is the harmony of form.
9. Health is the absence of disease.
10. Abortion is the murder of innocent human beings.
11. Virtue is the opposite of vice.
12. Murder is the premeditated killing of an innocent person.
13. A policeman is a racist pig.
14. A male chauvinist is a man who thinks the opposite sex inferior.
15. Suicide is the killing of oneself.
16. Gold is a mineral that is neither silver nor iron.
17. Psychiatry is a pseudo-science that produces uncertain cures.
18. Woman is synonymous with folly.
19. Woman is the temptress of man.
20. Religion is an obsessional neurosis of mankind.

21. Religion is the opium of the people.
22. Christians are the salt of the earth.
23. Herpetology is a branch of zoology having to do with the study of reptiles and amphibians.
24. An altruist is a person foolishly sacrificing his interest for the sake of others.
25. An atheist is an immoral person who does not believe in God.
26. Man is an animal who laughs.
27. Man is a tool-making and tool-using animal.
28. A philanthropist is a person who practices philanthropy.
29. Darkness is the absence of light.
30. A jury is a group of people at a criminal trial.
31. Premarital sex is sexual intercourse between unmarried persons.
32. A hat is covering for the head.
33. Faith means reason blindly accepting propositions that cannot be proved.
34. An agnostic person is someone who is neither a theist nor an atheist.
35. A carpenter's square is a square used by a carpenter.
36. A violin is a stringed musical instrument played with a bow.
37. Feminism is a movement formed by a group of militant women who hate the admirable career of motherhood and being a housewife.
38. A chicken is a domesticated bird.
39. War is the dehumanizing use of armed violence between nations or parties within the state.
40. Feminism is a movement founded by a group of women who believe in the principle that women should have political, economic and social rights equal to those of men.

D. Translation From Ordinary Language to Categorical Form

Translating statements from ordinary language into categorical form is not always easy. There is no mechanical formula that can be applied in each case in order to make a correct translation. Yet, having to make a translation forces us to reflect on the meaning of the statement proposed and to separate sentiment from fact. To illustrate, consider the following statement:

(1) Ain't nobody going to help you in this world today.

While many might agree with the sentiment expressed by this statement, few would accept as fact the characterization of the world that the statement makes. What that characterization is, however, is not immediately obvious since it is not immediately obvious what the subject and what the predicate classes are that are being related.

Translating a statement into categorical form forces us to analyze and rephrase that statement in terms of quantity, subject, copula, and predicate. Rephrased in accordance with those parameters, (1) proposes that two classes of things are related in a certain manner: the class of things which are people in today's world (subject), and the class of things which will help you in today's world (predicate). The manner in which these classes are related is exemplified by the E form "No S are P." Thus, (1) translated into categorical form becomes:

(1a) No things which are people in today's world are things which will help you in today's world.

An alternative translation of (1) could be given by taking as its subject the class of "people in the world today" and as its predicate the class of "people that will help you"; and then relating these classes in accordance with the E form to express the proposition.

(1b) No people in the world today are people that will help you.

Both (1a) and (1b) are acceptable translations of (1) into categorical form. Of course, neither sounds natural. People don't ordinarily make statements like, "No people in the world today are people that will help you;" even less seldom would one hear a statement like, "No things which are people are things which will help you in the world today." Both (1a) and (1b) are propositions expressed in accordance with the structure of Aristotelian logic, but Aristotelian logic is not a natural language. Aristotelian logic is a formal language. And, while it does have an advantage over natural languages in making clear (a) what classes of things are being related by a statement and (b) how those classes are being related, economy of words is not one of its virtues.

Perhaps the closest analogue in everyday life to a formal language is the language of legal documents. In such documents, the parties involved and their relationship to one another must be spelled out as fully and specifically as possible, and in strict accordance with the form required by the legal system. In this way the chance for ambiguity, vagueness, and misunderstanding is reduced to a minimum; and systematic relationships can be clearly exhibited. It is similar with any formal system, and, in particular, with the system of Aristotelian logic. The subject class, the predicate class, and their relationship must be spelled out fully in accordance with the form prescribed by the system. In general, every formal system has certain advantages and certain disadvantages, depending on the context and the job to be accomplished. That is why there are many formal languages: the system suitable for one job may not be suitable for another.

To use the system of Aristotelian logic, one must construct phrases that clearly designate the class of things referred to by the subject and the class of things referred to by the predicate. As (1a) and (1b) illustrate, there is usually more than one correct way of doing this. Only after the subject and predicate have been characterized is it possible to choose the proper copula (is, is not, are, are not) and proper quantifier (all, no, some). To illustrate this again, if the subject of (1) had been phrased as "people in the world today" and the predicate phrased as "people that will not help you," then a correct translation of (1) would have been:

(1c) All people in the world today are people that will not help you.

The fact that (1a), (1b), and (1c) are all correct translations of (1) shows how there is no one correct translation for a given statement of ordinary language. But this does not mean that, for a given statement, all attempted translations are correct. It would be incorrect, for instance, to translate (1) by:

(1d) All people who will not help you are people in the world today.

(1d) does not preserve the meaning given by (1c). This is best seen by contrasting the form of (1c) with the form of (1d).

Form (1c): All S are P

Form (1d): All P are S

Often, when the proposition of the form "All S are P" is true, the corresponding proposition of the form "All P are S" is false. Thus, while "All women are human" is true, "All humans are women" is false.

The only cases in which "All S are P" means the same as "All P are S" are cases in which "P" provides a definition of "S". In such cases, the proposition "All S are P" is a tautology, a statement which is true by definition. In tautologies, both the subject and the predicate refer to the same class of things, as in "All bachelors are unmarried males." When statements are not true by definition, however, a proposition of the form "All S are P" does not generally mean the same as a proposition of the form "All P are S." "All mothers are female" does not mean that "All females are mothers".

In each of the categorical propositions (A, E, I, O), the meaning of the subject term and the meaning of the predicate term is best given by their **genus and difference**. The genus of both the subject and the predicate is the same, and denotes the general class of things of which the subject and predicate are subclasses. The difference of the subject term is that property (or set of properties) that distinguishes its extension from the extension of the predicate term.

Thus, in 1c (All people in the world today are people that will not help you) the genus for both subject and predicate term is "people"; and the property that distinguishes the predicate class is the property of being such "that will not help you." In 1b, (no people in the world today are people that will help you), the genus is again "people", and the subject's difference is "in the world today", but the predicate's difference is "that will help you." Finally, for "no things which are people are things which will help you in the world today", the genus is "things" and the specific difference for the subject is "which are people" and for the predicate is "which will help you in the world today." This is summarized in the following chart:

	Genus	<u>subject's difference</u>	<u>predicate's difference</u>
1a	things	which are people	which will help you in the world today
1b	people	in the world today	that will help you
1c	people	in the world today	that will not help you

In ordinary language, the genus of the subject and predicate term is often unstated. In order to give a clear and precise definition of the subject and predicate terms, however, it is important to rephrase them in terms of genus and difference.

Some items that typically translate into universal propositions are:

every; each; whenever; none; only; proper names; direct references

Following is a collection of examples of correct translation from ordinary language to universal categorical form. Each statement from ordinary language is numbered, and is followed by one or more correct translations.

1. Every Sunday I go to church.
 - 1a. All days which are Sunday are days that I go to church.

2. Each of my children has a pet.
 - 2a. All people who are my children are people who have a pet.

3. I love going to the beach.
 - 3a. All people that are me are people that love going to the beach.

4. Whenever I hear you coming I run and hide.
 - 4a. All times I hear you coming are times I run and hide.

5. None of her friends smoke.
 - 5a. No friend of hers is a friend who smokes.
 - 5b. No person who is her friend is a person who smokes.

6. Only lawyers become judges.
 - 6a. All people who become judges are people who are lawyers.

7. Only women are mothers.
 - 7a. All mothers are women.

8. Mayor Jenkins presides over the City Council.
 - 8a. All people that are Mayor Jenkins are people that preside over the City Council.

- 9a. Mary Jane won a medal.

All people that are Mary Jane are people who won a medal.

- 10a. That pencil on the table belongs to me.

All things that are "that pencil on the table" are things that belong to me.

While we may gain in clarity when the quantity of a statement is universal, we typically lose information when statements translate into particular propositions. A particular proposition is true if there is at least one individual in the subject class that is related to the predicate class in the manner indicated by the quality of the copula. If there is at least one such individual, then it is irrelevant whether there are many more or few more such individuals. This is illustrated by the following two statements:

- (1a) Most children don't like spinach.
- (1b) A few children don't like spinach.

Each of these statements could be translated into the categorical proposition:

- (1) Some people who are children are not people who like spinach.

While (1) makes clear that part of the class of children are not members of the class of people who like spinach, it fails to indicate how big a part. In ordinary language there are many ways of indicating how much of the subject class is being included in or excluded from the predicate class. Such information is lost when we translate into categorical form. Some words that typically translate into particular propositions are:

most; a few; few; a part of; a majority of; a minority of; a speck of; a heap of; most of; a little bit of; a portion of; x% of; many of.

The following is a collection of examples of translation from ordinary language to particular categorical form. Each statement from ordinary language is numbered and followed by one or more correct translations:

- 1. Most football fans drink beer.
 - 1a. Some people who are football fans are people who drink beer.

- 2. A majority of the American people voted for Barack Obama in the 2008 elections.
 - 2a. Some people who are American are people that voted for Barack Obama in the 2008 elections.

- 3. A minority of the world population consumes 60% of the world's resources.
 - 3a. Some people who are a minority of the world's population are people who consume 60% of the world's resources.

4. A speck of sugar fell on the floor.
 - 4a. Some thing which is a speck of sugar is a thing which fell on the floor.

5. A lot of wage earners don't pay taxes.
 - 5a. Some people who are wage earners are not people who pay taxes.
 - 5b. Some people who are wage earners are people who do not pay taxes.

6. A few fish can fly.
 - 6a. Some things which are fish are things which can fly.

7. Few fish can fly.
 - 7a. Some things which are fish are not things which can fly.

8. A few women are millionaires.
 - 8a. Some people who are women are people who are millionaires.

9. Few women are billionaires.
 - 9a. Some people who are women are not people who are billionaires.

2.D.1. Exercises: Translate from Ordinary Language to Categorical Form:

1. Michael Bloomberg was mayor of New York City, NY for over three years.

2. None of the buses were on time this morning.

3. Few youths have any purpose today.

4. Most of my clothes don't fit.

5. All carry-outs sell expensive food.

6. Some movie stars ain't got much intelligence.

7. Most athletes have strong bodies.

8. Without Koca-kola, no party is complete.

9. Nobody loves me.

10. Every lover knows what happiness is.

11. Few birds wear colored glasses.

12. Not many people swim well.

13. Ain't no child supposed to tell me what to do.

14. A few of my friends own sports cars.

15. Most of the problems in today's economy derive from our involvement in the Iraqi War.

16. Every Sunday the preacher comes to our house for dinner.

17. Only a miracle could have saved me.

18. Everything I did was for her.

19. Most residents of the city don't run for mayor.

20. Washington, D.C. is south of New York.

2.D.2. Exercises: For each statement below, circle the letter of the best translation into categorical form:

1. Every horse has a liver.

- a. Most horses have livers.
- b. Some animals that are horses are animals that have livers.
- c. All animals that are horses are animals that have livers.
- d. All animals that have livers are animals that are horses.
- e. All animals are horses that have a liver.

2. Many arrows hit the target.

- a. No object that hit the target is an object that is an arrow.
- b. All objects that hit the target are objects that are arrows.
- c. Some objects that are arrows are objects that hit the target.
- d. Some objects that are not arrows are objects that did not hit the target.
- e. Some objects that are arrows are not objects that hit the target.

3. A few men are honest.

- a. Some people who are men are not people who are honest.
- b. Many people who are men are people who are honest.
- c. Most people who are men are people who are honest.
- d. Not many people who are men are people who are honest.
- e. Some people who are men are people who are honest.

4. Few men who are ambitious are trustworthy.
 - a. Some men who are ambitious are men who are trustworthy.
 - b. Some men who are not ambitious are men who are trustworthy.
 - c. Some men who are not ambitious are men who are not trustworthy.
 - d. Some men who are trustworthy are men who are ambitious.
 - e. Some men who are ambitious are not men who are trustworthy.

5. Only students who take their tests will pass this course.
 - a. All students who take their tests are students who will pass this course.
 - b. Some students who take their tests are students who will pass this course.
 - c. Some students who will pass this course are students who take their tests.
 - d. All students who pass this course are students who take their tests.
 - e. All students who take their tests are not students who will pass this course.

6. Jane Brown will make the team.
 - a. All persons who are Jane Brown are persons who will make the team.
 - b. Some person who is Jane Brown is a person who will make the team.
 - c. Some person who will make the team is a person who is Jane Brown.
 - e. No person who will not make the team is a person who is not Jane Brown.

CHAPTER 3:

CATEGORICAL INFERENCE

Inference is the process by which the truth of one proposition (the conclusion) is affirmed on the basis of the truth of one or more other propositions that serve as its premise or premises. When a conclusion is drawn from only one premise, the inference is said to be immediate. Where there is more than one premise involved, the inference is said to be mediate. This chapter will study these two forms of argument in categorical logic.

A. Arguments Expressing Immediate Inference

We will consider three kinds of immediate inferences:

1. Immediate inferences embodied in the square of opposition
2. Obversion
3. Conversion

I. Introduction to the **Traditional Square of Opposition.**

In everyday life, we come across many complex issues. People express their opinions about them in statements or propositions. Let us take the issue of war, for example. Some are opposed to all forms of violence. And they express their position on war by defending the proposition that “All wars are unjust.” This is a pacifist position. On the other hand, others might associate themselves more closely with Social Darwinism, believing that evolution is through survival of the fittest and that “No war is unjust.” However, someone who attempted to defend both propositions would be inconsistent: “All wars are unjust and “no wars are unjust” cannot both be true.

Now suppose Alicia asserts that “Some wars are unjust.” Should we take this to imply that she believes “Some wars are not unjust”? Does the truth of “Some men are fathers”

imply that “Some men are not fathers” is also true? It is a common fallacy to assume that the truth of a statement of the form “Some S are P” necessarily implies the truth of the statement with form “Some S are not P.” Thus, many find it difficult to accept the truth of “Some fathers are men” because they misleadingly believe this would imply that they accept “Some fathers are not men” as true.

Debates in morality, science, politics, and other areas underscore the importance of knowing what can be validly inferred from the assertion of a given proposition. Civil debates are the way we exchange ideas and persuade others. They emphasize the importance of knowing how to present, defend, and reject contentious claims. The traditional square of opposition is an important tool in understanding the logical relationships between categorical propositions with the same subject and predicate.

II. The Four Kinds of Opposition

There are four kinds of categorical propositions, first introduced in Chapter Two: A, E, I, and O.

A: All S are P	Universal Affirmative
E: No S are P (All S are not P)	Universal Negative
I: Some S are P	Particular Affirmative
O: Some S are not P	Particular Negative

Each of these propositions can serve as a premise for immediate inference. Thus, if an A proposition is used as a premise, then one can immediately infer that the corresponding O proposition (having the same subject and predicate terms as the A) is false. To illustrate, if the A proposition: “All car salesmen are liars” is given as true, then the O proposition: “Some car salesmen are not liars” must be false.

The traditional square of opposition provides a basis for this kind of immediate inference. The term “opposition” was used by classical logicians to apply to the differences in

quality (affirmative or negative) and quantity (universal or particular) between standard-form categorical propositions having the same subject and predicate terms.

There are four kinds of opposition:

1. Contrary Opposition is opposition between two universals of different quality (A and E).
2. Contradictory Opposition is that between a universal and a particular of different quality (A and O; E and I).
3. Subcontrary Opposition is opposition between two particulars of different quality (I and O).
4. Subaltern opposition is that between a universal and a particular of the same quality (A and I; E and O).

These various kinds of opposition can best be illustrated by a diagram called the Square of Opposition as shown below:

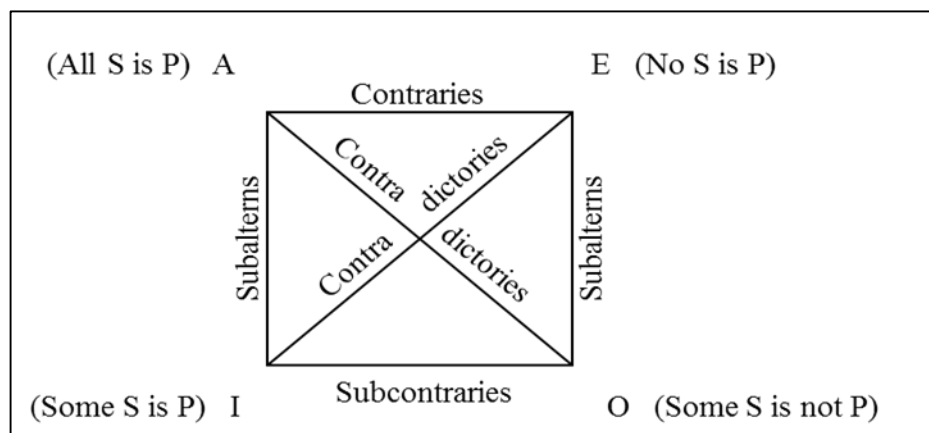

Figure 3.1

III. Rules of Opposition

We can derive rules of immediate inference for each of the four types of opposition mentioned above. These inferences will be from a premise to a conclusion. The premise will be indicated by enclosing its truth-value in a small box within the square as shown:

Example: In the diagram, the A proposition is the premise. We read it as: “Given the A as true, therefore, the O is. . .”

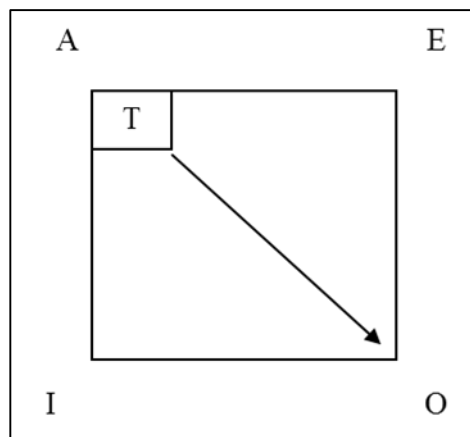

Figure 3.2

Deriving the Rules of Inference for Contradictory Opposition

Contradictory Opposition is that between the A and the O, and the E and the I proposition. Let us consider the A and the O first.

If the statement, “All coins in my pocket are quarters” (A proposition), is true, what can be inferred about the opposed statement, "Some coins in my pocket are not quarters" (O proposition)? True or False? It requires little reflection to see that *if* the A is true, then the O cannot also be true. And it is equally as easy to see that *if* the O is true (Some coins in my pocket are not quarters), then the A must be false (All coins in my pocket are quarters).

We can summarize our analysis in a table as follows:

<u>Premise</u>	<u>Conclusion</u>
Given A as true,	therefore O is false.
Given O as true,	therefore A is false.

Using the square, we can illustrate the inference thus:

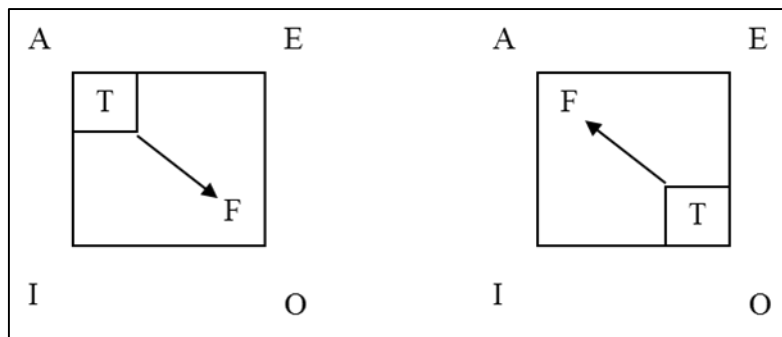

Figure 3.3

The truth-value in the small box shows the truth-value of the premise, and the truth-value outside the box is the truth-value of the possible conclusions. The arrow shows the direction of the inference.

Let us next consider the E and I Contradictories:

E: No coins in my pocket are quarters.

I: Some coins in my pocket are quarters.

Again, it is easy to see that if the E is given as true, the I cannot also be true, and if the I is given as true, the E cannot also be true.

Using the Square, we can illustrate this in the following manner:

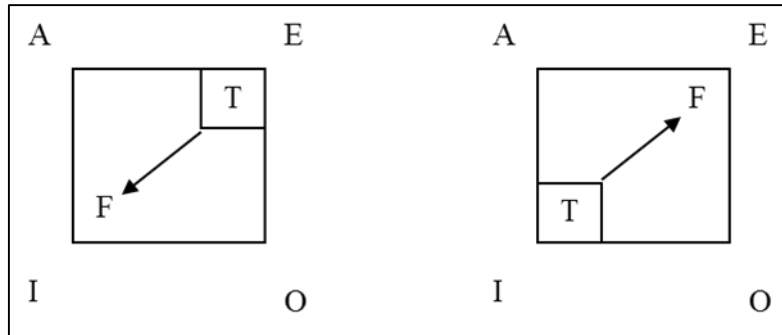

Figure 3.4

Combining the A and O and E and I inferences into a table we have:

<u>Premise</u>	<u>Conclusion</u>
Given A as true,	therefore O is false
Given E as true,	therefore I is false
Given I as true,	therefore E is false
Given O as true,	therefore A is false

Observe from the table that the premise and the conclusion cannot both be true at the same time. From this observation, we can now formulate the first rule for contradictory opposition as follows:

Rule 1: CONTRADICTORY PROPOSITIONS CANNOT BOTH BE TRUE.

So far, we have been considering the premises to be true. Suppose now that the premises were given as false, then what conclusion can we infer? If A is false, what is O? If O is false, what is A? If E is false, what is I? And if I is false, what is E? Again, let us consider our example above to see what inference we can make.

If the A proposition “All coins in my pocket are quarters” is false, then, what can we infer about the corresponding O proposition “Some coins in my pocket are not quarters”? Clearly, we can infer that the O must be true. And if the O is given as false, it is easy to see that the A must necessarily be true.

Let us next consider the E Proposition “No coins in my pocket are quarters” to be false. Then, what can we infer about the I Proposition “Some coins in my pocket are quarters”? Clearly, if the E is false, then the I must be true.

We can sum up the result of the above analysis in the following table:

Premises	Conclusion
Given A as false,	therefore O is true.
Given E as false,	therefore I is true.
Given I as false,	therefore E is true.
Given O as false,	therefore A is true.

Observe from the table that the premise and the conclusion cannot both be false at the same time. From this we can now formulate the second rule for contradictory opposition as follows.

Rule 2: CONTRADICTORY PROPOSITIONS CANNOT BOTH BE FALSE.

The rule can be summarized in terms of the Square as follows:

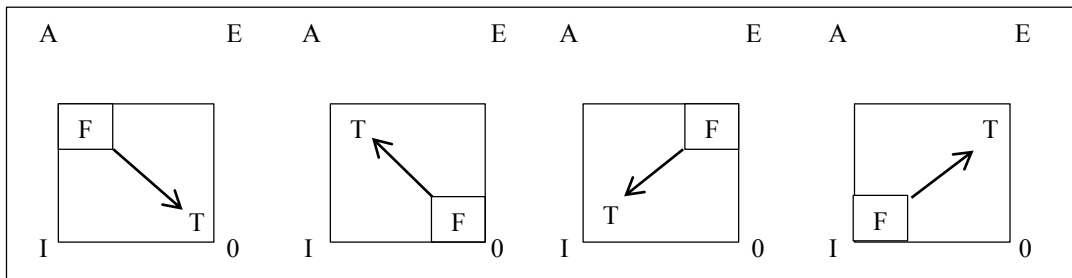

Figure 3.5

Deriving the Rules of Inference for Contrary Opposition

Contrary Opposition is the opposition between the A and the E. Now, if A is given as true, what is E? And if the E is given as true, what is A?

Again, let us use the concrete example given above. Thus, if the A (All coins in my pocket are quarters) is true, then what can be inferred about E (No coins in my pocket are quarters)? Well, if it is true that “All coins in my pocket are quarters,” then it is necessarily false that none are quarters. Similarly, if it is true that “No coins in my pocket are quarters,” then it is necessarily false to say that “All coins in my pocket are quarters.”

We can summarize the inferences in following table:

Premise	Conclusion
Given A as true,	therefore E is false.
Given E as true,	therefore A is false.

Observe in the table that the premise and the conclusion cannot both be true at the same time. We can thus formulate our first rule as follows:

Rule 1: CONTRARY PROPOSITIONS CANNOT BOTH BE TRUE.

Using the Square to illustrate the rule, we have:

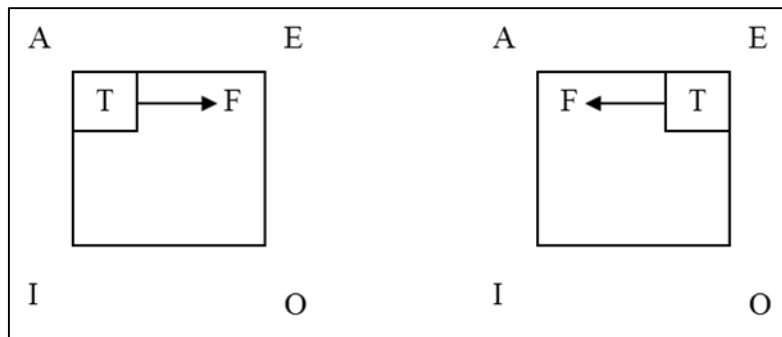

Figure 3.6

Let us now consider the premises to be given as false. Thus, if A is given as false, what can we infer about E? And if E is false, what can we infer about A? To help us in our analysis, let us again use the example above.

Consider the A statement “All coins in my pocket are quarters” to be false.

Does it follow that none of the coins in my pocket are quarters (E)? No, we cannot necessarily infer this to be true, because it could also be the case that only some coins are quarters (I) while the rest are not (O).

Thus, the statement, “All coins in my pocket are quarters” is false if either (1) “No coins in my pocket are quarters” (E) is true, or 2) “Some coins in my pocket are not quarters (O) is true. If we know that an A proposition is false we can conclude that the corresponding O proposition must be true. But we cannot conclude that the corresponding E proposition must be true. All we can conclude is that it is possible for E to be true, but it is also possible for E to be false. Indeed, A and E could both be false.

Our analysis above also holds also if E is false. We cannot use this to infer that A must be true. All we can conclude is that it is possible for A to be true, but it is also possible for it to be false. Thus, E and A could both be false. To see this, consider that the E statement, “No coins in my pocket are quarters” is false if 1) All coins in my pocket are quarters is true (A), or 2) Some coins in my pocket are not quarters is true (O). Since we cannot determine by logic alone which condition is the case, the truth of A is undetermined by the falsity of E.

We can summarize our analysis in a table as follows:

Premise	Conclusion
Given A as false,	therefore E is undetermined (could be false or true).
Given E as false,	therefore A is undetermined (could be false or true).

Rule 2: CONTRARY PROPOSITIONS CAN BOTH BE FALSE.

Using the Square to illustrate the rule we have:

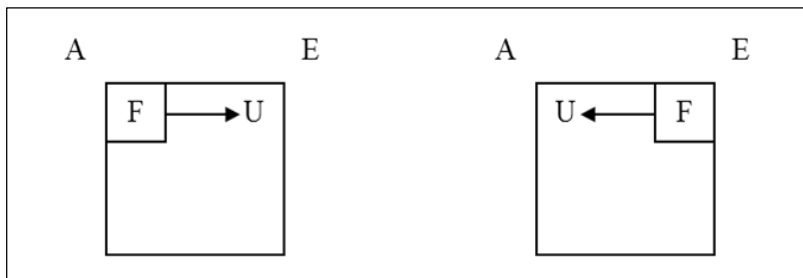

Figure 3.7

Deriving the Rules of Inference for Subcontrary Opposition

Subcontrary Opposition is opposition between the I and the O propositions. Let us see what we can infer if the premises are taken as true. Consider the following example: Suppose we assume that the I proposition “Some planets are things that have moisture” (I) is true. What can we infer about the truth or falsity of the O proposition “Some planets are not things that have moisture”? Can we infer the O to be true? No, because further exploration might prove that all planets have moisture (A). If this is the case, then the O proposition would not be true.

Can we infer then that the O proposition is false? We cannot infer this either since further exploration might prove that, in fact, some planets are actually dry, in which case the O proposition would be true.

If the I proposition is given as true, the O proposition could be false or could be true. We cannot determine which is the case by logical inference alone.

It is similar in cases where the O is assumed true. Thus, if the statement, “Some planets are not dry places” is true (O), we cannot infer that the statement "Some planets are dry places" is true (I). For future investigation, might prove that “No planets are dry places” (E) is true, in which case, the I proposition would necessarily be false. Thus, if the O is given as true, the truth-value of the corresponding I proposition is undetermined. That is, it could be true or it could be false.

Summarizing the result of our analysis, we have:

<u>Premise</u>	<u>Conclusion</u>
Given I as true,	therefore O is undetermined.
Given O as true,	therefore I is undetermined.

Observe that because the conclusion is undetermined, it is possible for both subcontraries to be true at the same time. Thus, given the I as true, the O can be true, and given the O as true, the I can be true. From this observation, we can formulate the first rule as follows:

Rule 3: SUBCONTRARY PROPOSITIONS CAN BOTH BE TRUE.

The square of opposition can be used to illustrate the rule as follows:

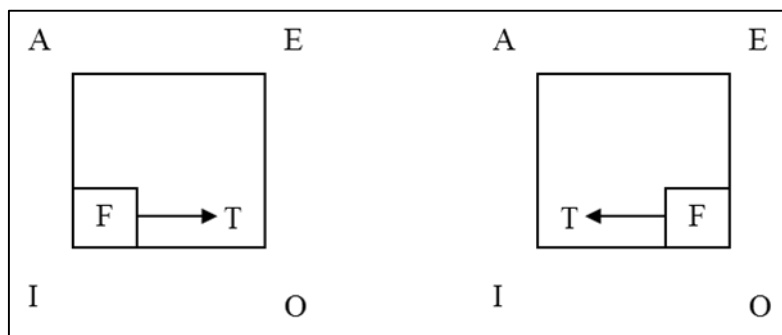

Figure 3.8

It might be worth repeating here that contrary to common belief, we cannot infer the truth of one subcontrary from another. For example, from the truth of the statement, “Some people are rich,” we cannot infer the truth of its subcontrary, namely, “Some people are not rich.” This latter statement is true, not as an inference from the truth of the subcontrary I proposition but from an independent source of knowledge, namely, our knowledge that there are, in fact, some people who are not rich. Likewise, given the truth of the statement “Some marbles in my pocket are red” it does not necessarily follow that “Some marbles in my pocket are not red.”

Now consider the case where the premises are assumed to be false. If the statement, “Some coins in my pocket are quarters” is false, what can we infer about the statement, “Some coins in my pocket are not quarters”? If it is false that some coins in my pocket are quarters, then it follows necessarily that no coins in my pocket are quarters. If it is true to say that no coins in my pocket are quarters, it is also necessarily true that some coins in my pocket are not quarters. So, if I is given as false, then O is necessarily true.

What if an O proposition is assumed false? For example, suppose “Some coins in my pocket are not quarters” is false. Then, it follows necessarily that all the coins in my pocket are quarters. If it is true that all of the coins in my pocket are quarters, it follows that some of the coins in my pocket are quarters must be true. Thus, if O is given as false, then I is necessarily true. Summarizing the inferences in a table, we have:

<u>Premise</u>	<u>Conclusion</u>
Given I as false,	therefore O is true.
Given O as false,	therefore I is true.

From this we can formulate the second rule as follows:

Rule 4: SUBCONTRARY PROPOSITIONS CANNOT BOTH BE FALSE.

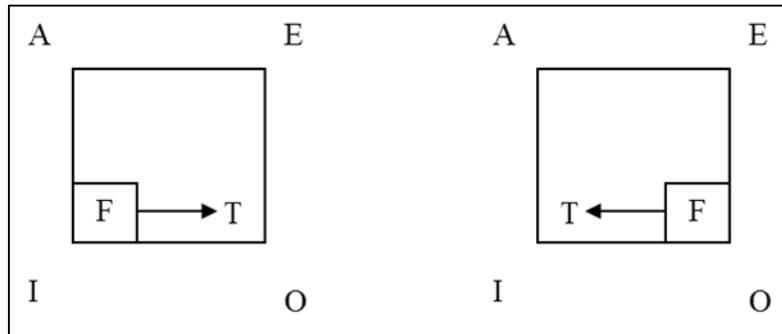

Figure 3.9

Deriving the Rules of Inference for Subaltern Opposition

Subaltern Opposition is opposition between the A and the I and between the E and the O propositions. If A is given as true, what can we infer about the corresponding I proposition? And if E is assumed true, what can we infer about the truth of the corresponding O?

Assuming the statement “All coins in my pocket are quarters” to be true, we can infer that “Some coins in my pocket are quarters” must be true. Similarly, if “No coins in my pocket are quarters” is true, then it must be true that “Some coins in my pocket are not quarters.”

Next, take the I and the O as premises. Thus, if I is assumed true, what can we infer about the truth or falsity of the corresponding A proposition? And if the O is assumed true, what can we infer about the truth-value of the corresponding E proposition?

We can summarize our inferences in a table as follows:

<u>Premise</u>	<u>Conclusion</u>
Given A as true,	therefore I is true.
Given E as true,	therefore O is true.

Using the square to illustrate the inferences, we have:

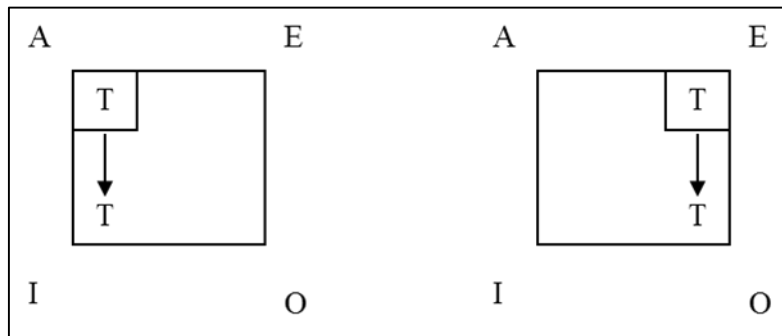

Figure 3.10

Assume now that the I and the O propositions are true. If the statement, “Some planets are things that have moisture” is true, can we infer that the A statement, “All planets are things that have moisture” is also true? Certainly not, since it remains possible that some planets do not have moisture. But can we infer that the A proposition is false? We cannot infer this either since it is also possible that further investigation may, in fact, prove that all planets are moist places. Thus, if the I is true, then the truth-value of the A proposition is undetermined.

Similarly, from the truth of the statement, “Some planets are not dry,” we cannot infer that “No planets are dry” is true. The truth of the O proposition leaves the truth of the E proposition undetermined. We can summarize our analysis in the following manner:

<u>Premise</u>	<u>Conclusion</u>
Given I as true,	therefore A is undetermined.
Given O as true,	therefore E is undetermined.

Using the Square to illustrate these inferential relationships, we have:

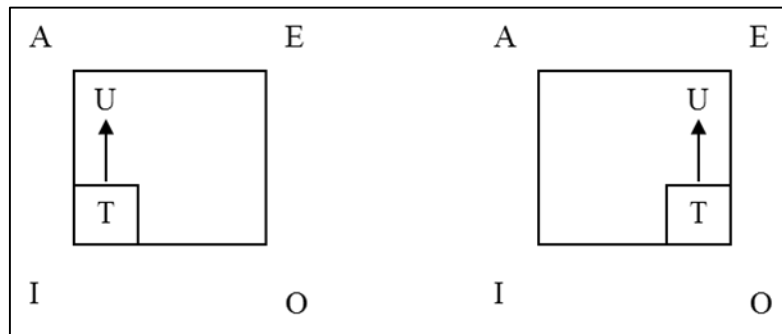

Figure 3.11

Rule 1 summarizes the cases in which the premises are taken as true:

Rule 1: GIVEN THE UNIVERSAL AS TRUE, ITS PARTICULAR MUST BE TRUE.

GIVEN THE PARTICULAR AS TRUE, ITS UNIVERSAL IS UNDETERMINED.

Note: The first part of the rule makes the existential assumption. See part B of this chapter where this is discussed.

Let us now examine cases where the premises are assumed to be false. First, assume the A statement, “All coins in my pocket are quarters” to be false. As we analyzed earlier under contrary opposition, if the statement is false, then one of the two following statements is true: 1) No coins in my pocket are quarters (E), or 2) Some coins in my pocket are not quarters (I). Since we cannot logically infer which of the two conditions is the case, all we can conclude is that if the A is false, then the truth or falsity of the E and I is undetermined.

Our analysis also holds true if the E is given as false. Thus, if “No coins in my pocket are quarters” is false, then, either “All coins in my pocket are quarters” (A) is true or “Some coins in my pocket are quarters” (O) is true. Since we cannot infer whether the A is true given that the E is false, we cannot infer the truth-value of the O. The truth value of O is undetermined by the falsity of E: O could be true or O could be false.

Summarizing our analysis in a table we have:

<u>Premise</u>	<u>Conclusion</u>
Given A as false,	therefore I is undetermined.
Given E as false,	therefore O is undetermined.

Using the Square to illustrate the inferences, we have:

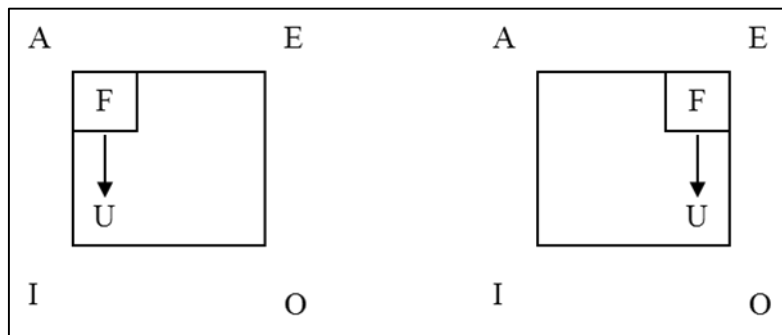

Figure 3.12

Secondly, let us assume that the premises I and O are false. If the I statement, “Some coins in my pocket are quarters” is false, then what is the truth-value of the A statement “All coins in my pocket are quarters”? It must be false. I cannot hold that “All coins in my pocket are quarters” is true if we have assumed that “Some coins in my pocket are quarters” is false. Likewise, if the O is assumed false, the E is necessarily false.

We can summarize our analysis in a table as follows:

Premise	Conclusion
Given I as false,	therefore A is false.
Given O as false,	therefore E is false

Using the Square to illustrate the table we have:

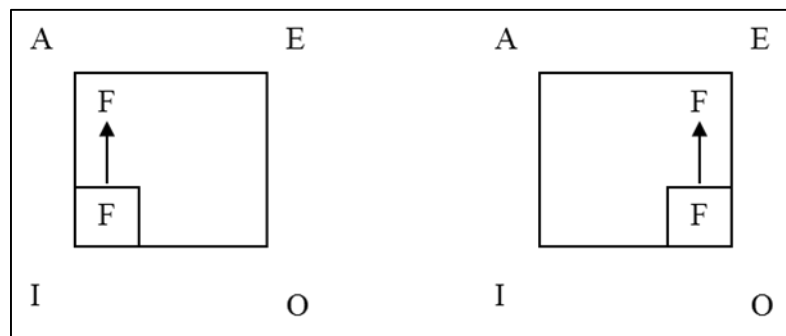

Figure 3.13

We can now formulate the second rule for subaltern opposition.

Rule 2: GIVEN THE UNIVERSAL AS FALSE, ITS PARTICULAR MUST BE UNDETERMINED.

GIVEN THE PARTICULAR AS FALSE, ITS UNIVERSAL MUST BE FALSE.

There are two methods of outlining inferences from the Square of Opposition, and a summary of both appear on the next page. First, there is the table, which is read across from the premise to the various conclusions that can be inferred from the one premise.

The second outline is by means of squares. Observe that the arrows point to the logical inferences that can be made from a given premise. For example, from A as true, I can infer E as false and I as true. Or, having inferred I as true, I can then use it as a premise to infer E as false (rule of contradiction).

Square of Opposition Table

Premise	Conclusions			
	A	E	I	O
A true, therefore	True	False	True	False
E true, therefore	False	True	False	True
I true, therefore	Undetermined	False	True	Undetermined
O true, therefore	False	Undetermined	Undetermined	True
A false, therefore	False	Undetermined	Undetermined	True
E false, therefore	Undetermined	False	True	Undetermined
I false, therefore	False	True	False	True
O false, therefore	True	False	True	False

Figure 3.14

We can also summarize the rules graphically by using the square:

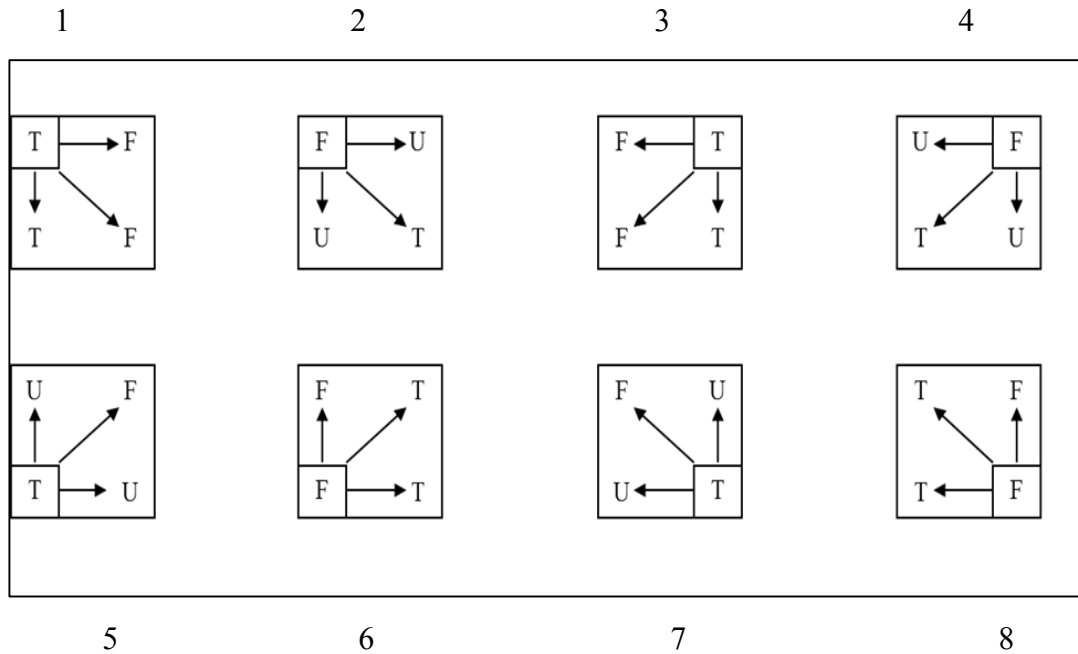

Figure 3.15

Practical Application of the Square of the Opposition.

One useful application of the table of opposition is the clear indication of how to refute a proposition. In debates and discussions, propositions with regard to certain issues are often assumed, for example, “All handguns should be banned,” “No abortions should be funded,” “All wars are unjust,” “All forms of free-enterprise benefit the poor” and so on. The rules of opposition show that the only propositions that cannot both be true are contraries and contradictories. It follows that the only way to refute any proposition is to establish the truth of either its contrary or its contradictory. Let us summarize this in the following table:

<u>Proposition</u>	<u>Refuted by the Truth of</u>	<u>Squares</u>
A	E or O	3, 7, 6
E	A or I	1, 5, 8
I	E	3
O	A	1

1. Observe that the I proposition cannot be refuted by an O or the O by the I. The reason is that both subcontrary propositions could be true. Thus, “Some horses are colts,” and “Some horses are not colts,” are both true.

2. Observe that though the A proposition can be refuted by the E and the E by the A, there is the possibility that we may be refuting one false proposition by another. The reason is that both contrary propositions could be false. We cannot infer that if A is false, E is necessarily true. Thus, in trying to refute an A by an E, which is certainly possible, one must be sure of all of the facts. If you decide to refute the Freudian claim that “All forms of religion are infantile” (A), by giving its contrary, “No forms of religion are infantile,” you must be sure that every instance of religion is not infantile— a very difficult, if not impossible claim to establish. This leads us to the next observation.

3. An easier and more practical method of disproving an A or E is to establish its contradictory. All you need do here is to give one instance which would contradict the A or E.

At this point, one might ask if we cannot equally refute an A by showing its subalternant I to be false. If it can be shown that I is false, it follows that the A proposition is false. But this procedure is really the same as establishing the contrary to be true. In other words, to prove that the I is false, you have to show that the E is true.

4. In an argument or debate, it is wise to avoid making universal statements (A or E) unless you are reasonably sure of all instances. Otherwise all your opponent has to do to refute you is to give one contradictory instance.

5. Hedge your statements by phrases such as, “For the most part,” “In general...”, and “In most cases...”. The resulting statements are either I or O propositions and are difficult to refute because this would require proving that the A or E universal propositions must be true.

3.A.1. Exercises: Square of Opposition:

Answer the following:

1. Illustrate each of the four types of opposition.
2. How does one refute an A proposition?
3. How does one refute an E proposition?
4. How does one refute an I proposition?
5. How does one refute an O proposition?

3.A.2. Exercises: Decide whether the following inferences are valid or invalid:

1. Given A as false, therefore E is true. _____
2. Given E as true, therefore O is false. _____
3. Given I as true, therefore O is true. _____
4. Given O as false, therefore I is true. _____
5. Given A as true, therefore I is undetermined. _____
6. Given E as false, therefore I is undetermined. _____
7. Given I as false, therefore O is undetermined. _____
8. Given O as true, therefore I is undetermined. _____
9. Given E as false, therefore A could be false. _____
10. Given I as true, therefore O could be true. _____
11. Given All X are Y as false, therefore No X are Y is true. _____
12. Given No A are B as true, therefore All A are B is false. _____
13. Given Some A are B as true, therefore No A are B is false. _____
14. Given Some C are not D as false, therefore Some C are D is true. _____
15. Given All S are P as true, therefore Some S are P is true. _____
16. Given No S are P as false, therefore Some S are not P is false. _____
17. Given Some S are P as false, therefore Some S are not P is true. _____
18. Given No L are M as true, therefore Some L are not M is true. _____
19. Given All L are M as true, therefore Some L are M is true. _____
20. Given Some L are M as true, therefore All L are M is true. _____

3.A.3. Exercises: In each of the following sets of statements, if the first statement (premise) is assumed to be true (T), indicate what can be inferred using the square of the opposition as the truth-value (True, False or Undetermined) of the subsequent statements. Then assume the first statement to be false and do the same.

a. All good deeds are deserving of praise.	T	F
No good deeds are deserving of praise.	_____	_____
Some good deeds are deserving of praise.	_____	_____
Some good deeds are not deserving of praise.	_____	_____
b. No tyrants are just persons.	T	F
All tyrants are just persons.	_____	_____
Some tyrants are just persons.	_____	_____
Some tyrants are not just persons.	_____	_____
c. Some people are benefactors of humankind.	T	F
All people are benefactors of humankind.	_____	_____
No people are benefactors of humankind.	_____	_____
Some people are not benefactors of humankind.	_____	_____
d. Some persons are not believers in God.	T	F
All persons are believers in God.	_____	_____
No persons are believers in God.	_____	_____
Some persons are believers in God.	_____	_____

3.A.4. Exercises: Determine whether the following immediate inferences are valid or invalid.

- | | |
|--------------------|------------------------------------|
| 1. Given as false: | Some students are not nice people. |
| therefore true: | Some students are nice people. |
- | | |
|-------------------------|-----------------------------------|
| 2. Given as true: | All communists are radicals. |
| therefore undetermined: | Some communists are not radicals. |
- | | |
|-------------------------|--|
| 3. Given as true: | Some acts of violence are not justifiable. |
| therefore undetermined: | Some acts of violence are justifiable. |
- | | |
|-------------------------|---|
| 4. Given as false: | No believer is an unhappy person. |
| therefore undetermined: | Some believers are not unhappy persons. |
- | | |
|-------------------|-------------------------------------|
| 5. Given as true: | No poor people are happy persons. |
| therefore false: | Some poor people are happy persons. |
- | | |
|-------------------|------------------------|
| 6. Given as true: | All dogs are animals. |
| therefore true: | Some dogs are animals. |
- | | |
|--------------------|---------------------------|
| 7. Given as false: | Some planes are jets. |
| therefore true: | Some planes are not jets. |

8. Given as true:

No hero is a coward.

therefore false:

All heroes are cowards.

3.A.5. Exercises: What proposition must be shown to be true in order to refute the following statements:

1. All motorcars are polluters.

2. No Hispanic person is a rich capitalist.

3. All women are poor drivers.

4. Some private enterprises are not enemies of the poor.

5. Some homes for sale are expensive.

6. All Republicans are conservative individuals.

7. Some politicians are corrupt officials.

8. Some auto mechanics are not dishonest persons.

9. All fetuses in the womb are human beings.

10. Some nations are not colonizers.

11. All SUV drivers are rude people.

12. Some swans are black.

13. No atheist is a moral person.

14. No philosopher is a mathematician.

15. All Europeans are anti-Semitic.

3B. Set Theoretic Concepts: Complementation, Venn Diagrams, and Distribution

In Aristotelian logic each statement in ordinary language that is true or false is interpreted as representing a certain relationship between two classes of things - the class of things referred to by the subject of the statement and the class of things referred to by the predicate of the statement. Statements are re-written into standard categorical form in order to make clear what the subject and predicate terms are and exactly what relationship is being asserted between them. We have seen that this involves clearly specifying the subject class S , the predicate class P , the quantity of the subject intended (universal or particular) and the copula (affirmative or negative).

This information can be represented using Venn diagrams. This is done by first drawing two interlocking circles, the first circle representing the subject class (S) and the second circle representing the predicate class (P):

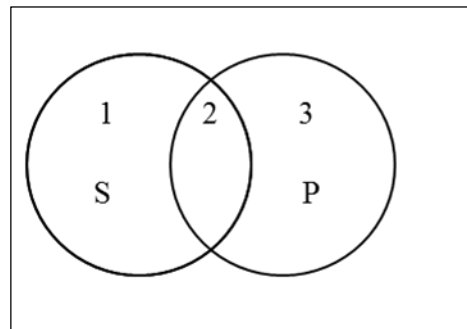

Figure 3.16

The two interlocking circles have three sections, section 1, section 2, and section 3. Section 1 is that part of S that does not contain any of P . Section 2 is that part of S that is also a part of P . And section 3 is that part of P that does not contain any of S . The notion of the complement of a set is useful here: For any class, K , there is another class called the **complement of K** (symbolized as $\text{non-}K$ or K^*), which consists of all the things in the universe that are not members of K .

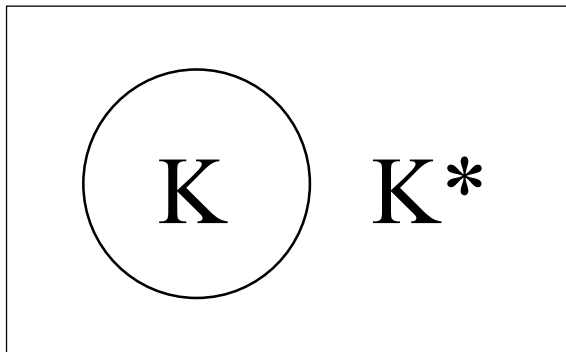

Figure 3.17

Thus, if D is the class of dogs then D* would refer to the class of all things which are non-dogs.

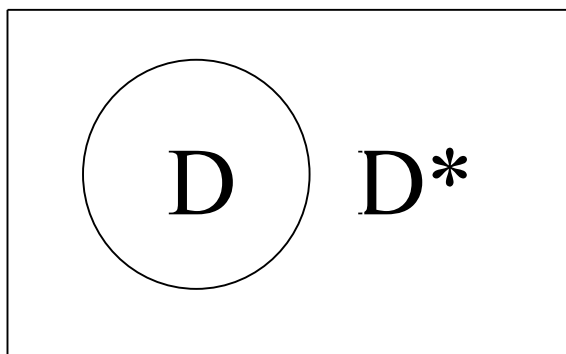

Figure 3.18

We can now describe sections 1, 2, 3 as follows:

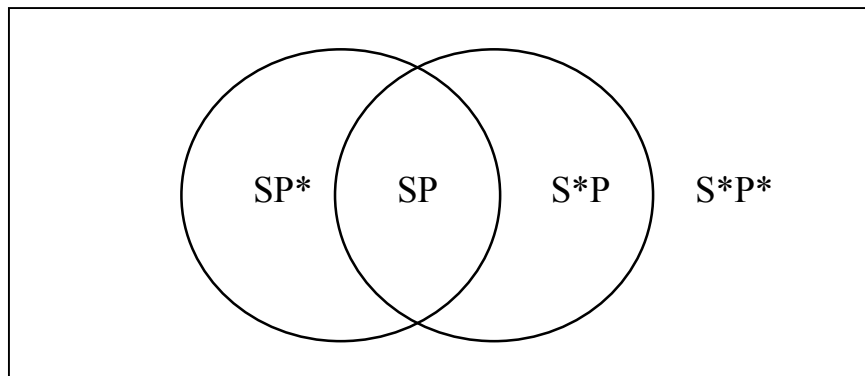

Figure 3.19

All S^*P^* is that part of the universe that contains no members of S and no members of P.

SP^* is that part of the universe that contains members of S and no members of P.

S^*P is that part of the universe that only contains members of P and no members of S.

SP is that part of the universe whose elements are simultaneously members of S and members of P.

Using these conventions, we can now represent all the propositional forms of categorical logic in Venn diagram form.

Any statement of the form "All S are P" is asserting that, if there are any members of S, they cannot be in that part of the universe designated SP^* . Rather, they must be in that part of the universe designated by SP . We adopt the convention of shading in a portion of the universe to indicate that nothing is in that portion.

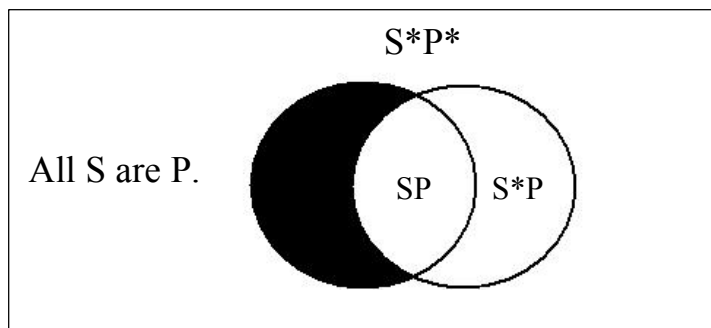

Figure 3.20

Any statement of the form "No S are P" is asserting that there are no members of S that are also members of P. This means that there are no members of SP . SP is empty and we symbolize this as:

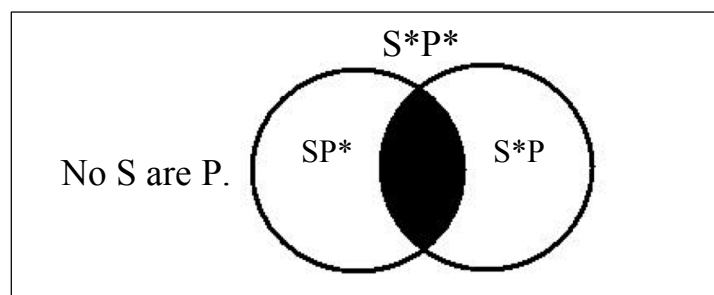

Figure 3.21

In order to symbolize the kind of relationship that holds in particular propositions, we adopt a second convention, that of putting an X in that portion of the universe in which a proposition asserts that something exists. Thus, any statement of the form “Some S are P” is asserting that there is something that is a member both of S and of P. This is symbolized as:

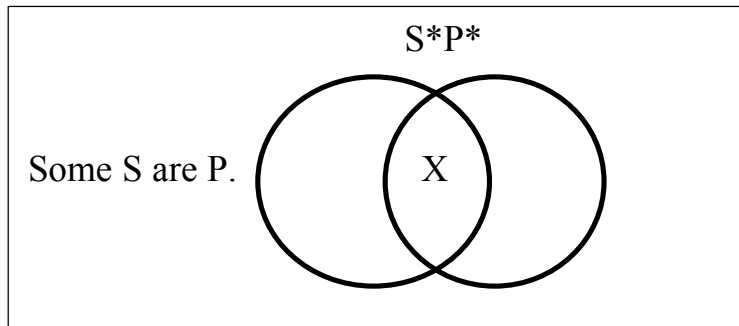

Figure 3.22

Finally, any statement that has the categorical form of “Some S are not P” is asserting that there exists something in S that is not a member of P. This is symbolized as:

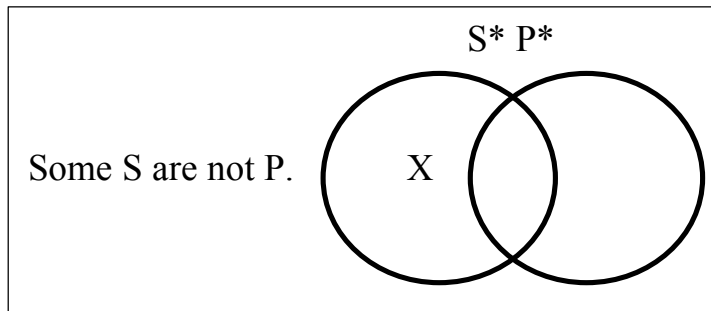

Figure 3.23

This information is summarized as follows:

Propositional Form

Venn Diagram Form

A: All S are P

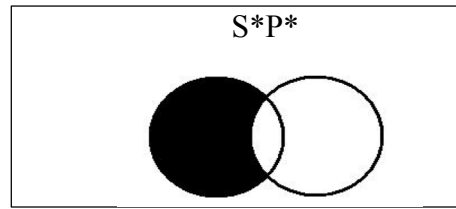

E: No S are P

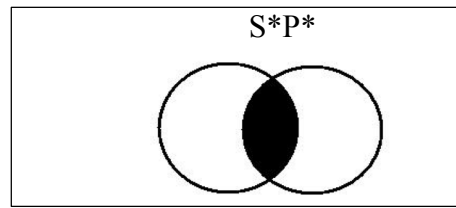

I: Some S are P

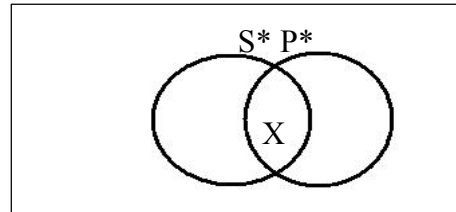

O: Some S are not P

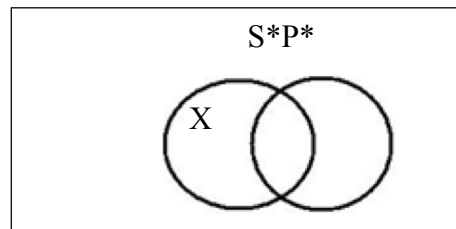

We classify statements as having a universal or particular propositional form depending on the quantity of the subject class intended. Thus, statements having an A or E form are called universal propositions because they relate every member of the subject class to the predicate class; in an A proposition, every member of the subject is included in the predicate class, while in an E proposition every member of the subject class is excluded from the predicate class.

Likewise, statements having an I or O propositional form are called particular propositions because they relate only some of the members of that subject class to the predicate class: in an I proposition, part of S is included in part of P; while in an O proposition part of S is excluded from all of P.

While we will continue to classify the form of a statement as universal or particular based on the quantity of the subject class intended, we can nonetheless talk about the quantity of the predicate class that is being related to the subject class. Thus, in an A proposition (“All S are P”), while we are saying something about every member of S, we are not saying something about every member of P. While it is true that all dogs are animals (“All D are A”), it is false that all animals are dogs (“All A are D”), rather, only some animals are dogs (“Some A are D”). In general, if all members of S are included in the class of Ps, we can only conclude from this that some of P is S. Thus, in an A proposition, the quantity of the subject is universal and the quantity of the predicate is particular.

In a statement having an E propositional form (“No S are P”), we are excluding all members of S from being members of P. And we are excluding all members of P from being members of S. In this case, the subject class is universal and the predicate class is universal. Thus, if “No cats are dogs” is true, then “No dogs are cats” is equally true.

In a statement having an I propositional form (“Some S are P”), part of the subject class is included in the predicate class and part of the predicate class is included in the subject class. Thus, both the subject and the predicate class are particular. Finally, in a statement having an O propositional form (“Some S are not P”) part of the subject class is being excluded from all of the predicate class. The O proposition says something about every member of the predicate class, namely that there is at least one member of the subject class that is distinct from every member of the predicate class. Thus, the quantity of the subject class is particular and the quantity of the predicate class is universal.

The following table summarizes the quantity of the subject and predicate terms for each of the propositional forms of Aristotelian logic:

- A: All S (universal) are P (particular)
- E: No S (universal) are P (universal)
- I: Some S (particular) are P (particular)
- O: Some S (particular) are not P (universal)

A term is **distributed** in a proposition if its quantity in that proposition is universal. A term is **undistributed** in a proposition if its quantity in that proposition is particular. The following table tells us, for each of the A, E, I, and O propositional whether its subject (S) or its predicate (P) is distributed or undistributed.

	Distributed	Undistributed
A	S	P
E	S, P	
I		S, P
O	P	S

3.B.1. Exercises:

Give the Venn Diagram representation of each of the following propositions and indicate whether the subject and predicate are distributed (D) or undistributed (Und.).

1. No elephant is beautiful.

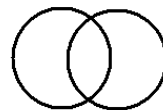

2. Some candies are fattening.

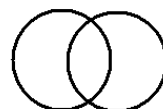

3. All candies are fattening.

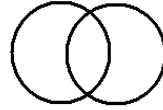

4. Some books are not enlightening.

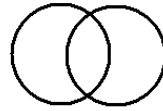

5. No incubators are cold.

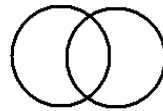

6. Some important news is depressing.

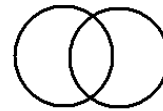

7. All elevators are round.

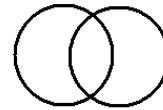

8. Some independent farmers are not bankrupt.

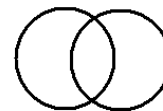

9. All rugs are hand-woven.

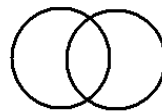

10. Some dogs are animals that are not large.

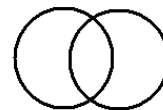

Obversion and Conversion

Two kinds of immediate inferences often occur in everyday life. They are formally called obversion and conversion.

To illustrate, take the following situation: A, B and C are discussing the economic situation. A complains to B: "Many poor people are unemployed." C, who is hard of hearing, asks B to repeat what A said. So, B tells C that A said "Many poor people are not employed." But A immediately objects and tells B that that is not what A had said. A then repeats the original statement "Many poor people are unemployed." B insists that this says the same thing. Who is right, A or B?

Take another example where A is arguing with B.

A: "I maintain that all communists are radicals."

B: "I don't agree. I don't believe that all radicals are communists."

A: "But I didn't say that."

B: "Well, it's the same thing."

Is B correct in her contention that "All communists are radicals" means the same thing as "All radicals are communists"?

The first example illustrates the immediate inference called obversion. The second illustrates the immediate inference called conversion.

C. OBVERSION

Obversion is the process of constructing an equivalent statement from a premise in such a way that the quantity and subject of the premise remains the same while the quality and the predicate are changed to their opposites.

Premise: All voters are citizens.
 All people who are voters are people who are citizens.

Obverse: No voters are non- citizens.
 No people who are voters are people who are not citizens.

In the obverse, the quantity of the original statement remains universal and the subject is voters, but the quality and predicate has changed. In the original statement, the quality of the proposition was affirmative. In the obverse statement, it is negative and the predicate of the original statement is replaced by its complement. But the original meaning has not changed.

Premise: Some citizens are voters.
 Obverse: Some citizens are not non-voters.
 Some citizens are not people who are not voters.

Obversion shows how one and the same idea can be expressed either affirmatively or negatively.

3C.1. Exercises:

See if you can determine whether the B statement has the same meaning as the A statement in the following examples.

<u>A</u>	B
1. All women are females.	No women are people who are not females.
2. No men are females.	All men are people who are males.
3. Some cities are overcrowded.	Some cities are not overcrowded.
4. Some workers are not employed.	Some workers are employed.
5. Some students are religious.	Some students are not people who are not religious.

C.II. Terminology

Following are some preliminary terms used in the obverse operation:

Obvertend - the premise of an immediate inference by obversion.

Obverse - the conclusion.

Complement of class A - all things that are not A.

Thus, the complement of the class “citizens” is the class of ‘things that are not citizens’, or the class of non-citizens. The complement of the class “animal” is “non-animal” and is the class of ‘things that are not animals’, such as plants and stones. However, the complement of the class “heroes” is not the class “cowards” but the class of persons that are not heroes or “non-heroes.” For persons who are not heroes are not necessarily cowards. If we use the symbol S to denote the subject class, then the complement of S is non-S. And the complement of non-S is non-non S, or simply S. Accordingly, the complement of the class of non-voters is simply the class of voters.

Using the terms obvertend, obverse, and complement, the rules of obversion are as follows.

C.III. Rules of Obversion

Rule 1. The subject term of the obvertend and its quantity remains unchanged.

Rule 2. Change the copula quality of the obvertend.

Rule 3. Replace the predicate term of the obvertend by its complement.

We can illustrate the rules by the following example:

- Obvertend: All patriots are heroes. (A proposition)
 All people who are patriots are people who are heroes.
- Obverse: No patriots are non-heroes. (E proposition)
 No people who are patriots are people who are not heroes.

Notice that the subject term “patriots” remains unchanged in meaning and in quantity in the obverse. The quantifier “No” has a double function. It keeps the original quantity of the S term universal, but it also changes the quality of the original statement (the obvertend) from affirmative to negative. Thus, the original A proposition has become an E proposition. Lastly, observe that the predicate term of the obvertend has been replaced by its complement, non-P (non-heroes). From the original proposition, “All patriots are heroes,” we have immediately inferred another proposition, “No patriots are non-heroes,” which is equivalent in meaning to the first one.

We can also show by means of the two-circle Venn diagram that the obvertend “All S is P” is equivalent in meaning to its obverse “No S is non-P.” Thus, we have

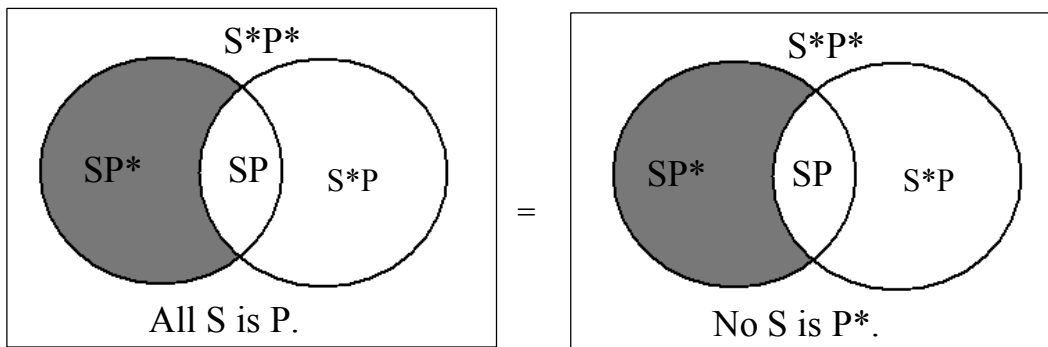

Figure 3.24

Because the diagrams are identical, the meaning of the two statements is the same.

C.IV. Kinds of Obversion

An A statement obverts to an E.

(A) All S is P

(E) No S is P*

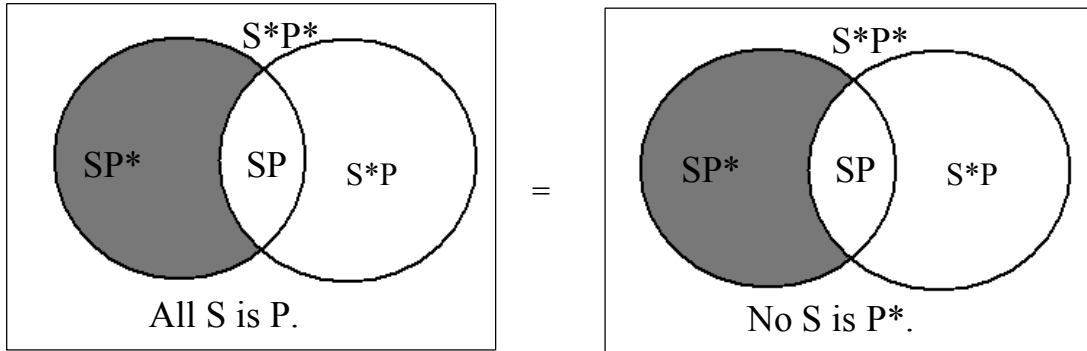

Fig. 3.25

An E statement obverts to an A.

(E) No S is P

(A) All S is P*.

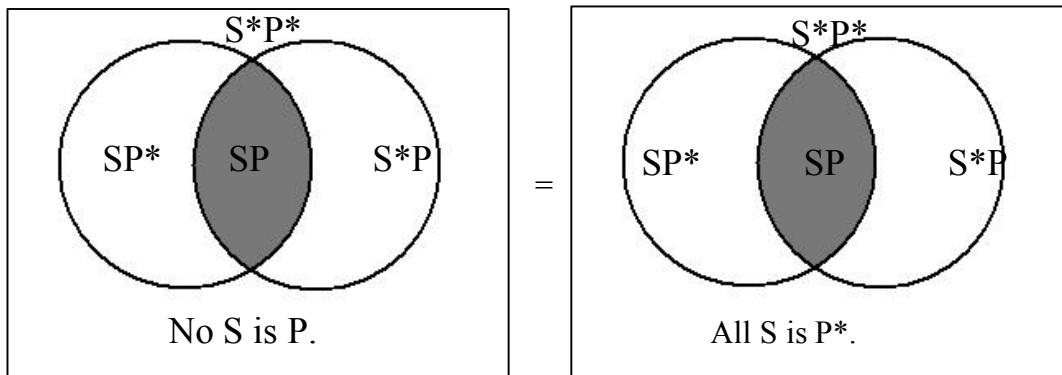

Figure 3.26

An I statement obverts to an O.

(I) Some S is P.

(O) Some S is not P*.

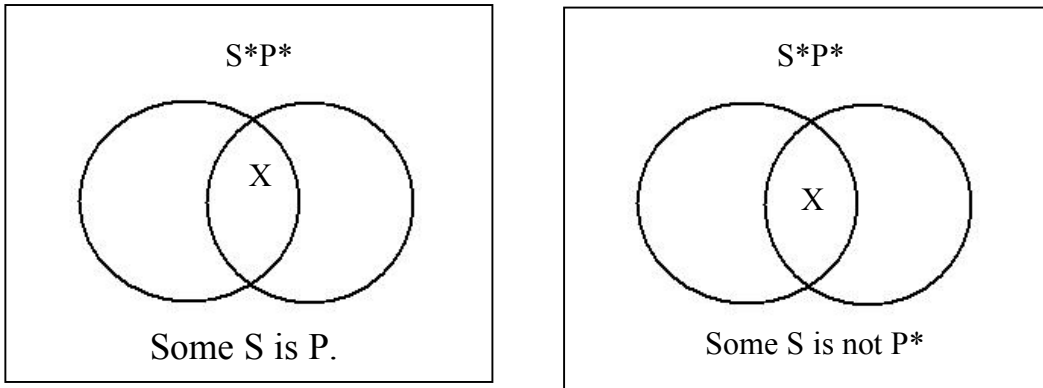

Figure 3.27

An O statement obverts to an I statement.

(O) Some S is not P.

(I) Some S is P*.

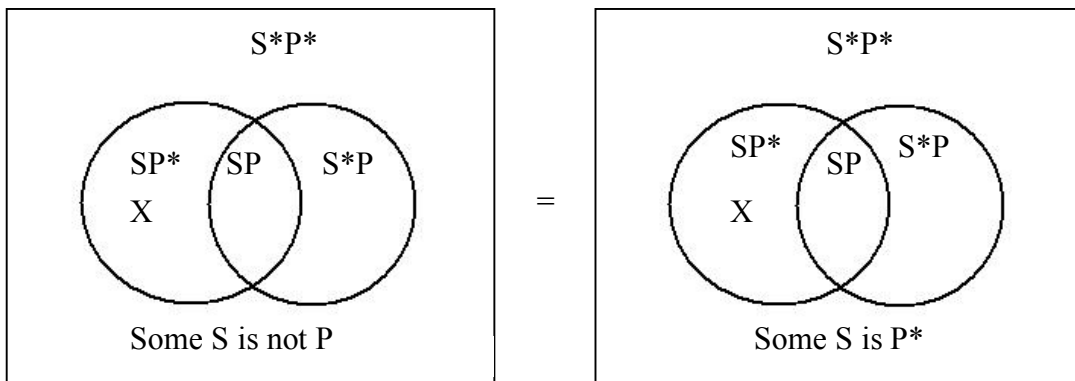

Figure 3.28

3.C.2. Exercises:

Obvert the following:

1. All S is P*. _____

2. No S is P* _____

3. Some S* is P*. _____

4. Some S is not P*. _____

5. All X is Y. _____

6. No L is M*. _____

7. Some R is S*. _____

8. All gold is metal. _____

9. No dog is an invertebrate. _____

10. Some mistakes are avoidable. _____

3.C.3. Exercises: Determine whether the following are valid obversions:

1. Some women are mothers.
Some women are not mothers.

2. Some men are bachelors.
Some men are not non-bachelors.

3. All effects are caused.
No effects are uncaused.
4. Some workers are union members.
Some workers are not union members.
5. All heroes are courageous.
No heroes are cowards.
6. No illiterate person is educated.
All illiterate persons are uneducated.
7. All oppressors are inhumane.
No oppressors are humane
8. Most scientists are non-philosophers.
Most scientists are not philosophers.
9. Some cigarettes are not filtered.
Some cigarettes are unfiltered.
10. No poor person is wealthy.
All poor persons are persons who are not wealthy .
11. Some scientists are prejudiced.
Some scientists are not prejudiced.
12. Mary admires Jane.
Mary is not a person who does not admire Jane.

13. Some good people are not people who are religious.
Some good people are people who are religious.

14. Some actions are ethical.
Some actions are not unethical.

15. All guests are welcome.
No guests are unwelcome.

3.C.4. Exercises: Translate each of the following into A,E,I, or O propositions, with subject and predicate in genus-difference form (p.69); then obvert.

1. Every fish is a vertebrate.

2. Some animals are intelligent.

3. Every mammal is warm-blooded.

4. Some drinks are intoxicating.

5. Every non-Aryan is non-inferior.

6. No fish are unable to swim.

7. No war is without harm to the innocent.

8. No education is inexpensive.

9. All indigent families are without resources.

10. Many workers are unemployed.

11. All people who are not registered are non-students.

12. Some non-Communists are not non-conservatives.

3.C.5. Exercise: For each statement below, circle the letter of the obverse.

1. Some government officials are not people who are not clear about morality
 - a. Some government officials are people who are not clear about morality
 - b. Some government officials are not people who are people who are clear about morality.
 - c. Some people who are government officials are people who are not clear about morality.
 - d. Some government officials are people who are clear about morality
 - e. Some people who are government officials are not people who are clear about morality.

2. All people who are not poor are unable to lead productive lives.
 - a. No people who are not poor are not able to lead productive lives.
 - b. No people who are poor are able to lead productive lives.
 - c. No people who are not poor are able to lead productive lives.
 - d. No people who are poor are non-unable to lead productive lives.
 - e. No people who are poor are people who are not able to lead productive lives.

3. Some steelworkers that are not employed are involved in activities that are interesting.
 - a. Some steelworkers that are employed are involved in activities that are not interesting.
 - b. Some steelworkers that are not employed are not involved in activities that are interesting.
 - c. Some steelworkers that are not employed are not involved in activities that are not interesting.
 - d. Some steelworkers that are employed are not involved in activities that are interesting.
 - e. Some steelworkers that are employed are not involved in activities that are not interesting.

4. No people who are in love are able to ignore a beautiful sunset.
 - a. All people who are not in love are able to ignore a beautiful sunset.
 - b. All people who are not in love are not able to ignore a beautiful sunset.
 - c. All people who are not in love are people who are not able to ignore a beautiful sunset.
 - d. All people who are in love are unable to ignore a beautiful sunset.
 - e. All people who are in love are people who are able to ignore a beautiful sunset.

D. CONVERSION

Conversion is the process of drawing an immediate inference or conclusion (called the converse) from an original statement (called the convertend), by having the subject and predicate trade places.

Venn Diagram Illustration of Conversion.

E Proposition:

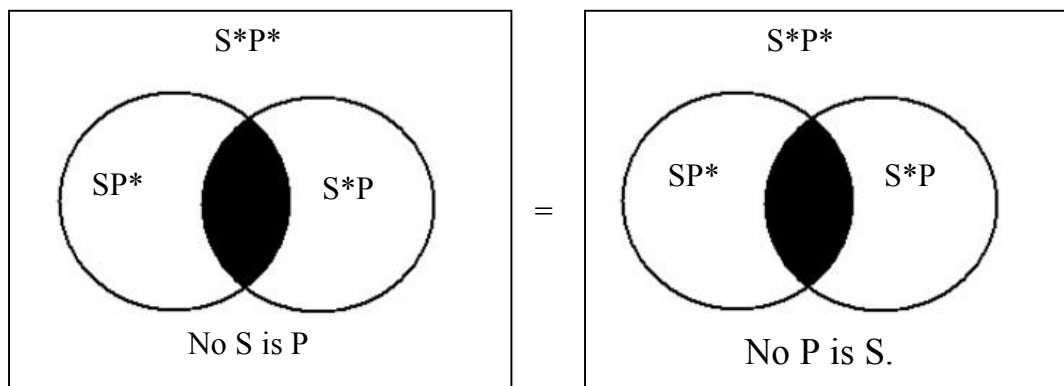

Figure 3.29

I Proposition:

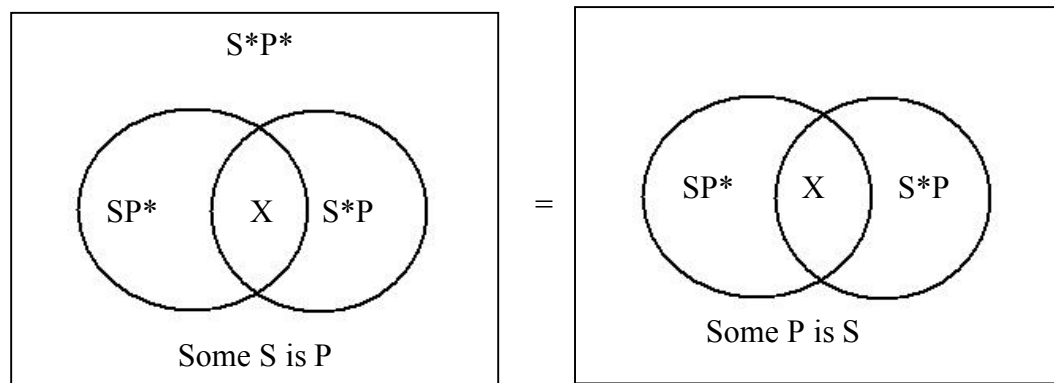

Figure 3.30

For E and I propositions, the diagram for the convertend is the same as that for the converse. Therefore, they are equivalent.

O Proposition:

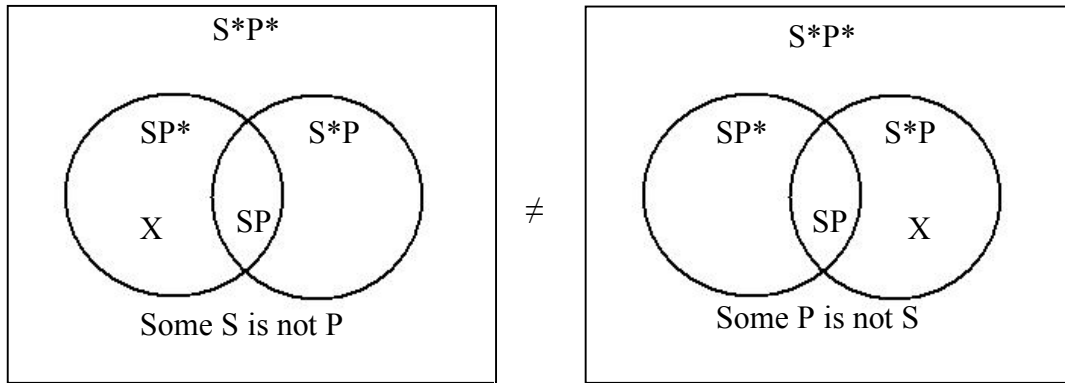

Figure 3.31

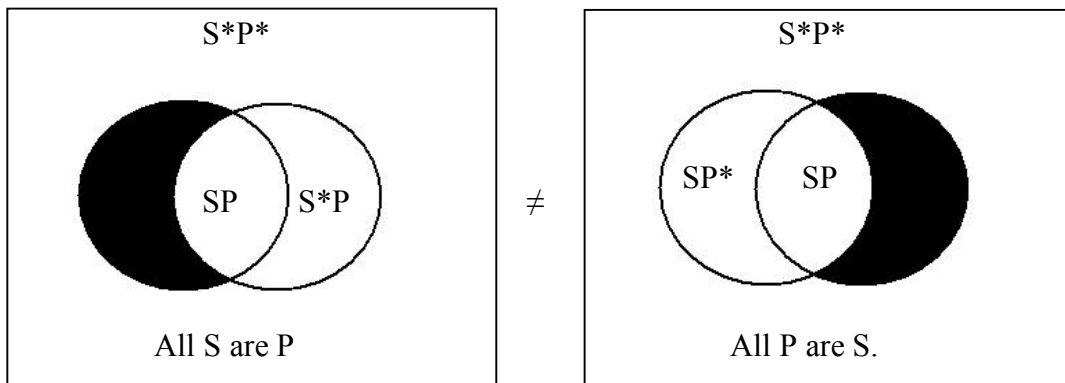

Figure 3.32

Clearly the diagrams of the converse and convertend are not identical in the case of A and O propositions.¹ Thus the A and O propositions are not equivalent in meaning to their converses.

VI. Kinds of Conversion

A Proposition:

(A) All S is P All gold is metal.

(A) All P is S All metal is gold.

E Proposition:

(E) No S is P No dog is invertebrate.

(E) No P is S No invertebrate is a dog.

I Proposition :

(I) Some S is P Some men are oppressors.

(I) Some P is S Some oppressors are men.

O proposition:

(O) Some S is not P Some animals are not horses.

(O) Some P is not S Some horses are not animals.

¹ We can, however, infer "Some P are S" from "All S are P" if we make the existential assumption that there exists at least one member of the class S. The resulting converse is limited (from "All S are P" to "Some P are S"). Hence, it is called a conversion by limitation or per accidens. More on this in the second part of the chapter.

3.D.1. Exercises: Conversion

A. Translate the following statements into Genus-Difference format, convert, and state whether the converse is equivalent to the convertend.

1. O.J. Simpson played football.

2. Some machines are noisy.

3. Most dogs are not red.

4. Many lawyers are unethical.

5. Christians always love one another.

6. Some advocates are needed in impoverished communities.

7. All fish swim.

8. Some plants are not edible.

9. No happy man is sad.

10. Most educated people succeed in life.

11. Honesty is never the best policy.

12. All men are organisms.

13. All communists hate capitalism.

14. Some students who do not study fail their exams.

3. D.2 Exercises:

B. Determine whether the following immediate inferences are valid (V) or invalid (I).

- _____ 1. Some detectives are not policemen, therefore, some policemen are not detectives.
- _____ 2. All animals are mobile, therefore, all mobile things are animals.
- _____ 3. Most politicians are corruptible, therefore, some corruptible people are politicians.
- _____ 4. All mammals are warm-blooded animals, therefore, all warm-blooded animals are mammals.
- _____ 5. All men die, thus some things that die are men.
- _____ 6. Some witnesses do not tell the truth, therefore, some people who do not tell the truth are witnesses.
- _____ 7. No plant has sense organs, therefore, no possessors of sense organs are plants.
- _____ 8. Some rich people are unhappy, therefore, some unhappy people are rich.

- _____ 9. Some defeats are not embarrassing, therefore, some embarrassing things are not defeats.
- _____ 10. Every dishonest person is untrustworthy, therefore, every untrustworthy person is dishonest.
- _____ 11. We can infer that some retired workers are elderly people, since some elderly people are retired workers.
- _____ 12. If no stones are living, we can infer immediately that no living thing is a stone.
- _____ 13. It is correct to infer that some workers are users of public transportation from the fact that some users of public transportation are workers.

3. D.3. Exercises: For each statement below, circle the letter of the equivalent converse.
If there is no equivalent converse, circle the letter indicating “none.”

1) No man is able to live without a challenge.

- a) All men are able to live with a challenge.
- b) Some men are able to live with a challenge.
- c) All people who are able to live without a challenge are not men.
- d) No people who are able to live without a challenge are men.
- e) None.

2) Some cats are stronger than dogs.

- a) Some cats are not stronger than dogs.
- b) Some things stronger than dogs are cats.
- c) Some dogs are stronger than cats.
- d) Some things stronger than dogs are not things stronger than cats.
- e) None.

3) Some tall men are not short.

- a. Some men who are short are not tall
- b. Some men who are tall are men who are not short.
- c. Some men who are not short are not men who are tall.
- d. Some men who are not short are men who are not tall.
- e. None.

4) All chairs are made for rough treatment.

- a. All things made for rough treatment are chairs.
- b. Some things made are chairs for rough treatment
- c. All things that are chairs are things not made for rough treatment.
- d. Some things made for rough treatment are chairs.
- e. None.

E. Contraposition

We form the contrapositive of a statement by replacing its subject with the compliment of its predicate and replacing its predicate with the compliment of its subject. Thus we have:

Original	Contrapositive
All S is P	All P* is S*
No S is P	No P* is S*
Some S is P	Some P* is S*
Some S is not P	Some P* is not S*

In each of these cases, the contrapositive is derived from the original statement by a series of immediate inferences:

Statement 1: the original statement

Statement 2: obverse of statement 1

Statement 3: converse of statement 2

Statement 4: obverse of statement 3 = the contrapositive of the original

Original	obverse	converse	obverse
All A are B	No A are B*	No B* are A	All B* are A*
No A are B	All A are B*	All B* are A	No B* are A*
Some A are B	Some A are not B*	Some B* are not A	Some B* are A*
Some A are not B	Some A are B*	Some B* are A	Some B* are not A*

While the obverse operation always gives a statement of equivalent truth value, the converse operation does not. In deriving the contrapositive of both the E and I propositional forms, the conversion operation is not a valid inference and does not necessarily produce an equivalent propositional form. But for the A and O forms, if 'All A are B' is true, then 'All B* are A*' is true; and if 'Some A are not B' is true, then 'Some B* are not A*' is true.

The operations of obversion, conversion, and contraposition allow us to say simple things in complex ways. It also helps us to decipher complex language and reveal hidden meaning.

3.E.1. Exercises: Write out the contrapositive of each of the following statements:

- 1) All mammals are animals.
- 2) Some animals are not mammals.
- 3) Some mammals are not animals.
- 4) Some mammals are things that are not animals.
- 5) No things that are not mammals are animals.
- 6) All things that are not mammals are things that are not animals.
- 7) All things that are not animals are things that are not mammals.
- 8) No mammals are thing that are not animals.
- 9) Some animals are things that are not mammals.

10) Some things that are not mammals are not things that are not animals.

3.E.2. Exercises: Determine which of the following are valid arguments:

- 1) All dogs are things that are not cats. Therefore, all cats are things that are not dogs.
- 2) No dogs are things that are not cats. Therefore, no cats are things that are not dogs.
- 3) Some things that are dogs are cats. Therefore, some things that are cats are dogs.
- 4) Some dogs are things that are not cats. Therefore, some cats are things that are not dogs.
- 5) Some things that are not cats are things that are not dogs. Therefore, some dogs are cats.

F. CATEGORICAL SYLLOGISMS

In this part of the chapter, we will consider arguments involving mediate inference, where there is more than one premise. The classic example of mediate inference is the categorical syllogism. A **syllogism** is a deductive argument in which a conclusion is inferred from two premises. A categorical syllogism is a deductive argument in which the conclusion and the two premises are all categorical propositions.

Introduction

In everyday life, constant use is made of the categorical syllogism. We can illustrate its use in the current discussion on the justification of preferential treatment for women and other groups that have been historically denied opportunities.

- A: I say that women deserve preferential treatment because they have been exploited and discriminated against. All exploited people have a right to compensation, and preferential treatment is a form of compensation for historical and current injustice.
- B: I disagree with your position. I maintain that preferential treatment is unfair. All awarding of jobs and educational opportunities should be based on merit alone.
- A: How can you talk of fair competition for jobs and education based on merit when women have been and continue to be denied opportunities available to men? There is no fairness in merit alone when women have been systematically disadvantaged relative to men.

B: But if you give preference to those who are incompetent, then the quality of goods and services will be lowered. You don't want an incompetent doctor treating you, just because some bureaucrat had to fill a quota.

A: I deny your premise that preferential treatment rewards incompetents. Preferential treatment means that among all those found competent, women should be given preference. It does not follow that the quality of goods and services will be lowered.

Let us now formalize the syllogisms contained in the foregoing discussion:

A: All people who have been historically exploited have a right to be compensated.

All women have been historically exploited.

All women have a right to compensation.

Some forms of preferential treatment are forms of compensation.

Some form of compensation is deserved by women.

Some form of preferential treatment is deserved by women.

B: All awarding of jobs and educational slots on the basis of merit is fair competition.

Preferential treatment does not award jobs and educational slots on the basis of merit.

Preferential treatment is not fair competition.

- A: Some educationally disadvantaged peoples are unable to compete on the basis of merit alone.
Some women are educationally disadvantaged people.
Some women are unable to compete on the basis of merit alone.
- B: All cases where employment and educational slots are awarded through preferential treatment are cases that lower the quality of goods and services in the country.
Preferential treatment awards jobs and educational slots to less competent people.
Preferential treatment lowers the quality of education and services in the country.
- A: Awarding employment and educational slots to competent women over competent men does not lower the quality of education and services in the country.
Preferential treatment awards jobs and educational slots to competent women over competent men.
Preferential treatment does not lower the quality of education and services in the country.

Of course, most people do not normally argue in the formal way shown above. In normal discussions, the conclusion sometimes appears first and, then, the reasons or premises to support the conclusion follow. This is the case in A's first argument. Again, in everyday arguments, sometimes not all the premises are explicitly mentioned. It is left to the listener to furnish the missing premise. This is the case in B's first argument.

In order to analyze an argument, all the premises should be explicitly stated and the conclusion placed last. In this section, we will explore not only how to put syllogisms into this standard form, but more importantly, how to distinguish valid from invalid syllogisms.

I. The Structure of the Categorical Syllogism

The standard form of a categorical syllogism has (1) three propositions, and (2) three terms.

The three propositions are:

1. The major premise
2. The minor premise
3. The conclusion

The three terms are:

1. The major term P
2. The minor term S
3. The middle term M

Consider the following example of a categorical syllogism:

All animals are organisms.

All bears are animals.

Therefore, all bears are organisms.

II. Terms: The first step in evaluating any argument is identifying its conclusion.

From our earlier study of distinguishing premises from conclusions, we know that the word “therefore” is a conclusion indicator. Thus, the last statement in the syllogism is the conclusion, and the **major term** is the predicate term, P, of the conclusion. In the syllogism given, the term “organisms” is the major term of the syllogism.

The **minor term** is the subject term, S, of the conclusion. In this case, it is the term “bear.” The predicate term of the conclusion is called the major term because the predicate of a proposition is usually wider in extension than the subject term. Thus, the predicate term, “organisms,” is wider in scope than the subject term, “bear.”

The **middle term** is the term, M, that appears only in the premises and connects the major and minor terms. In this case, it is the term “animals.”

III. Premises:

The **major premise** is the premise that contains the major term. In this case, the major premise is “All animals are organisms.”

The **minor premise** is the premise that contains the minor term. In this case, the minor premise is “All bears are animals.”

In a **standard-form categorical syllogism**, the major premise must come first, next, the minor premise, and lastly, the conclusion. The example above thus has the following structure:

All animals (M) are organisms (P). (Major premise)

All bears (S) are animals (M). (Minor premise)

All bears (S) are organisms (P). (Conclusion)

In a lateral format, this would be written:

All M are P. / All S are M. // All S are P.

Observe that each term appears twice in the syllogism. The major term (P) appears once in the conclusion and once in the major premise. The minor term (S) appears once in the conclusion and once in the minor premise. The middle term (M) appears once in the major premise and once in the minor premise, but it never appears in the conclusion.

If we eliminate the quantity and the copula and give the skeletal structure alone, then we have the following figure:

M	P
S	M
S	P

Figure 3.33

IV. Figure and Mood of the Syllogism

The S, P, and M terms can vary their positions in the premises of the syllogism to produce different arrangements known as figures of the syllogism. There are four possible figures illustrated as follows:

	Figure 1	Figure 2	Figure 3	Figure 4
Major	M P	P M	M P	P M
Minor	S M	S M	M S	M S
Concl.	S P	S P	S P	S P

Figure 3.34

3.F.1. Exercises: Determine the figure of the following syllogisms.

- (1) All dogs are animals.
All German Shepherds are dogs.
All German Shepherds are animals.

- (2) No saints are sinners.
Some men are sinners.
Some men are not saints.

- (3) All students are learners.
Some students are children.
Some children are learners.

- (4) All leopards are spotted animals.
Some spotted animals are cats.
Some cats are leopards.

- (5) All X are Y.
All Z are Y.
All Z are X.

- (6) No L are M.
All M are R.
No R are L.

- (7) All horses are animals with backbone.
Some mammals are horses.
Some mammals are not animals with backbone.

- (8) No men are women.
All mothers are women.
No mothers are men.
- (9) No winners are losers.
Some losers are gamblers.
Some gamblers are not winners.
- (10) All laborers are wage earners.
Some laborers are underpaid people.
Some underpaid people are wage earners.
- (11) No Alaskans are Alabamans.
All Alabamans are Southerners.
No Southerners are Alaskans.
- (12) Some insects are spiders.
Some animals are insects.
Some animals are spiders.

A syllogism is characterized by its figure and also by its mood. By **mood** we mean the kind of proposition, A, E, I, or O, that appears as major premise, minor premise and conclusion. For example, AOI would mean that the major premise is an A proposition, the minor premise is an O proposition and the conclusion is an I proposition. The mood and figure of a syllogism can be presented in a box giving the figure of the syllogism and specifying the form of the major premise, minor premise, and conclusion.

Thus, a syllogism with the form AAA-1 would have the following box form:

A	M P
A	S M
A	S P

3.F.2. Exercises:

Use S, P, and M to write out the syllogistic forms corresponding to the following :

1. AAA-2

2. AAA-3

3. IAO-3

4. EAO-1

5. AII-2

6. OAA-4

7. OEO-4

8. EAA-1

9. IAA-3

10. EEE-1

11. OAO-2

12. IEO-1

13. OAI-3

14. EAO-4

15. IAI-2

3.F.3. Exercises: Put the following syllogisms into standard form and determine the mood and figure of each. The steps to follow are:

- a. Translate the statements into categorical form if needed.
 - b. Find the conclusion and locate the subject and predicate terms so that the major and minor premises can be found.
 - c. Write the major premise first, next the minor, and finally the conclusion.
 - d. Determine the mood and figure.
1. All Nigerians are men because all Nigerians are Africans and all Africans are men.
 2. All guns are dangerous weapons, but no dangerous weapons are suitable toys for children; consequently, no guns are suitable for children.
 3. No babies are adults, but all adults are full grown; it follows that no babies are full grown.
 4. All things that are oxygen expand when heated because all things that are oxygen are gases, and all gases expand when heated.
 5. No aircraft carriers are ocean liners, so no warships are ocean liners since all aircraft carriers are warships.
 6. All nuclear missiles are man-made inventions; therefore, some man-made inventions are not Russian-made inasmuch as some nuclear missiles are not Russian-made.
 7. All oranges are healthy, since everything that contains Vitamin C is healthy and all oranges contain Vitamin C.

8. No economy that exists in mainland China is individualistic, so no capitalist economy exists in mainland China, since all capitalist economies are individualistic.
9. No immoral person is a good example to the young, so no child molesters are good examples to the young, since they are immoral persons.
10. All theists are believers in God, but no people who are believers in God are atheists; consequently, no theist is an atheist.
11. All revolutionaries advocate change and so do all enslaved peoples. Hence, all enslaved peoples are revolutionaries.
12. All people love a winner, but no losers love winners, so no losers are people.
13. All neurotic children are maladjusted individuals, and some neurotic children are products of neurotic parents, so some maladjusted individuals are products of neurotic parents.
14. All human beings are organisms because all human beings are living, and all living things are organisms.
15. All books of physics are scientific textbooks; but no book of poetry is a scientific textbook, consequently, no book of physics is a book of poetry.
16. No scientist is a dumb person because no dumb person is knowledgeable, and all scientists are knowledgeable.
17. Every scholar is deserving of praise, since every scholar is hard-working and all hard-working people are deserving of praise.

II. The Rules Method for Testing Validity.

The rules method is not only simple and quick, but that it also gives the specific fallacy involved in an invalid syllogism. One has to remember only six rules. If a categorical syllogism does not violate any of these rules, then it is valid, but if even one rule is violated, then it is invalid. The six rules are as follows:

Rule 1: The middle term must be distributed (universal) in at least one premise.

A violation of Rule 1 commits the fallacy of the **undistributed middle term**.

Rule 2: No term can be distributed in the conclusion which is undistributed in the premise.

A violation of Rule 2 commits either the fallacy of the **illicit minor term** or the fallacy of the **illicit major term**.

Rule 3: No standard form categorical syllogism is valid which has two negative premises.

A violation of Rule 3 commits the fallacy of **exclusive premises**.

Rule 4: A negative premise requires a negative conclusion;
a negative conclusion requires a negative premise.

A violation of Rule 4 commits either the fallacy of drawing **an affirmative conclusion from negative premises** or the fallacy of drawing a **negative conclusion from affirmative premises**.

Rule 5: From two universal premises a particular conclusion cannot be drawn.

A violation of Rule 5 commits the **existential fallacy** of assuming a universal statement is non-empty.

Rule 6: A valid syllogism must contain only three terms, each of which is used in the same sense throughout the argument.

A violation of Rule 6 commits the **fallacy of four terms**. A specific form of this fallacy is called the fallacy of the ambiguous middle term.

Rule 1: The middle term must be distributed at least once.

The function of the middle term is to serve as a basis from which we can draw a conclusion about the relation between the subject and predicate terms of the syllogism. In order for this to be possible, it must be distributed in either the major premise or the minor premise. To illustrate, consider the following example:

All horses are animals.	(major premise)
All men are animals.	(minor premise)
All men are horses.	(conclusion)

Recall that a term is distributed if it refers to all members of the class designated by that term. Otherwise it is undistributed. Thus, the middle term "animal" is undistributed in the major premise because not all, but only some animals are horses. Similarly, the term "animal" in the minor premise asserts only that some animals are men. It is invalid to draw the conclusion that "All men are horses" because that part of the animal class which refers to horses is not identical with that part of the animal class which refers to men.

A convenient way of detecting violations of Rules 1 and 2 is by the use of the box method, which illustrates the form of the syllogism. Using the box method for the syllogism above, the first column determines the mood and the next two columns determine the figure of the syllogism:

A	P	M
A	S	M
A	S	P

Figure 3.43

The following table recounts the distribution of subject and predicate terms for each of the categorical propositions:

Quantity of S			Quantity of P	
A	distributed	(d)	undistributed	(u)
E	distributed	(d)	distributed	(d)
I	undistributed	(u)	undistributed	(u)
O	undistributed	(u)	distributed	(d)

We now determine the quantity (distributed or undistributed) for each term in the premises and conclusion as follows:

A	Pd	Mu
A	Sd	Mu
A	Sd	Pu

If M is undistributed in both premises, then a violation of Rule 1 occurs, and we have the fallacy of the undistributed middle term.

Exercises for Rule 1: Determine whether the following syllogisms have a distributed middle term:

1. Some basic rights are inalienable.

All persons have basic rights.

All persons have inalienable rights.

2. All organisms are cellular.

All animals are cellular.

All animals are organisms.

3. No cars are inexpensive.

Some Chevrolets are cars.

Some Chevrolets are not inexpensive.

4. No As are Bs.

All Cs are As.

No Cs are Bs.

5. No form of slavery is moral.

Some marriages are forms of slavery.

Some marriages are not moral.

6. Some trees are deciduous.

All oaks are trees.

All oaks are deciduous.

7. Most good singers are female.

Ross is a good singer.

Ross is female.

8. All poisonous things are dangerous.

All rattlesnakes are poisonous.

All rattlesnakes are dangerous.

9. Many mayors are honest people.

Some town officials are mayors.

Some town officials are honest people.

10. Some gangsters are educated.

Some educated people are not honest.

Some honest people are not gangsters.

Rule 2: No term can be distributed in the conclusion that is not distributed in the premises.

In essence, this rule states that the conclusion of a valid argument cannot assert more than is asserted implicitly in the premises. An undistributed term is one that refers to only some members of a class. One cannot apply to all members of that class what is true of only a part of it. The following example illustrates a violation of Rule 2:

All cows are females.

All cows are mammals.

All mammals are females.

In the minor premise, the S term "mammal" is undistributed, while in the conclusion the S term is distributed. We can clearly see a violation of the rule using the box method:

A	Md	Pu
A	Md	Su
A	Sd	Pu

3.44

In the minor premise Su translates to "Some S" (Some mammals are cows), while in the conclusion, Sd translates to "All S" (All mammals are females). To infer more in the conclusion than what the premise allows is to make an illicit inference; hence, the fallacy of overextending the S term is called the fallacy of the illicit minor.

The following is an example of an overextension of the major or P term in the conclusion:

All communists are radicals.
 No communists are capitalists.
 No capitalists are radicals.

If it is difficult to see the flaw in this argument, the box method will help us see it more clearly:

A	Md	Pu
E	Md	Sd
E	Sd	Pd

3.45

Observe that the major term P in the major premise is undistributed. In other words, it is making a claim about some radicals. Yet, in the conclusion, we see that the major term P

is distributed. It is making a claim about all radicals. The conclusion says more than the premises allows. The fallacy of overextending the major term P in the conclusion is called the fallacy of the illicit major.

ii. Exercises for Rule 2.

Examine the following syllogisms for a violation of Rule 2. Name the specific fallacy of overextension, where applicable.

1. All poodles are domestic animals.

All poodles are dogs.

All dogs are domestic animals.

2. All Republicans are supporters of business.

No Republicans are supporters of labor.

No supporters of labor are supporters of business.

3. Some philosophy courses are interesting.

Some college courses are not interesting.

Some college courses are not philosophy courses.

4. All men who understand children make good fathers.

No men who understand children are impatient.

No impatient men make good fathers.

5. All criminal acts are illegal.

All criminal acts are wicked deeds.

All wicked deeds are illegal.

iii. Exercises for Rules 1 and 2:

Determine whether there is a violation of rules 1 or 2 in the following syllogistic forms. Name the fallacy involved, where applicable.

- | | | |
|---------------|--------------------|-----------------|
| 1. All P is M | 2. All M is P | 3. All M is P |
| All S is M | All M is S | No S is M |
| All S is P | All S is P | No S is P |
| 4. All P is M | 5. Some P is not M | 6. All P is M |
| Some M is S | All S is M | Some S is not M |
| Some S is P | Some S is not P | Some S is not P |

Rule 3: No standard-form categorical syllogism is valid which has two negative premises.

This rule follows naturally from the nature of a syllogism. A syllogism allows us to determine the relationship between S and P through their respective relationships with M. If neither S nor P is related to M, we really have no mediation, and hence, no syllogism. Therefore, from two negative premises, no conclusion can be drawn as to the relationship between S and P.

Some illustrations may make this clearer:

No gentleman is ill-mannered.

No lady is ill-mannered.

No lady is a gentleman.

The conclusion of this syllogism may be true, but its truth cannot depend on the truth of the premises used. The subject “lady” and the predicate “gentleman” are both excluded

from the class of ill-mannered individuals. Therefore, there is no way to relate the class of gentleman to the class of ladies. All we can say is that neither a gentleman nor a lady is ill-mannered, but this tells us nothing about the relationship between ladies and gentlemen.

To test for a violation of this rule, examine the mood of the syllogism. A violation occurs if any of the following combinations appear as premises: EE, EO, OE, OO.

Rule 4: A negative premise requires a negative conclusion; a negative conclusion requires a negative premise.

If both S and P are excluded from M, then we have a violation of Rule 3. If one of the terms includes M and the other excludes M, then S and P must exclude each other. Thus, the conclusion must be a negative statement. Consider the following premises:

No males are females.

Some females are politicians.

The only possible valid relationship that could exist between politicians and males is “Some politicians are not males”. Whenever either premise of a syllogism is negative, then the conclusion must be negative. Otherwise, we commit the fallacy of drawing an affirmative conclusion from a negative premise.

Rule 5: From two universal premises a particular conclusion cannot be drawn.

In the Venn diagrams, the particular propositions I and O were diagrammed by placing an x in the appropriate space. The x implies that there exists at least one member of the class in which it is placed. Thus, particular propositions are by definition said to have existential import.

But universal propositions do not always have existential import. That is, they do not always assert the existence of objects. For example, the statement “All students who fail

the test are students who must take a make-up exam” does not imply the existence of anyone who has or will fail the test. Many universal statements are non-committal about the existence of members of the subject class S. Given this fact, we cannot claim that there exists at least one member of S. A violation of Rule 5 is called the **existential fallacy**.²

iv. Exercises for Rules, 3, 4 and 5:

a. Determine whether there is a violation of Rules 3, 4 and/or 5 in the following moods. Name the fallacy where appropriate.

- | | | | |
|--------|---------|--------|--------|
| 1. EEO | 2. AAE | 3. AEO | 4. AOI |
| 5. OEO | 6. AAI | 7. OOO | 8. AAA |
| 9. IEO | 10. EAO | | |

b. In order to have a valid argument, determine what form, (A, E, I or O), the conclusion of the following premises should have, if any.

- | | | | |
|-------|--------|-------|-------|
| 1. AA | 2. AE | 3. AI | 4. AO |
| 5. EA | 6. EI | 7. IA | 8. OA |
| 9. IE | 10. IO | | |

Rule 6: A valid syllogism must contain only three terms, each of which is used in the same sense throughout the argument.

The conclusion of a categorical syllogism asserts a relationship between S and P. This relationship is justified on the basis of combining premises that assert a relationship between S and M, and between P and M. If S is related to term M_1 and P is related to term M_2 , and $M_1 \neq M_2$, there is no way that one can use this information to determine the relationship between S and P.

² In illustrating immediate inferences (square of opposition, obversion, and conversion), the assumption was made that S was non-empty. That is, that there existed some x in S. But in illustrating syllogistic inference, it will not be assumed that S is non-empty. This will give us practice in using inference procedures that do and do not make the existential assumption.

An example of a violation of Rule 6 is the following:

All men are rational animals.

No women are men.

No women are rational animals.

In this syllogism, the middle term "men" can be used with two meanings. In the major premise it may be used inclusively, as synonymous with all human beings and would refer to both males and females. In the minor premise, "men" may be used in an exclusive sense, referring to the male of the species only. The middle term, therefore, is really two terms. Thus, we have four terms in the syllogism. A violation of rule 6 is called the fallacy of four terms. A particular instance of the fallacy of four terms is called the fallacy of the ambiguous middle, such as the one above. It is not the middle term alone, however, which can be ambiguous. The S and the P terms can also be ambiguous.

Another instance of the occurrence of four terms involves the collective and divisive use of a term in the same syllogism. A term is used collectively when it is the predicate of the subject taken as a group. For example, in "All the angles of a triangle are 180 degrees," the term, "180 degrees" is applied to the three angles as a group, not separately. Hence, the term is used in the collective sense. A term is used divisively when it is the predicate of the members of the subject class taken individually. Thus, in "All the boys in our family are college-educated" the predicate, "college-educated" is used divisively, and applied to each individual separately. The following is an example of a syllogism in which the middle term is used both collectively and divisively:

Our team played gloriously last night.

Jill King did not play gloriously last night.

Jill King is not a member of our team.

The middle term “played gloriously last night” is applied to the team taken as a group in the major premise, while in the minor premise it is applied to one individual player on the team. In this way, the fallacy of the ambiguous middle term is committed.

An essential condition for a valid syllogism is that there must be only three terms each of which is used in the same sense throughout the argument. A vague middle term prevents us from drawing a decisive conclusion. Terms such as "democracy", "free enterprise", "law and order", "peace", "success", and "freedom", when used in more than one sense in an argument, often result in a fallacy of four terms. In the chapter on informal fallacies, other fallacies resulting from the ambiguity of terms and statements will be discussed.

v. Exercises for Rule 6:

1. The end of life is happiness.

Death is the end of life.

Therefore, death is happiness.

2. To live according to nature is good.

Every man that steals lives according to his nature.

Therefore, every man that steals is good.

3. Mother is a six-letter word.

Mary is a mother.

Therefore, Mary is a six-letter word.

4. All cardinals are birds.

Stan Musial was a Cardinal.

Stan Musial was a bird.

5. Nothing is better than God.

But something is better than nothing.

Therefore, something is better than God.

6. Every Liberal is loyal to his party.

But anyone who is broad-minded is a liberal.

So, anyone who is broad-minded is loyal to his party.

7. Everything fast is soon gone.

This color is fast.

Therefore, this color is soon gone.

8. All who know how to drive know how to start a car.

All good golfers know how to drive.

So, all good golfers know how to start a car.

9. Every lion is a feline.

Jai Kel was the lion of Cudah.

So, Jai Kel was a feline.

10. All criminal actions are punishable by law.

All libel suits are criminal actions.

Therefore, all libel suits are punishable by law.

vi. Exercises on all Rules:

Translate into categorical form, if necessary, then test the syllogisms for validity by the use of the Rules Method.

1. All judges are lawyers.

Some African Americans are not judges.

Some African Americans are not lawyers.

2. All good leaders are practicers of what they preach.

Many elected officials are not practicers of what they preach.

Many elected officials are good leaders.

3. Many government officials lack credibility.

No truthful man lacks credibility.

No truthful man is a government official.

4. All efforts to end a war are praiseworthy.

All military orders to massacre civilians are efforts to end a war.

All military orders to massacre civilians are praiseworthy.

5. No radicals are non-violent.

Some revolutionaries are radicals.

Some revolutionaries are non-violent.

6. All big stockholders oppose increased corporate taxes.

All who oppose increased corporate taxes are rich people.

All rich people are big stockholders.

7. Most Republicans are pro-business.

Most pro-business people are rich.

Most rich people are Republicans.

8. No addictive drugs can be bought without a doctor's prescription.

Some drugs can be bought without a doctor's prescription.

Some drugs are not addictive.

9. All free countries are true democracies.

No totalitarian states are free countries,

No totalitarian states are true democracies.

10. Many good typists are good stenographers.

Every good secretary is a good typist.

So, every good secretary is a good stenographer.

11. All diamonds are stones.

All diamonds are precious.

Some precious things are stones.

12. No glass is a good conductor of electricity.

All glass is non-metal.

No non-metal is a good conductor of electricity.

13. Many teachers have college degrees.

Many educators are teachers.

Many educators have college degrees.

14. No designing person is trustworthy.

All city planners are designing persons.

No city planners are trustworthy.

15. All who understand the young are young.

No old people are young.

No old people understand the young.

16. No babies can reason.

No one who does not know logic can reason.

Thus, anyone who doesn't know logic is a baby.

17. No men are perfect.

No dogs are men.

Therefore, no dogs are perfect.

18. Some men make good husbands.

All men are imperfect.

Some imperfect beings do not make good husbands.

19. No government that is divided can stand.

The U. S, government is divided (into legislative, judicial and executive branches.)

So, the U.S. government cannot stand.

20. All members of our club donated a thousand dollars to charity,

Peter is a member of our club.

So, Peter donated a thousand dollars to charity.

3.G.3. Exercises: Name the rules broken and the fallacies committed by the following invalid syllogisms:

1. AAA-3

2. AAA-2

3. AII-2

4. EAA-1

5. EAO-4

6. EAO-1

7. EEE-1

8. IAO-3

9. IAI-2

10. IEO-1

11. IAA-3

12. OEO-4

13. OAA-4

14. OAI-3

15. OAO-2

I. The Venn Diagram Method for Testing Validity

A syllogism is valid if the conclusion necessarily follows from the premises. The three-circle Venn diagram offers us a technique that proves whether the conclusion necessarily follows from the premises, or not. This technique involves combining the Venn diagram of the premises in such a manner as to implicate the Venn diagram of the conclusion. A syllogism is valid if the Venn diagram of the conclusion is contained in the combined Venn diagrams of the premises.

Let us proceed to explain the Venn diagram technique of determining validity. In a previous chapter we introduced the two-circle Venn diagram that showed the class inclusion or exclusion of two terms, S and P. In a syllogism, however, we have three terms, S, P, and M. Consequently, we need three overlapping circles as shown below:

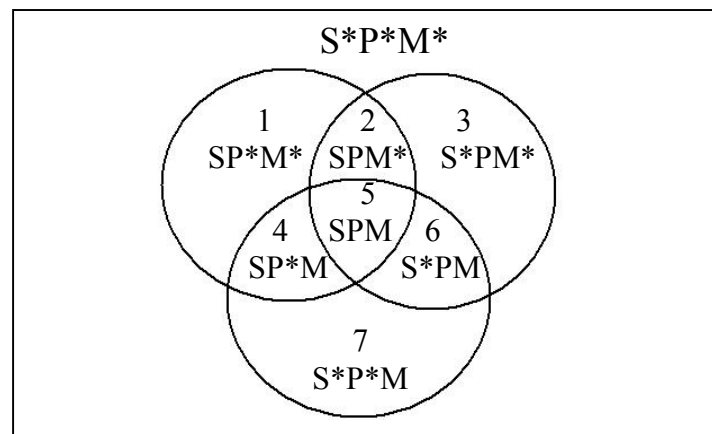

S, P, M refer to the subject, predicate, and middle terms respectively.

S*, P*, and M* refer to the compliments of S, P, and R respectively. The eight different classes defined by the three-circle Venn are:

1. SP^*M^* = those S which are neither P nor M.
2. SPM^* = those S which are P but not M.
3. S^*PM^* = those P which are neither S nor M.
4. SP^*M = those M which are S but not P.
5. SPM = those S which are both P and M.
6. S^*PM = those P which are M but not S.
7. S^*P^*M = those M which are neither S nor P.
8. $S^*P^*M^*$ = those that are neither S nor P nor M.

Exercise: name individuals in the above eight classes where:

- S = Americans, British, Asian, Hispanic
- P = singers athletes, scientists, politicians
- M = females, males

Let us now practice diagramming premises into the three-circle Venn diagram. The diagram for the universal premise All M is P is:

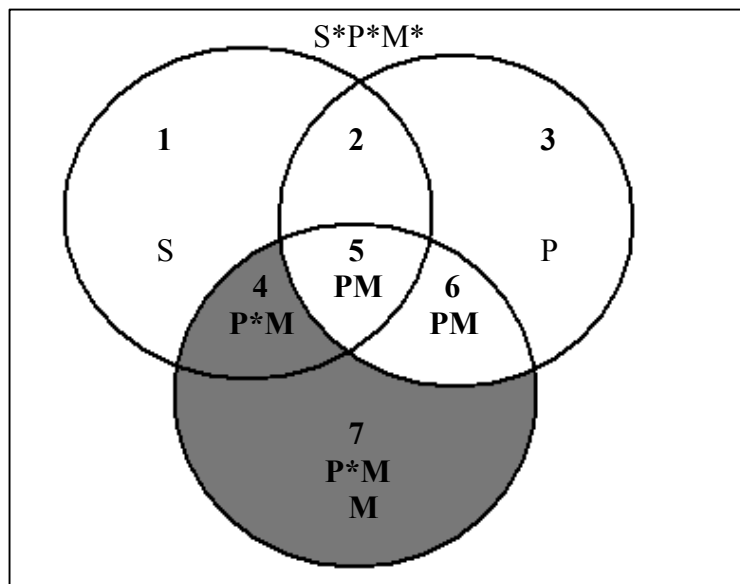

Figure 3.36

Notice that there are four sections of the circle M. Sections 5 and 6 are M which are P, while sections 4 and 7 are M which are not P. We must shade in sections 4 and 7 to show that all M are P. In other words, "M outside P is empty", and is symbolized as $MP^* = \emptyset$.

Let us next diagram a particular premise: "Some S is M."

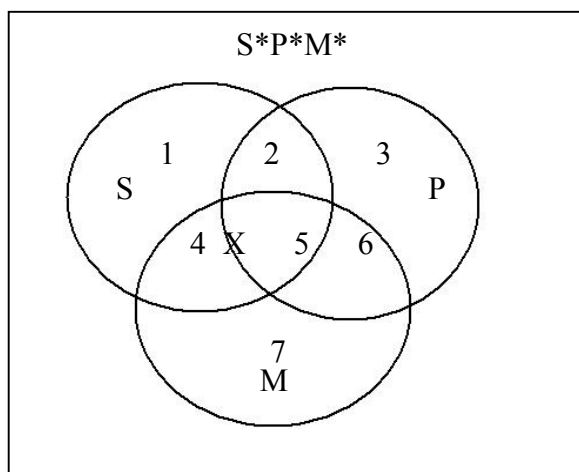

Figure 3.37

Observe in Figure 1 that SM pertains to both sections 4 and 5. Section 4 is in SM which, however, is not a P, while section 5 is an SM which is also a P. The statement, “Some S is M” does not specify which section is meant; hence, we need to include both sections and we do so by putting an X on the line dividing them. Thus, “Some S is M” means that SM is not empty.

When diagramming premises, remember to equate empty with shaded in areas, and not empty with an x. Remember, also, when you translate that “All M is P” means, M outside P is empty; “No M is P” means M inside P is empty; and “Some S is not M” means S outside M is not empty.

We are now ready to diagram the major and minor premises of a syllogism and then examine whether their combination produces the diagram for the conclusion. Let us begin with the following syllogism:

All S is M. / All M is P. // All S is P.

In standard form this would be

All M is P. / All S is M. // All S is P

Giving us the mood and figure AAA – 1.

We begin by diagramming the premises:

All M is P (Major Premise) – shade 4 & 7

All S is M (Minor Premise) – shade 1 & 2

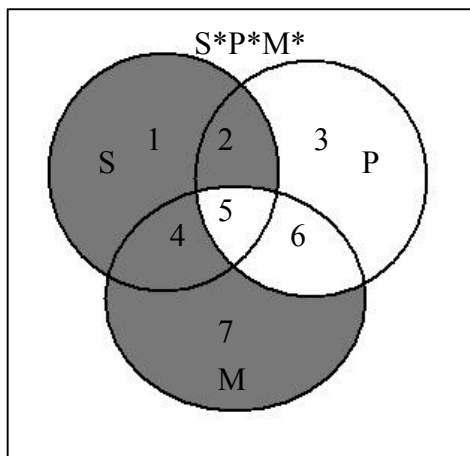

Figure 3.38

All S is P (Conclusion) – 1 & 4 shaded

By combining the diagrams of the two premises, the diagram of the conclusion follows necessarily. There is no member of S that is outside P, since areas 1 and 4 are shaded. Therefore we conclude that "All S is P." follows from the premises cited.

Let us determine whether the diagram of the conclusion is contained in the combined diagrams of the premises for the following syllogism:

No P is M. – shade 5 & 6

All S is M. – shade 1 & 2

No S is P. – 2 & 5 shaded

Combining the diagrams for the premises produces the diagram of the conclusion.

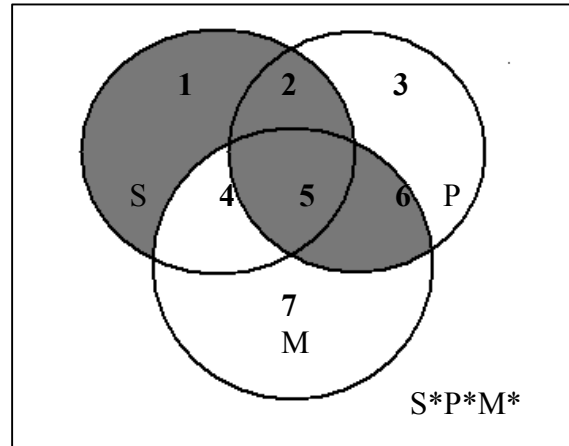

Figure 3.39

So far we have diagrammed universal premises. Let us now test a syllogism with one universal premise and one particular premise:

All M is P –shade 4 & 7

Some M is S – x in 4 or 5

Some S is P – x in 2 or 5

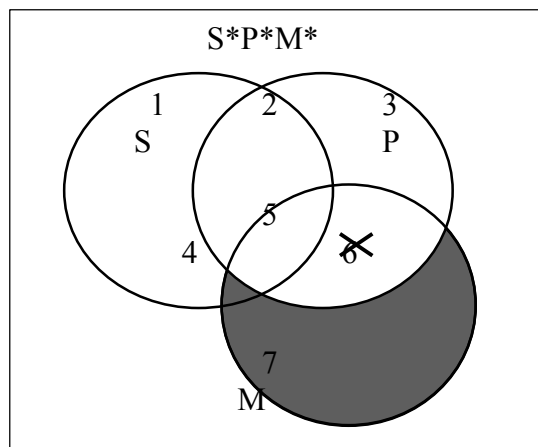

Figure 3.40

We always diagram the universal premise first . This shows us that area 4 has been shaded out, meaning that it is empty. The second premise, Some M is S, implies that x is in 4 or 5. But since 4 is empty, the x must be in 5. By combining the diagrams for the premises, the diagram for the conclusion is automatically produced. Therefore, the syllogism is valid.

A syllogism involving the insertion of an x is the following:

- All P is M shade 2 and 3
- Some M is not S x between 6 and 7
- Some S is not P x in 1 or 4

As always, we diagram the universal premise first :

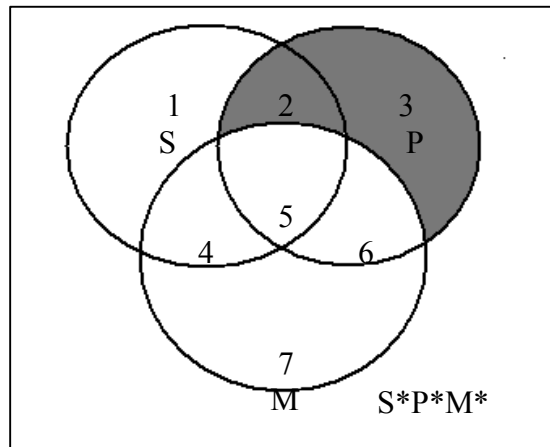

Figure 3.41

Next we diagram the minor premise, "Some M is not S." Recall that this statement means that the intersection of S^*M is not empty. But S^*M has two areas: 6 and 7. We place an \underline{x} on the line between them in order to indicate that it is in either 6 or 7. Thus, we have:

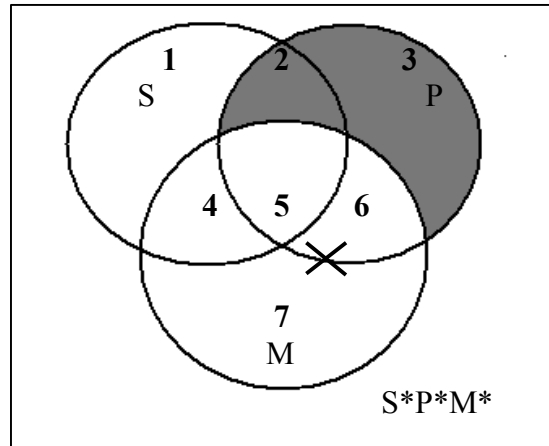

Figure 3.42

Looking at the completed diagram, we see that the conclusion, "Some S is not P" is not contained in the premises as diagrammed, for there is no x in area 1 or 4.

3.G.1. Exercises: Determine the validity of the following syllogistic forms by means of the Venn diagrams.

- | | | |
|----------|-----------|-----------|
| 1. AII-2 | 6. OAO-4 | 11. AOO-2 |
| 2. AAA-3 | 7. OEO-4 | 12. IEO-1 |
| 3. IAI-3 | 8. EAE-2 | 13. OAO-3 |
| 4. EAO-1 | 9. IAA-3 | 14. EAO-4 |
| 5. AAA-1 | 10. EEE-1 | 15. IAI-2 |

H. Existential Import

In section D of chapter 2 Venn diagrams were introduced in such a way that the Venn diagram for the A and E propositions did not contain an x. This means that the truth of : “All S is P” does not necessarily lead to the truth of “Some S is P”. One important reason for this is the fact that there are many true propositions that do not presuppose the existence of members of their subject class. An example is the following: "All mermaids are half-fish". This proposition does not assert that there are mermaids which have the property of being half-fish. Rather, it asserts that if they are mermaids then they are half-fish. And this is diagrammed without including within it the diagram for “Some mermaids are half-fish". Thus, to infer the truth of “Some mermaids are half-fish” from the truth of “All mermaids are half-fish” is an invalid inference. In our discussion of the rules method of testing validity, this was called the existential fallacy (Rule 5): “All S are P” can be true without assuming there are any A's; but if "Some S are P” is assumed true, then we are committed to believing that there exists at least one member of S, and that it is also a member of P.

This is a very important feature of language, for it allows us to make statements such as “All people caught cheating on the test are people who will be expelled from the College.” without assuming that some one is caught cheating on the test. On the other hand, many general statements are descriptive of plants, animals, people, and things that do actually exist. We say that an A or E proposition has **existential import** if the subject class of the proposition contains at least one actual individual. If this assumption is made, then it is valid to infer a particular proposition from its subaltern universal, as was done in the traditional square of opposition. Let us call a universal propositions that do not assume the existence of members of their subject class a **hypothetical universal**; and let us call a universal proposition that does assume the existence of members of its subject class an **existential universal**. The difference between them maybe shown by means of their Venn diagrams:

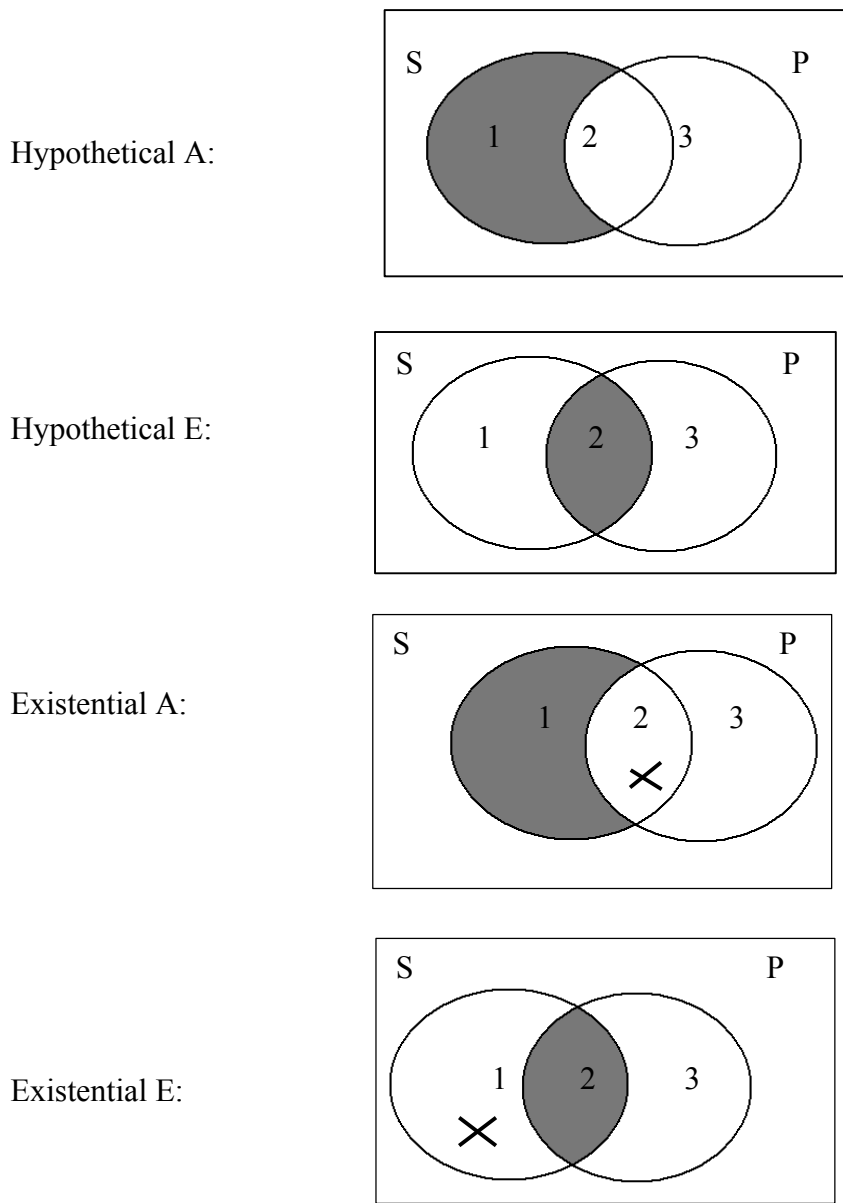

Figure 3.47

These diagrams clearly show that the truth of “Some S is P” can be inferred from “All S and P” and the truth of “Some S are not P” can be inferred from “No S are P”. The existential fallacy does not hold when we assume that the A and E propositions have existential import.

Let us now extend our use of existential A and E propositions in evaluating categorical syllogisms by considering the syllogistic form AAI-3:

All M are P shade 4 & 7, x in 5 or 6

All M are S shade 6 & 7, x in 4 or 5

Some S are P x in 2 or 5

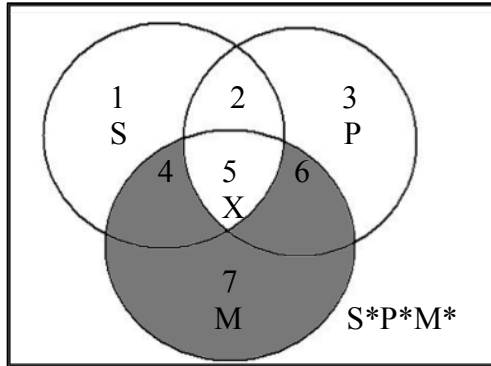

Figure 3.48

In diagramming the premises, we must do all of the shading first before we place the x so that we do not mistakenly place it in an area that is empty (shaded). Had we not done this, we could have mistakenly placed the x on the line that divides areas 5 and 6. But the diagram of the minor premise shows that area 6 is empty. Therefore the correct place for the x is in area 5. The x here tells us that the conclusion "Some S is P" is contained in the premises. Hence, the argument form AAI-3 is valid.

Let us next diagram the argument form EAO-3:

No M are P shade in 5 & 6, x in 4 or 7
All M are S shade in 6 & 7, x in 4 or 5
Some S are not P x in 4

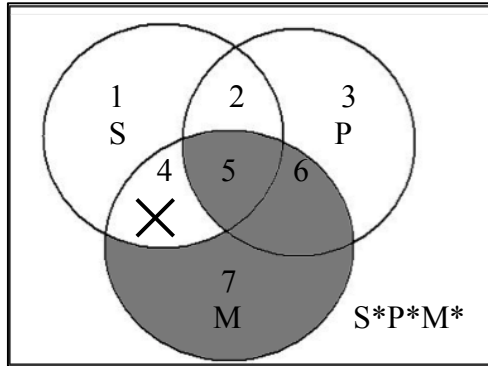

Figure 3.49

Since there is an x in area 4, the diagram for the conclusion is contained in the diagram of the combined premises. Therefore the argument form EAO-3 is valid.

Finally, let us diagram an invalid argument form: AAI-2

All P are M shade 2 & 3, x in 5 or 6
All S are M shade 1 & 2
Some S are P x in 5

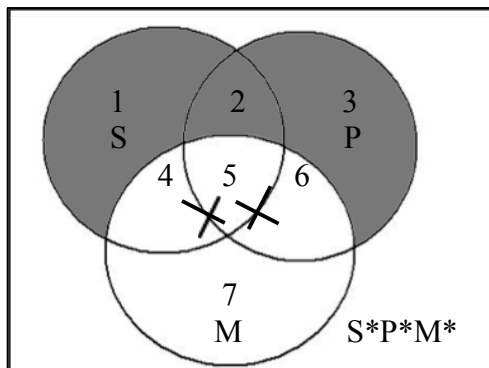

Figure 3.50

Note that while there might be an x in area 5, this is not necessarily so. Therefore the diagram of the conclusion is not necessarily contained within the diagram of the combined premises. Hence, the argument form, AAI-2 is invalid.

3.H.1 Exercises: Determine the validity of the following argument forms by means of Venn diagrams that incorporate the existential assumption:

- | | | | |
|-----------|-----------|-----------|-----------|
| 1. EIO-4 | 2. OAO-3 | 3. AEE-1 | 4. EIO-2 |
| 5. AOO-4 | 6. IAI-4 | 7. EAE-3 | 8. OAO-2 |
| 9. AOO-1 | 10. EIO-3 | 11. EIO-1 | 12. IAI-1 |
| 13. AOO-3 | 14. OAO-4 | 15. EAE-1 | |

3.H.2. Exercises: Put each of the following syllogisms into standard form, give its mood and figure, and test its validity by means of a Venn Diagram:

1. Some novelists are reformers, hence some Marxist are novelists, since all Marxists are reformers.
2. Some animals are not four-legged creatures for no four-legged creatures are birds and all birds are animals.
3. Some persons are not jobless individuals, but all welfare recipients are jobless individuals; it follows that some persons are not welfare recipients.
4. Some football watchers are fanatics, so some people are fanatics, since all football watchers are people.
5. All planes are fliers; therefore, no fliers are horses since no horses are planes.

6. No faint-hearted individuals were pioneers, for all faint-hearted individuals are adventure-less persons and no pioneers were adventure-less persons.
7. No aliens are citizens and all aliens are foreign-born persons, consequently, no citizens are foreign-born persons.
8. Some people are not Americans, for some people are not immigrants and some immigrants are not Americans.
9. No economic system that favors the rich is a just one and all forms of capitalism are economic systems that favor the rich, therefore, no just systems are forms of capitalism.
10. No farmers are industrial workers because no farmers are factory workers and all factory workers are industrial workers.

I. Enthymemes: How to Supply Unexpressed Premises and Conclusions

Now that we have studied the science and the art of determining valid categorical syllogisms, one might justly ask how practical is the knowledge we have learned. In everyday discourse, we do not hear people arguing by reciting syllogisms. How, then, can we determine whether these arguments are valid or not? For example, someone might say, "Okyere can become president of the United States because she was born in America". How can we test the validity of this type of argument?

An argument that is stated incompletely is called an enthymeme. The term is Greek and literally taken, it means "in the mind". Thus, one of the premises of such an argument is tacit, unexpressed, yet "in the mind" exerting an influence on the reasoning process. To determine the validity of an enthymeme, we need to supply the unexpressed premise.

First, we look for the conclusion. From it we know the subject and predicate terms which in turn tell us the major and minor premises. In the example above, the conclusion is “Okyere can become president of the United States.” This means that the minor premise is “Okyere is a native-born American.” The major premise is unexpressed, but we can supply it. We know that it contains the predicate term, “can become president of the United States,” and the middle term, “native-born American.” Thus we can form the major premise: All native-born Americans can become president of the United States. The argument, completely stated, is thus:

All native-born Americans can become president of the United States.

Okyere is a native-born American.

Okyere can become president of the United States.

We can then restate the argument into Aristotelian propositions and proceed to test the syllogism for validity.

The procedure for supplying the unexpressed premise is the same for enthymemes where the minor premise is unexpressed: “Okyere can become president because all native-born Americans can become president.”

If the conclusion is unexpressed, we must determine whether a valid conclusion can be drawn from the premises given. Suppose we have the following premises:

All M is P.

Some M is S.

Now, what valid conclusion can we draw from the premises given? Is it valid to conclude, “Some S is not P?” or “All S is P?” Knowledge of the rules will help us in identifying a valid conclusion. We know that the conclusion always contains the terms S and P, but from Rule 4 we know that the conclusion cannot be “Some S is not P” since a negative conclusion requires a negative premise. And the conclusion “All S is P” cannot

be drawn either because it would violate Rule 2, which states that no term can be distributed in the conclusion which is not distributed in the premise, which in this case is the S term. Thus the valid conclusion would have to be “Some S is P.”

3.I.1. Exercises: Enthymemes

Supply the unexpressed premise of the following arguments:

1. All dentists are college graduates so all members of the American Dental Association are college graduates.
2. I am a pessimist since I believe that there is more evil than good in the world.
3. Martin Luther King Jr. is a civil rights leader so he must be a supporter of freedom.
4. Premarital sex is immoral because any sex outside marriage is immoral.
5. No abortion is moral because abortion is the killing of an innocent person.
6. Any student who graduates from Farvard University is a well-educated person because anyone who graduates from a prestigious university is a well-educated person.
7. Mary knows math very well, so Mary must be a good math teacher.
8. All Wolves are Canines so all dogs are Canines.
9. Nuclear war kills massively and indiscriminately; therefore it is immoral.
10. No wealthy people are exploited; therefore no wealthy people support socialism.

11. According to Orthodox Jews, the West Bank belongs to Israel because Judea and Samaria belong to Israel.

12. Romney is for the rich because he favors tax cuts.

3.I.2. Exercises: Drawing Conclusions from Premises

Draw a valid conclusion from the following premises:

1. All good orators are fluent speakers.
Some preachers are good orators.

2. No vegetarian is a meat-eater.
Some vegetarians are men.

3. All geniuses are intelligent people.
Some physicists are geniuses.

4. No lady is a crude person.
Some women are crude persons.

5. All victims of economic injustice are members of oppressed groups.
All poor people are victims of economic injustice.

6. No adult movies are films for children.

Some movies are adult movies.

7. All supporters of democracy are lovers of freedom.

No dictators are lovers of freedom.

8. All killing of innocent persons is murder.

All abortions are killing of innocent persons.

9. No publishers of obscene and lewd magazines are decent and responsible citizens.

Some prosperous individuals are publishers of obscene and lewd magazines.

10. No person who pays federal income tax should be denied voting representation in Congress.

All residents of the District of Columbia pay federal income taxes.

11. All great athletes are cool under pressure.

Tiger Woods is a great athlete.

12. No Democrats are Republicans.

Abraham Lincoln was a Republican.

13. All liberals are advocates of national health insurance.

Senator John Edwards is a liberal.

14. No thoroughbred is a slow runner.

Seattle Slew is a thoroughbred.

15. All Black people are humans.

All Congolese are Black people.

3.I. 3. Exercises: For each of the following, supply the missing premise or conclusion that produces the strongest argument.

1. All A are B and all B are C.

2. All A are B because all B are C.

3. All A are B and all C are B.

4. All A are B because all C are B.

5. All A are B and all C are A.

6. All A are B because all C are A.

7. All A are B and some B are C.

8. All A are B because some B are C.

9. All A are B and some B are not C.

10. All A are B because some B are not C.

11. All A are B and some A are C.

12. All A are B because some A are C.

13. All A are B and some A are not C.

14. All A are B because some A are not C.

15. All A are B and No B are C.

16. All A are B because No B are C.

17. All A are B and No A are C.

18. All A are B because No A are C.

19. All A are B and some C are not A.

20. All A are B because some C are not A.

CHAPTER 4: TRUTH-FUNCTIONAL LOGIC

A. THE PROPOSITIONAL CALCULUS

Consider the following two-premise deductive arguments:

	Argument	Argument Form
(a)	Today is Wednesday or today is Thursday. <u>Today is not Thursday</u> Therefore, today is Wednesday.	A or B <u>not-B</u> A
(b)	If the gas tank is empty, then the car will not start. <u>The gas tank is empty.</u> Therefore, the car will not start.	If C then not-D <u>C</u> not-D

Now, these two examples embody two common argument forms. It will be the purpose of this chapter to develop a system of logic by means of which we can evaluate such arguments. This system of logic is called Truth-Functional or modern Logic. In truth-functional logic we begin with atomic or simple propositions as our building blocks, from which we construct more complex propositions and arguments. The **propositional calculus** provides us with techniques for calculating the truth or falsity of a complex proposition based on the truth or falsity of the simple propositions from which it is constructed. These techniques also provide us with a means of calculating whether an argument is valid or invalid.

I. Atomic (simple) Propositions

In the **propositional calculus** atomic or simple propositions are used to build compound propositions of increasingly high levels of complexity. The truth value of a compound can then be calculated from the truth values of its simple propositions. The **predicate calculus** provides us with a way of reconstructing the categorical propositions of traditional Aristotelian logic so that they can also be represented in modern truth-functional terms.

Individuals and Properties:

I. Constants

In truth-functional logic, we specify a universe of discourse by specifying the individuals that exist in that universe, and the properties those individuals may have. The names of individuals in our universe of discourse are abbreviated using lower case alphabets a, b, c, ... w. The names for the properties possessed by these individuals are abbreviated using upper case alphabets A, B, C, ... Z. For example, let j designate the individual John, and W designate the property of being wet. Then

$$Wx = x \text{ is wet} \quad \text{and} \quad Wj = \text{John is wet.}$$

And if we let d designate Debbie and A designate the property of being asleep, then

$$Ax = x \text{ is asleep} \quad \text{and} \quad Ad = \text{Debbie is asleep.}$$

If the names “John” and “Debbie” refer to actual individuals, then the propositions symbolized as Wj , Wd , Ad , and Aj are each actually either true or false. The individuals designated by j and d remain constant, no matter what property either is alleged to have. Likewise, the properties designated by W and A remain constant, no matter what individual is alleged to possess those

properties. Once a name has been assigned to a particular individual or property within a given discourse, it does not change.

II. Variables

The propositional form Wx attributes the property of being wet to an individual, x , where x could refer to any of the individuals in our universe of discourse. x is an **individual variable**, and Wx is a propositional form that becomes an actual proposition when x is replaced by the (abbreviated) name of an actual individual. Individual variables are place-holders for the names of individuals. The lower case alphabets x , y , and z are typically used as individual variables. A propositional form is neither true nor false, but it becomes true or false when its **individual variables** are replaced by **individual constants**.

In a similar fashion, every proposition that attributes a property to a particular individual, j , has the propositional form Φj (read “phi of j ” or “ j has the property Φ ; Φ is the Greek alphabet pronounced “phi”). Greek alphabets are used as place holders for properties that individuals may have, and are called **predicate variables**. Thus, Φj is a propositional form that becomes an actual proposition when Φ is replaced by the name of an actual property (e.g. W or A), which is then either truly or falsely attributed to John.

In the examples used so far, some individual, x , is alleged to have some property, Φ . When a property can be attributed to a single individual, it is called a monadic or **one-place predicate**. Thus, Wd can be true independently of whether any other individual in our universe of discourse is wet. The following examples of one-place predicates are designated by subscripted alphabets. In this way, an infinite number of predicates can be generated and combined with the names of individuals to produce statements that are either true or false.

$A_1x = x$ is a Republican	$B_1x = x$ is a human
$A_2x = x$ is a Democrat	$B_2x = x$ is a college professor
$A_3x = x$ is an American.	$B_3x = x$ is a woman
$A_4x = x$ is the USA president	$B_4x = x$ is a man
$A_5x = x$ is a Christian	$B_5x = x$ is a musician
$A_6x = x$ is hardworking.	$B_6x = x$ is a Muslim
$A_7x = x$ is asleep	$B_7x = x$ is a Buddhist
$A_8x = x$ is a Hindu	$B_8x = x$ is wealthy
$A_9x = x$ is an engineer	$B_9x = x$ is a soccer player
$A_{10}x = x$ is Jewish	$B_{10}x = x$ is a basketball player

4.I.1. Exercise: Using lower case letters to designate the names of actual individuals, construct one true and one false proposition for each of the above predicates.

III. Relational Properties

But not all properties can meaningfully be attributed to just a single individual. Many properties point to a relationship between two or more individuals rather than to an attribute of a single individual. For example, if M designates the property of being married, then Md (Debbie is married) is either true or false. But being married does not refer to the property of a single individual, but designates a relationship between (at least two) individuals. Thus, construing the property of being married as if it were like the property of being wet is misleading.

While Wd can be true independently of whether any other individual is wet, Md cannot be true independently of whether any other individual is married. A statement of the form Mx is really short for Mxy , which reads x is married to y . Thus, if Md is true, then there must be some other individual, e , such that Mde . Being married is not a one-place predicate, but (in a monogamous universe) a two place predicate. A two place predicate designates a relationship between two individuals, rather than a property of one individual. Following are some examples of statement forms with **two-place predicates**:

$Nxy = x$ is next to y $Wxy = x$ weighs more than y
 $Txy = x$ is playing tennis with y $Exy = x$ is an employee of y
 $Mxy = x$ is the mother of y $Fxy = x$ is the father of y

Note that while it is true that (if Nxy then Nyx), it is false that (if Wxy then Wyx). Some two-place predicates are commutative, but many are not. Following are some examples of two-place predicates that are often expressed as if they were one-place predicates:

	One Place	What is meant	Two Place
x is in love	Lx	x is in love with y .	Lxy
x is angry	Ax	x is angry at y	Axy
x is a parent.	Px	x is a parent of y .	Pxy
x is strong.	Sx	x is stronger than y .	Sxy
x is a veteran	Vx	x is a veteran of war y	Vxy
x is reading	Rxy	x is reading y	Rxy
x is eating	Ex	x is eating y	Exy

Some properties refer to relationships between three individuals. Thus, ' x is between y and z ' = $Bxyz$. Likewise, ' x is a child' is shorthand for ' x is a child of y and z ' or $Cxyz$.

‘Between’ and ‘is a child’ are three-place predicates. Some predicates actually refer to a relationship between four individuals, yet appear to be about one individual. Thus, ‘x is playing tennis doubles’ (or TDx) may seem to be saying something only about x. But it is shorthand for ‘x is playing tennis doubles with y, z and w’ (or TDxyzw). We symbolize 1-place, 2-place, 3-place, and n-place predicates as Ax , Bxy , $Cxyz$, $Dwxyz$, ... These statement forms become actual statements that are true or false when each variable is replaced by a constant.

4.I.2. Exercises:

$Cxyz =$ “x is between y and z.”

Let a, b, and c be distinct points on a straight line.

Answer the following:

- 1.) C is a ____-place predicate.
- 2.) If $Cabc$ is true, then $Cbca$ must be ____ (True/False)
- 3.) If $Cabc$ is true, then $Cacb$ must be ____ (True/False)

4.I.3. Exercises:

$Mxy =$ “x is married to y.”

$Pxyz =$ “x and y are the parents of z.”

Bonnie = b, Joe = j, and Ted = t.

Answer the following:

- 1.) M is a ____-place predicate.
- 2.) P is a ____-place predicate.

Symbolize each of the following statements:

- 3.) Bonnie is married to Joe. _____
- 4.) Ted and Joe are the parents of Bonnie. _____
- 5.) Ted is married to Joe. _____
- 6.) Ted is married to Bonnie. _____
- 7.) Joe and Bonnie are the parents of Ted. _____

II. Compound Propositions

A compound proposition is one that contains other propositions as component parts. For example, the proposition, “Today is Wednesday or today is Thursday” contains two component propositions: “Today is Wednesday” and “Today is Thursday.” Similarly, the proposition, “If the gas tank is empty, then the car will not start” is a compound proposition that contains the two component propositions: “The gas tank is empty,” *and* “The car will not start.” Propositions that do not contain other propositions are called simple propositions.

II. Truth-functional Compound Propositions

The kinds of compound propositions we are concerned with are called truth-functional compound propositions. A truth-functional compound proposition is a proposition whose truth or falsity (that is, truth-value) is a function of the truth or falsity of its component propositions. Appropriately, the logic that deals with truth-functional compound propositions is called truth-functional logic.

III. Kinds of Truth-functional Compound Propositions

Truth-functional compound propositions are conventionally classified into five kinds:

1. **Negations:** The denial of a statement in English is usually made by inserting a “not” into the original statement. For example, the statement “John F. Kennedy was killed by the Mafia” is negated by inserting “not” to produce “John F. Kennedy was not killed by the Mafia.” One can also express a negation in English by such alternative phrases as “it is false that” or “it is not the case that.”
2. **Conjunctions:** When two statements are joined by the word “and” between them, it is called a conjunction. The component statements are called conjuncts. Thus, the compound statement,

“Mr. Obama is the President of the United States and Mr. Biden is his Vice-President” is a conjunction.

Conjunctions can be expressed in alternative ways in ordinary English. To illustrate, the standard conjunction “Peter went to school and Paul stayed home” can be expressed in non-standard forms as:

Peter went to school, while Paul stayed home.

Peter went to school, but Paul stayed home.

Peter went to school, even though Paul stayed home.

Although Peter went to school, Paul stayed home.

Although Paul stayed home, Peter went to school.

Peter went to school; however, Paul stayed home.

There is no logical limit to the number of components in a conjunction. It could have more than two, as in “Mary baked a cake and Susan went shopping while Tina slept and John drove to work.”

3. **Disjunctions:** A compound statement in which two or more components are connected by the word “or” is called a disjunction. The component statements so combined are called disjuncts (or alternatives). Example: “We economize on the use of energy or we will have run-away inflation.” (We will later make a distinction between the ‘inclusive’ and ‘exclusive’ senses of the word “or”.)

In ordinary English, one and the same disjunction can be expressed in alternative ways. For example, a disjunction that has the same subject term as “Jones is the employer or Jones is the owner” might be equally well expressed as “Jones is the employer or the owner.” The second expression avoids the repetition of the common part of the disjunction which, in this case, is the subject term Jones. The same procedure is followed in a disjunction where the predicate term is the same. Thus, “Brown is innocent or Smith is innocent” can be expressed as “Brown or Smith is innocent.” The negation of a disjunction in English is often expressed by the phrase

"neither...nor." Thus, the negation of the disjunction, "Jones or Smith is the best player on the team" is expressed as "Neither Jones nor Smith is the best player on the team."

4. **Conditionals:** When two statements are joined by placing the word "if" before the first statement and the word "then" before the second statement, the compound statement resulting is called a conditional (also called an implication or an implicative statement or a hypothetical).

Example: "If property taxes continue to rise, then retired people cannot afford to keep their homes." The statement following "if" is called the **antecedent** (also called the implicans or protasis) and the statement following "then" is called the **consequent** (also called the implicate or apodosis). Examples of conditional statements in English that we will consider are:

(1) If Mary gets her car repaired, then she will take a trip.
 antecedent consequent

(2) If the snow melts in the mountains, then there will be flooding in the valley.
 antecedent consequent

(3) If Jones is married, then she has a spouse.
 antecedent consequent

In ordinary English, the standard-form conditional "If Smith is President of the United States, then he is over thirty-five" can be expressed in various ways such as:

If Smith is president of the U.S., she is over thirty-five.

Smith is over thirty-five if she is president of the U.S.

Smith is over thirty-five, provided she is president of the U.S.

On condition that Smith is president of the U.S., then she is over thirty-five.

Smith is over thirty-five in the case that she is president of the U.S.

Smith is president of the U.S. only if she is over thirty-five.

Smith is not president of the U. S. unless she is over thirty-five.

Unless she is over thirty-five, Smith is not president of the U.S.

5. Biconditionals: A compound statement in which the component statements are joined by the phrase, “if and only if” is called a biconditional. The components of a biconditional are called the right-hand component and the left-hand component.

Examples:

D. C. residents can have voting rights if and only if a majority of the states ratify the voting rights amendment.

Today is Friday if and only if yesterday was Thursday.

John is neither tall nor handsome if and only if John is not tall and John is not handsome.

IV. Statement Connectives

We can identify the kinds of compound propositions enumerated above by the kinds of statement connectives used to join the simple propositions into compound ones. Statement connectives combine simple propositions into compound propositions. The five connectives are:

1. Negation: not, it is false that, it is not the case that.
2. Conjunction: and, but, while, likewise, etc.
3. Disjunction: either...or, or
4. Conditional: if...then, only if, unless, provided, etc.
5. Biconditional: if and only if.

V. Translation from Ordinary Language to Truth Functional Propositional Forms

If truth functional logic is to be useful, we must be able to translate statements and arguments expressed in ordinary language into truth functional propositional forms. Having done so, truth functional logic provides us with techniques by means of which we may calculate the truth of complex propositions and the validity (or invalidity) of complicated arguments. That is why truth functional logic is also called the propositional calculus. A digital computer is itself only a logic machine in which the operations of truth functional logic are performed by electrical circuits. Computers illustrate how systems of logic make it possible for us to organize large amounts of information and process it at speeds beyond ordinary conception.

When statements are translated into the propositional forms of truth functional logic, component simple propositions must be fully expressed. To illustrate, the statement

(A₁) Mary can dance and sing.

should be rephrased as the compound conjunctive proposition

(A₂) Mary can dance and Mary can sing.

In (A₂) it is clear that the connective “and” joins two simple propositions, so that the original statement (A₁) has the propositional form.

(A) p and q

But not all compound propositions have simple propositions as their only constituents. Often, our statements involve diverse levels of compound propositions joined to other compound propositions by the truth functional connectives. Thus, the statement:

(B₁) Jones is neither poet nor philosopher if he can't appreciate jazz.

is a compound formed by joining two compound statements as follows:

(B₂) If Jones cannot appreciate jazz then Jones is not a poet and Jones is not a philosopher.

This helps make it clear that there are three simple propositions involved in the original statement:

<u>Simple Propositions</u>	Abbreviations	Variables
Jones can appreciate jazz	M	p
Jones is a poet	N	q
Jones is a philosopher	O	r

These simple propositions are compounded so that the negation of M is the antecedent clause of a conditional proposition while the consequent clause is the conjunction of the negation of N and the negation of O. Thus, B₂ has the following form:

B. If not-M then (not-N and not-O).

This example illustrates how complex statements often have compound propositions joined to other compound propositions. Thus, careful analysis is needed in order to isolate the simple propositions and show how they are operated on by the truth functional connectives to produce a correct translation of the original statement.

In order to facilitate extracting and combining simple propositions into compound propositions of different levels of complexity, the following distinctions between levels of propositions may prove useful:

Level 1 propositions - Simple propositions (e.g. p, q, r, s)

Level 2 propositions - Compound propositions formed by applying truth functional operations to level 1 propositions (e.g. not-p, p and q, p or q, if p then q, not-q).

Level 3 propositions - Compound propositions formed from lower level propositions, at least one of which is a level 2 proposition. (e.g. p and (q or r), if p then not-q).

Level 4 propositions - Compound propositions formed from lower level propositions, at least one of which is a level 3 proposition (e.g. if p then (not- p and not-q)).

Level 5 propositions - Compound propositions formed from lower level propositions, at least one of which is a level 4 proposition (e.g.. not-(if (not-p or q) then p).

Thus, all propositions with the form "If not-M then (not -N and not-O)" are level 4 conditional propositions, with a level 2 negative proposition as antecedent and a level 3 conjunctive proposition as consequent.

In truth functional logic, non-standard connectives must be translated into the standard connectives of truth functional logic. Thus, non-standard connectives such as "but," "while," "however," "even so," etc. are translated into the standard connective for the conjunction "and."

Likewise, phrases such as "It is not the case that..." and "It is false that..." are replaced by a standard indication of negation, "not-..." And non-standard connectives used to form statements of the form "p only if q," "q provided that p," "q, on condition that p," etc. are translated into the standard conditional form "if p then q."

Non-standard statement connectives may often require the use of more than one standard truth functional connective, as with non-standard connectives such as "p unless q" and "neither p nor q." Thus, "p unless q" translates into "If not-q then p." And "Neither p nor q" translates into "Not-(p or q)." While "if p then q" is a level 2 compound propositions, "p unless q" is a level 3 proposition. Likewise, while "p or q" is a level 2 proposition, "neither p nor q" is a level 3 proposition.

In Aristotelian logic, non-standard quantifiers such as "each," "every," "a few," and "many" are translated into the standard quantifiers "all" and "some" to form categorical propositions. In modern logic, we will see how "all" and "some" are, in turn, translated into the universal and existential quantifiers (\forall) and \exists .

4.A.1. Exercises:

For each of the following statements, specify its simple propositions and use T-F connectives to show how the simple propositions are combined:

1. Lewis and Clark are famous American explorers. _____
2. Muhammad Ali is either big or fast. _____
3. Unless Tom study, Tom will not pass the Logic course. _____
4. Neither Tom nor Mary was present at the wedding. not (p or q)
5. Mary is tired and hungry. _____
6. Either the butler or the maid is the guilty person. _____
7. Tom and Mary will attend the party on condition that it does not snow. _____
8. Father went to work, while Mother stayed home. _____
9. Tom will shoot himself if Tom is not careful. _____
10. Mary will stay with relatives or with friends if she visits NYC. _____
11. Tom will continue to gamble as long as he is winning. _____
12. Although Sen. Whurmond is old, he is physically fit. _____
13. Tom and Mary will reach their destination, provided they don't get lost. _____
14. The house for sale is beautiful but costly. _____
15. Mary will leave Tom only if Tom is not respectable. _____
16. Whenever gasoline burns, there is oxygen. _____

B. Symbolic Notation for Truth-Functional Statements.

Formal logic is concerned primarily with the structure of statements and arguments as they are characterized within a particular formal system. Connectives such as “not,” “but,” “while,” “and,” “or,” “unless,” etc., are used in ordinary English with many connotations and meanings that are not carried over into the system of truth-functional propositional logic. In order to avoid the nuances and ambiguities these words have in their ordinary usage, they are replaced by symbols that have precise rules determining how they are to be understood and used. Not only does the substitution of symbols for words help us to clarify statements, it also shortens the space and time needed to express long, complicated propositions.

Statements that are translated into the formal systems of truth-functional propositional logic have two elements that are symbolized: (1) the distinct simple propositions used in the statement; and (2) the connectives used to form compound statements from the simple propositions. We will now introduce rules for symbolizing these two elements.

B.I. Symbols for Logical Connectives:

1. Negation: “not” is symbolized by a curl or tilde (\sim).
2. Conjunction: “and” is symbolized by a dot (\bullet).
3. Disjunction: “or” is symbolized by a wedge (\vee).
4. Conditional: “if...then...” is symbolized by a horseshoe (\supset).
5. Biconditional: “if and only if” is symbolized by a triple bar (\equiv).

Observe that logical connectives keep the same meaning wherever they occur much like the mathematical operators ($-$, $+$, \times , \div).

Illustrating the use of the symbols we have:

\sim Jane is kind = It is not the case that Jane is kind.

Jane is kind \cdot Bob is honest = Jane is kind and Bob is honest.

Jane is kind \vee Bob is honest = Jane is kind or Bob is honest.

Jane is kind \supset Bob is honest = If Jane is kind, then Bob is honest.

Jane is kind \equiv Bob is honest = Jane is kind if and only if Bob is honest.

II. Symbols For Component Simple Propositions:

The introduction of symbols for simple propositions is a very important step. Symbols shift our attention away from the actual meaning of the simple propositions we use and allow us to focus instead on the kinds of relationships that exist between simple propositions. Thus, each of the following statements has the same form, though their emotional and cognitive significance varies greatly:

<u>Statement</u>	<u>Statement Form</u>
(a ₁) It is not raining unless there are clouds in the sky.	not-P unless C.
(a ₂) The Democrats will not win unless Black Americans turn out to vote.	not-D unless B.
(a ₃) The Democrats will not win unless Jewish Americans support them.	not-D unless J
(a ₄) Tom will not pass this course unless Tom studies.	not-P unless S.

(a₅) Today is not Tuesday unless yesterday was
Monday.

not-T unless M.

The abbreviated forms help us see that the general form for each of the above is:

(a₆) not-q unless p

And translation of the non-standard operator “unless” gives us:

(a₇) If not-p then not-q.

Thus, the symbolic form of each of the above examples is

(a) $\sim p \supset \sim q$

The form represents a kind of relationship between two propositions and is independent of what those propositions are about. To distinguish between simple and compound propositions, capital letters will be used to abbreviate simple propositions. Most often the letter will be derived from a key idea in the sentence itself. Thus, in the example, "Jane is kind," "Bob is honest," if we take the key ideas to be Jane and Bob, then we can use the capital letter J as an abbreviation of "Jane is kind" and B for "Bob is honest." We thus have: $J \bullet B$ as the abbreviation of the conjunction¹. Using these propositions as examples, we can illustrate the forms of the five kinds of truth-functional compound propositions as follows:

¹ We could have taken "kind" and "honest" to be the key ideas, in which case "Al is kind" would be abbreviated by K and "Bob is honest" by H. In general it makes little difference what letter we use to abbreviate a simple proposition so long as we use one and only one letter to represent one and only one proposition: wherever that proposition occurs that letter is substituted, and wherever the letter occurs, it stands for that proposition.

Concrete Statements:

Abbreviations

- | | |
|--|-------------------|
| 1. Negation: It is not the case that Jane is kind. | $\sim K_J$ |
| 2. Conjunction: Jane is kind and Bob is honest. | $K_J \cdot H_b$ |
| 3. Disjunction: Either Jane is kind or Bob is honest. | $K_J \vee H_b$ |
| 4. Conditional: If Jane is kind, then Bob is honest. | $K_J \supset H_b$ |
| 5. Biconditional: Jane is kind if and only if Bob is honest. | $K_J \equiv H_b$ |

B.II Propositional Schemata and Propositional Forms.

The abbreviations $A \supset B$, $C \supset D$, $E \supset F$, etc., which stand for concrete conditional propositions have a common logical form which can be schematized as $\underline{\quad} \supset \underline{\quad}$. Instead of using blanks to stand for any component proposition that may be used in such schemata, we will use small letters from the middle to the end of the alphabet, starting with p, then q, r, s, etc. Thus, the propositional form of any conditional sentence becomes $p \supset q$. Let us illustrate the symbolic notation of conditional statements:

Concrete Statement

Statement Form

Propositional Form

- | | | |
|---|-------------------|---------------|
| 1. If Jane is <u>kind</u> , then Bob is <u>honest</u> . | $K_J \supset H_b$ | $p \supset q$ |
| 2. If it rains <u>on the lawn</u> , the <u>lawn</u> gets wet. | $L_r \supset L_w$ | $p \supset q$ |

Summary of Compound Statement Forms:

- (1) Negation: $\sim p$, $\sim q$, etc.
- (2) Conjunction: $p \cdot q$
- (3) Disjunction: $p \vee q$

(4) Conditional: $p \supset q$

(5) Biconditional: $p \equiv q$

III. Logical Punctuation:

In both mathematics and logic, punctuation is necessary to make the meaning of symbolic expressions precise. In mathematics, the result of $(3 \times 2 + 4)$ is unclear until the constituent parts are properly grouped. If they are grouped as $((3 \times 2) + 4)$, then the result is 10; but when they are grouped as $(3 \times (2 + 4))$, we get 18. Thus, when compound sentences become constituent parts of more complicated compound statements, it is necessary to group the constituent parts correctly to avoid ambiguity with respect to their meaning and truth-value. The need for punctuation is illustrated by the following ambiguous sentence:

The dance will be on Saturday and John will have a date or John will stay at home.

This sentence has the ambiguous propositional form $p \bullet q \vee r$. One way to clear the ambiguity is by placing a comma after “date,” so that it reads:

The dance will be on Saturday and John will have a date, or he will stay at home.

This is symbolized as $(p \bullet q) \vee r$

Another way of clearing the ambiguity is to insert a comma after “Saturday”, so that it reads:

The dance will be on Saturday, and John will have a date or he will stay at home.

This sentence is symbolized as

$p \bullet (q \vee r)$

Clearly, the proposition symbolized by $(p \cdot q) \vee r$ is not identical in meaning to the proposition symbolized by $p \cdot (q \vee r)$.²

By using punctuation marks such as parentheses (), brackets [], and braces { }, it is possible to clearly state the alternative meanings of an ambiguous statement so as to determine which option is intended.

Again, compare the following punctuation: (1) $\sim(p \vee q)$; (2) $\sim p \vee q$. In (1), the negation sign operates on the compound statement, while in (2), it operates only on the simple proposition p . The convention is that where there is no punctuation, the negation sign should be understood as applying to the nearest component.

B.III. Logic Diagrams:

Another way of resolving the ambiguity involved in a statement like $(p \cdot q) \vee r$ is by means of logic diagrams. Logic diagrams provide a visual depiction of how simple propositions are operated on by logical operators to form compound propositions. Thus,



4.1

is the diagram showing how the proposition p is operated on to produce the compound proposition $\sim p$. Likewise, the diagram

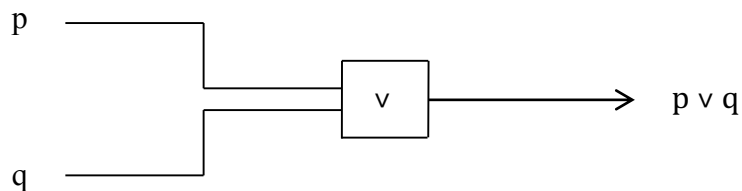

4.2

² When we do truth-tables we will see that when p is false and r is true, then $((p \cdot q) \vee r)$ will be true while $(p \cdot (q \vee r))$ will be false.

shows how the simple proposition p and the simple proposition q are acted on by the operator \vee to produce the compound proposition $p \vee q$. In a similar fashion, the diagram

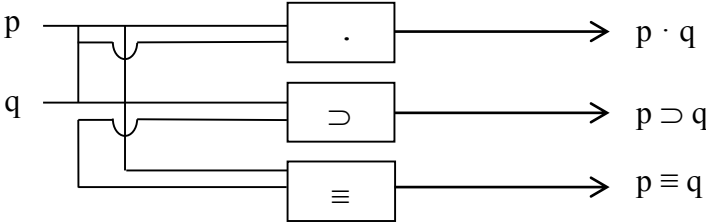

4.3

shows how the simple proposition p and the simple proposition q are operated on by the operators \cdot , \supset , and \equiv to produce the compound propositions indicated. We should note the difference between diagrams:

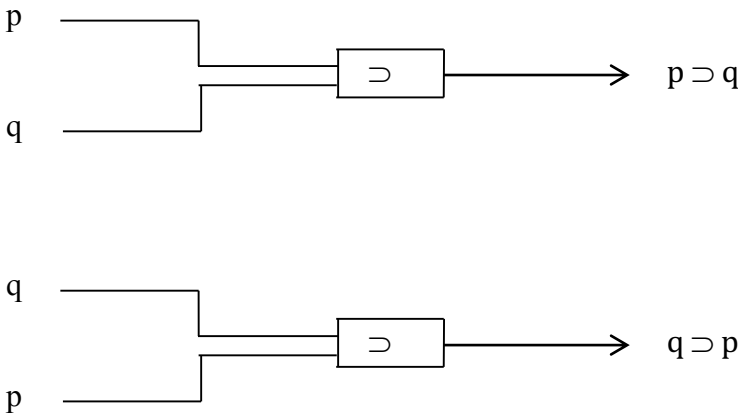

4.4

Logic diagrams serve much the same function as parentheses: they indicate the order in which simple propositions are compounded in order to form successive levels of compound propositions. The propositional form $(p \cdot q \vee r)$ is ambiguous because it does not tell us whether

p should be grouped with q and their compound grouped with r , or whether q should be grouped with r , and then their compound grouped with p . It is ambiguous between the following two propositional forms:

a. $(p \cdot q) \vee r$

b. $p \cdot (q \vee r)$

Their respective logic diagrams are as follows:

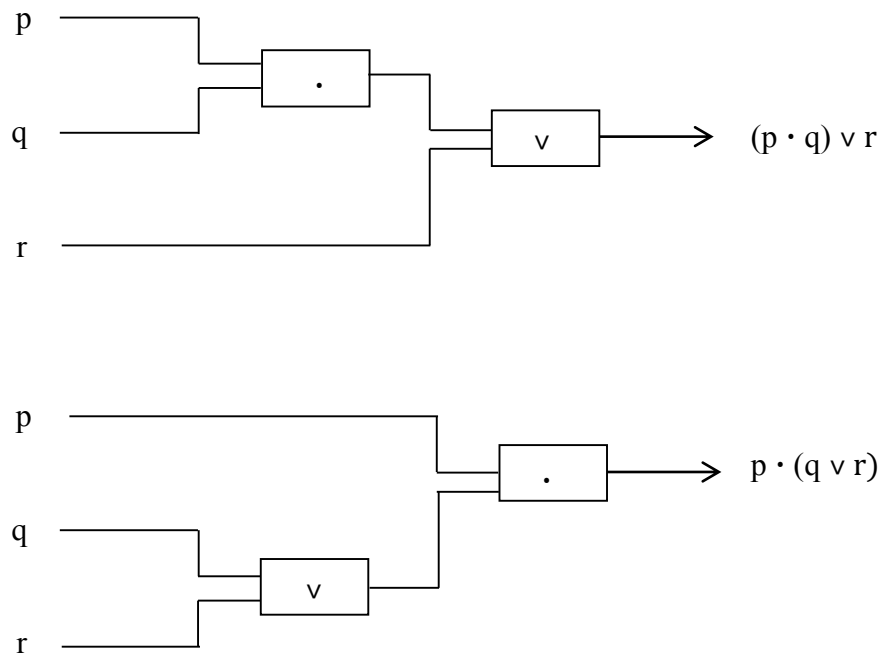

Figure 4.5

These diagrams are a graphic representation of the order in which the logical operators are to be applied so as to produce an unambiguous propositional form.

4.B. Exercises:

B.1 Write out the standard form translations of exercise A.1 using symbolic notation:

B.2 Translate the following statement forms into statements:

Let “A” abbreviate “It is autumn.”

Let “L” abbreviate “The leaves will fall.”

Let “C” abbreviate “It will get colder.”

1. $A \cdot C \cdot L$

2. $A \supset (C \cdot L)$

3. $\sim A \supset \sim L$

4. $L \equiv A$

5. $\sim (A \cdot L)$

6. $A \vee C$

7. $(C \cdot A) \supset L$

8. $(\sim C \vee \sim A) \supset L$

9. $(\sim A \vee \sim C) \cdot \sim L$

10. $A \equiv (C \cdot L)$

4.B.3. Exercises: Write out the logic diagrams for each of the propositional forms of Exercise 4.B.2.

4.B.4. Exercises:

Let:

Cxy = x cleans y's room.

Axy = x is angry with y

Ixy = x will take y for a treat

Mxy = x is the mother of y

f = Ms Flotmos

j = Jamie

Symbolize the following statements:

1. If Jamie cleans her room then Ms Flotmos will take her for a treat.

2. If Jamie does not clean her room then Mrs. Flotmos will not take her for a treat.

3. If Ms Flotmos is angry with Jamie then Jamie will not clean her room.

4. If Jamie cleans her room then Ms Flotmos will not be angry with Jamie.

5. Ms Flotmos is Jamie's mother.

6. If Jamie is Ms Flotmos mother then Jamie will take her for a treat.

7. Jamie is not Ms. Flotmos' mother.

.B.5. Exercises: Abbreviate the following concrete statements using capital letters for underlined properties and small letters for individuals:

1. Jones' dish is a stew.
2. Jones' dish is not a stew.
3. Tom's dish is a stew and Mary's dish is a pudding.
4. Jones is intelligent or Smith is intelligent.
5. If Smith is in school, then he is being educated.
6. Tom is a physician if and only if Tom is a college graduate.
7. Jones is at school or Jones is at play.
8. John is a father if he has a child.
9. Smith is happy if Jones is happy.
10. Jones will neither love Mary nor hate her.
11. Kasui will buy both a house and a car.
12. Musharief will dance but not sing.
13. Mary will succeed on the condition that Mary works hard and has faith in herself.
14. Mary will dance or sing if Jones will play the piano.
15. A figure is a triangle if it has three sides but is a rectangle if it has four sides.
16. Mary is intelligent but aggressive and Jones is diligent but shy.
17. Well built houses are neither cheap nor available.
18. If Jones returns, then Tom will go and Mary will stay.
19. Jones returns and Mary goes, but Tom stays.
20. If inflation increases, then Mary will be unemployed.

4. C. ARGUMENTS USING COMPOUND PROPOSITIONS

C.I. Valid and Invalid Argument Forms.

Consider the following argument:

(1a) If it is raining outside then there are clouds in the sky.

It is raining outside. _____

There are clouds in the sky.

The form of this argument is:

(1) If p then q

p _____

q

This argument form is valid, which means, for any argument that has this form, if its premises are assumed true, then its conclusion must be accepted as true. This condition holds irrespective of the actual content of the component statements or of their actual truth-values. Thus, the following argument is also valid:

(1b) If Dallas is in California, then Paris is in Finland.

Dallas is in California _____

Paris is in Finland.

Of course we know that the premises of argument (1b) are false, and that is why we do not accept its conclusion as true. But if the premises of (1b) were accepted as true, then we would have to accept its conclusion as true. That is the meaning of a valid argument: it is impossible for the premises of a valid argument to be true and its conclusion false.

On the other hand, an invalid argument is one with an argument form such that both premises could be true, yet the conclusion false. Consider the following argument:

(2a) If Jones is guilty, then he should be punished.

Jones is not guilty. _____

Jones should not be punished.

Although the conclusion of this argument appears to follow “logically” from its premises (2a) is nonetheless an invalid argument, which means that the truth of the premises of that argument does not lead necessarily to the truth of its conclusion.

To see this, we must first extract the form of (2a) which is

(2) If p then q

$\sim p$
 $\sim q$

The following argument has the same form:

(2b) If it is raining outside, then there are clouds in the sky.

It is not raining outside.

There are no clouds in the sky.

Providing an analogous argument where both premises of (2b) are true, yet the conclusion is false is a **refutation**. It proves that (2) is an invalid argument form and that (2a) is an invalid argument. Refutations prove that a particular claim does not necessarily follow from the premises given.

Beyond constructing refutations by analogy, propositional logic provides us with other procedures for determining when an argument expressed in truth-functional form is valid or invalid. In what follows we will discuss two such methods: the Rules Method, the Truth-Table Method, and the Natural Deduction Method. First we will present the rules for determining the validity of disjunctive and conditional syllogisms.

C.II. Disjunctive Syllogisms.

A disjunctive syllogism is an argument in which the first premise is a disjunction. There are two types of disjunctions: the exclusive and the inclusive. An example of an exclusive disjunction is “Jones is 20 years old or Jones is 21 years old.” Here, Jones is one or the other age but not both ages at once. With an exclusive disjunction, the truth of one disjunct excludes the possibility that the other disjunct is true. In other words, both disjuncts cannot both be true at the same time.

An example of the inclusive disjunction is “The dog ran away or the dog was run over by a car.” This compound statement is true if either disjunct is true or if both disjuncts are true. Thus, the dog ran away or the dog was run over by a car or possibly both. An inclusive disjunction is false only if both disjuncts are false. The sense of “or” that we shall use to represent disjunctive statements is the inclusive sense.

Let us now consider disjunctive arguments in which the first premise is an inclusive disjunction. If we assume the first premise to be true, it means that one or the other or both disjuncts are true. But if we know that one of the disjuncts is false, we can validly infer that the other must be true. This inference is illustrated in the following valid argument form:

$p \vee q$ (first premise)
 $\sim p$ (second premise)
 q (conclusion)

The other valid argument form for a disjunctive syllogism is:

$p \vee q$ (first premise)
 $\sim q$ (second premise)
 p (conclusion)

Again, if the first and second premises are assumed to be true, then the truth of the conclusion necessarily follows. If the first premise is true, then p or q is true or possibly both. And if the second premise is true, then q is false. It follows that p must be true.

The following examples illustrate these two valid argument forms:

Jones is friendly or Jones is deceptive.
Jones is not friendly.
Therefore, Jones is deceptive.

This example has the valid argument form:

$p \vee q$
 $\sim p$
 q

The other example is:

Jones is friendly or Jones is deceptive.

Jones is not deceptive.

Therefore, Jones is friendly.

This example has the valid argument form:

$p \vee q$

$\sim q$

p

Some concrete arguments exhibiting invalid argument forms are:

(1) Tom will sing or Tom will dance. $p \vee q$

Tom will sing. p

Therefore, Tom will not dance. $\sim q$

(2) Tom will sing or Tom will dance. $p \vee q$

Tom will dance. q

Therefore, Tom will not sing. $\sim p$

(1) and (2) are invalid because even if both premises are assumed to be true, the truth of the conclusion does not necessarily follow. Though it may be true that Tom will sing (second premise of the first example), it does not follow that he will not dance, since it is possible that Tom will both sing and dance.

We can now state the form of a valid disjunctive syllogism in terms of the following rule:

II. RULE FOR A VALID DISJUNCTIVE SYLLOGISM

1. AFFIRM THE DISJUNCTION in the first premise.
2. DENY ONE DISJUNCT in the second premise.
3. AFFIRM THE OTHER DISJUNCT in the conclusion.

By applying the rule we get a valid argument form:

- (1) affirm the disjunction $p \vee q$ (first premise)
(2) deny one disjunct $\sim p$ (second premise)
(3) affirm the other disjunct q (conclusion)

To check the validity of a disjunctive argument, examine if in the second premise one of the disjuncts has been denied and in the conclusion the other disjunct has been affirmed. If so, then the disjunctive argument is valid.

A violation of the rule would be a case where a disjunction is affirmed in the first premise, one disjunct is affirmed in the second premise and the other disjunct is denied in the conclusion. This violation of the rule is called the fallacy of affirming a disjunct.

To affirm a statement is to accept it as it is. One can affirm not only an affirmative statement but also a negative one. To deny a statement is to affirm its negation. And one can deny both an affirmative and a negative statement. The following table illustrates the point:

<u>Statement</u>	<u>Affirmation</u>	<u>Denial</u>
P	P	$\sim P$
$\sim P$	$\sim P$	$\sim \sim P$

More Than Two Disjuncts.

Smith is tall or eccentric or athletic or intelligent.

But Smith is not tall or eccentric.

Therefore, Smith is athletic or intelligent.

The argument form of this example is:

$(p \vee q) \vee (r \vee s)$ (first premise)
 $\sim(p \vee q)$ (second premise)
 $(r \vee s)$ (conclusion)

The argument form is valid because it conforms to the rule that when we affirm a disjunction in the first premise and we deny one of the disjuncts in the second premise, then we must affirm the other disjunct in the conclusion.

Summary of valid disjunctive argument forms:

1. $p \vee q$ <u>$\sim p$</u> q	2. $p \vee q$ <u>$\sim q$</u> p	3. $\sim p \vee q$ <u>$\sim\sim p$</u> q	4. $\sim p \vee q$ <u>$\sim q$</u> $\sim p$
5. $p \vee \sim q$ <u>$\sim p$</u> $\sim q$	6. $p \vee \sim q$ <u>$\sim\sim q$</u> p	7. $\sim p \vee \sim q$ <u>$\sim\sim p$</u> $\sim q$	8. $\sim p \vee \sim q$ <u>$\sim\sim q$</u> $\sim p$

All these argument forms are variations of the disjunctive syllogism: affirming a disjunction between two propositions, denying one of the disjuncts, and inferring the other disjunct.

Exercises:

4.C.1. Use the Rules to determine which of the following disjunctive syllogisms are valid:

1. X or Y

Not-X

Y

2. X or Y

Y

not-X

3. Not-X or Y

not-(not-X)

Y

4. Not-X or not-Y

Not-(not-Y)

Not-X

5. A or not-B

B

A

6. Not-A or B

Not-A

not-B

7. A or B

Not-B

A

8. A or not-B

not-B

A

9. Not-A or not-B

not-(not-A)

not - not-B

4.C.2. Exercises: Produce the syllogistic form for each of the following arguments, and determine if it is valid or invalid by the Rules:

1. Tom's nervous tension is due to lack of sleep, too much smoking, too much coffee, or overwork. It is not due to overwork or to lack of sleep. Therefore, Tom's nervous tension is due to too much smoking or too much coffee.

2. Mary's car failure is due to a dead battery(p) or an empty gas tank(q). The battery is dead. Therefore, it is not due to an empty gas tank.

3. Capitalism makes rich people richer and poor people poorer or Capitalism exploits weaker countries. It exploits weaker countries. Therefore, capitalism does not make rich people richer and poor people poorer.

4. Nuclear war kills innocent people or nuclear war has no victors. Nuclear war has no victors. Therefore, it does not kill innocent people.

5. Jones or Mary is the culprit. Jones is the culprit. Therefore, Mary is not the culprit.

6. Saudi Arabia or Iran will raise the price of oil. Iran will raise the price of oil. Therefore, Saudi Arabia will not raise the price of oil.

7. Saudi Arabia will buy American F-15s or Saudi Arabia will cut off American oil supply. Saudi Arabia will not cut off American oil supply. So, Saudi Arabia will buy American F-15s.

8. Israel's high inflation will worsen or Israel will request more American aid. Israel's high inflation will worsen. Therefore, Israel will not request more American aid.

9. It is snowing or it is raining. It is snowing. Therefore, it is not raining.

10. Tom is crying or Tom is happy. Tom is happy. Therefore, Tom is not crying.

11. It will rain or it will snow. And since it will rain, therefore, it will not snow.

12. Taxes will go up or go down. But they won't go down. So they'll go up.

13. Tom will call Mary for a date or he will call Jane. Tom called Mary for a date.
Therefore, he won't call Jane.

14. The new coach must be tough or the team will fail. But the new coach is not tough.
I conclude that the team will fail.

15. Tom did not steal the money or he did not receive his inheritance.
But he did receive his inheritance. Therefore, he did not steal the money.

16. John wrote the letter or it was forged. It wasn't forged. Therefore, John wrote it.

17. The subway or the bus will be on time. The subway will be on time.
So, the bus won't be on time.

18. The murderer is the man in the hat or the man with the umbrella. But the murderer is not
the man with the umbrella. Therefore, the murderer is the man in the hat.

19. Tom will buy a shirt or Tom will buy a tie. Tom will buy a shirt.
Therefore, Tom will not buy a tie.

20. Rich countries will aid development in poor countries or rich countries will have chronic
unemployment. Rich countries will not aid development in poor countries. Therefore, rich
countries will have chronic unemployment.

C.III. The Conditional Syllogism

We consider here syllogisms where the first premise is a conditional proposition. An example is the following:

If Ivanisha is a Russian, then Ivanisha drinks vodka. (first premise)

Ivanisha is a Russian. (second premise)

Therefore, Ivanisha drinks vodka. (conclusion)

Recall that in a conditional proposition, the clause following “if” is the antecedent while the clause following “then” is the consequent.

C.III.1. The Mood of a Conditional Syllogism.

Before we can determine which argument forms of the conditional syllogism are valid, we need to know what traditional logicians call its moods. The moods of the conditional syllogism are:

1. The affirming mood (modus ponens), also called the positing mood.
2. The denying mood (modus tollens), also called the sublating mood.

A conditional syllogism is in the **affirming mood** if its second premise affirms the antecedent of the conditional premise, and the conclusion restates, hence affirms the consequent of the conditional.

The symbolic form of this syllogism is:

$p \supset q$

p

q

The following is another example of the affirming mood:

If she is not healthy, then she cannot play.	$\sim p \supset \sim q$
She is not healthy.	$\underline{\sim p}$
Therefore, she cannot play.	$\sim q$

This syllogism is in the affirming mood because the second premise affirms the antecedent and the conclusion affirms the consequent.

The Denying Mood.

A conditional syllogism is in the **denying mood** when the second premise denies the consequent clause of the original conditional, and the conclusion denies the antecedent of that conditional.

Following is an example of a conditional syllogism in the denying mood:

If Ms. Ayandele is a Kenyan, then she is an African.	$p \supset q$
She is not an African.	$\underline{\sim q}$
Therefore, Ms. Ayandele is not a Kenyan.	$\sim p$

Observe that the second premise denies the consequent and the conclusion denies the antecedent of the first premise. Thus, the syllogism is in the denying mood. To deny a statement is to affirm its negation.

4.E.1. Valid Conditional Argument Forms.

Valid Argument Form in the Affirming Mood

Any conditional syllogism in the affirming mood is a valid argument, and can be symbolically represented as follows:

$p \supset q$
\underline{p}
q

Any argument having this structure is an instance of the argument form known as “affirming the antecedent.” In Latin, this valid argument form is called Modus Ponens. The four variations of this valid argument form are:

MP1	MP2	MP3	MP4
$p \supset q$	$\sim p \supset q$	$p \supset \sim q$	$\sim p \supset \sim q$
<u>p</u> _____	<u>$\sim p$</u> _____	<u>p</u> _____	<u>$\sim p$</u> _____
q	q	$\sim q$	$\sim q$

Rule for valid conditional syllogism in the affirming mood:

(1) Affirm the Conditional	(First premise)	$p \supset q$
(2) <u>Affirm the Antecedent</u> _____	(second premise)	<u>p</u> _____
(3) Affirm the Consequent	(conclusion)	q

A violation of this rule, (namely, affirming the consequent in the second premise and affirming the antecedent in the conclusion) is called the fallacy of affirming the consequent.

C.III.2. Invalid Argument Form: Affirming the Consequent

Let us take the following example:

If it rained, then the lawn is wet.	(first premise)
The lawn is wet.	(second premise)
Therefore, it rained.	(conclusion)

In this argument the second premise affirms the consequent rather than the antecedent, while the conclusion affirms the antecedent rather than the consequent. This argument can be symbolized as follows:

$p \supset q$ (first premise)
 \underline{q} (second premise)
 p (conclusion)

Any argument having this form is an instance of the invalid argument form “**affirming the consequent.**” Variations of this invalid argument form are:

$p \supset q$	$\sim p \supset q$	$p \supset \sim q$	$\sim p \supset \sim q$
\underline{q}	\underline{q}	$\underline{\sim q}$	$\underline{\sim q}$
p	$\sim p$	p	$\sim p$

4.C.1. Exercises:

Determine which of the following argument forms in the affirming mood are valid:

- | | | | |
|--|--|--|--|
| 1. $p \supset q$
\underline{q}
p | 2. $\sim p \supset q$
$\underline{\sim p}$
q | 3. $p \supset q$
\underline{p}
q | 4. $\sim p \supset q$
\underline{q}
$\sim p$ |
| 5. $p \supset \sim q$
\underline{p}
$\sim q$ | 6. $p \supset \sim q$
$\underline{\sim q}$
p | 7. $\sim p \supset \sim q$
$\underline{\sim p}$
$\sim q$ | 8. $\sim p \supset \sim q$
$\underline{\sim q}$
$\sim p$ |

4.C.2.- Valid Argument Form in the Denying Mood

Consider the following example:

If it is raining outside then there are clouds in the sky..

There are no clouds in the sky.

Therefore, it is not raining outside.

The conditional is asserted in the first premise, the consequent of the conditional is denied in the second premise and the antecedent of the conditional is denied in the conclusion. The argument is valid because the truth of the premises guarantees the truth of the conclusion. The form of the argument is represented as follows:

$p \supset q$ (first premise)

$\sim q$ (second premise)

$\sim p$ (conclusion)

Any argument having this structure is an instance of the valid argument known as “**denying the consequent**” (Modus Tollens). Variations of this valid argument are:

MT1	MT2	MT3	MT4
$p \supset q$	$\sim p \supset q$	$p \supset \sim q$	$\sim p \supset \sim q$
$\sim q$ _____	$\sim q$ _____	q _____	q _____
$\sim p$	p	$\sim p$	p

I. Invalid Argument Form: Denying the Antecedent

Consider the following example:

If my car breaks down in route, then I will be late for my appointment.

My car did not break down in route.

Therefore, I was not late for my appointment.

In the second premise, the antecedent of the conditional is denied.. However, assuming that my car did not break down in route does not guarantee the truth of the conclusion. The non-fulfillment of the antecedent does not rule out the possible fulfillment of the conclusion by other sufficient conditions that could produce the same effect. For example, I could have been stopped for speeding or delayed by heavy traffic or involved in an accident or ..., and so on. The foregoing argument can be represented as follows:

$p \supset q$	(first premise)
$\underline{\sim p}$	(second premise)
$\sim q$	(conclusion)

Any argument having this structure is an instance of the invalid argument known as “denying the antecedent”. Variations of this invalid form are:

$p \supset q$	$\sim p \supset q$	$p \supset \sim q$	$\sim p \supset \sim q$
$\underline{\sim p}$	\underline{p}	$\underline{\sim p}$	\underline{p}
$\sim q$	$\sim q$	q	q

From the above observations, we can summarize the steps to follow to have a valid conditional syllogism in the denying mood:

Rule for valid conditional syllogism in the Denying Mood:

- (1) Affirm the Conditional (first premise) $p \supset q$
(2) Deny the Consequent (second premise) $\sim q$
(3) Deny the Antecedent (conclusion) $\sim p$

A violation of this rule, namely, the denial of the antecedent in the second premise and the denial of the consequent in the conclusion is called the fallacy of denying the antecedent.

4.C.2. Exercises:

Determine which of the following argument forms in the denying mood are valid:

- | | | | |
|--|--|--|--|
| 1. $p \supset q$
$\sim q$
$\sim p$ | 2. $p \supset \sim q$
q
$\sim p$ | 3. $\sim p \supset q$
p
$\sim q$ | 4. $\sim p \supset \sim q$
p
q |
| 5. $p \supset \sim q$
$\sim p$
q | 6. $\sim p \supset \sim q$
q
p | 7. $\sim p \supset q$
$\sim q$
p | 8. $p \supset q$
$\sim p$
$\sim q$ |

4.C.3. Exercises:

Determining the Validity of Conditional Syllogisms.

Put the following conditional syllogisms in standard form where necessary, then determine their validity by the rules method. If valid, name the valid argument form and if invalid, name the fallacy committed.

1. If man is free, then he is not a machine. But man is not a machine. Therefore, man is free.

2. If America conserves energy, then it can lick inflation. America has not licked inflation. So, America has not conserved energy.

3. Unless you study, you will not pass the test. You did not study; therefore, you will not pass the test.

4. If it gets below freezing tonight, the vegetables will die. It is not going to get below freezing. Therefore, the vegetables will not die.

5. Provided that he works hard, he will keep his job. He did not keep his job. Hence, he did not work hard.

6. Had you gone to the bachelor party, you would have been arrested. You did not go to the bachelor party. That is why you were not arrested.

7. If the hostages are not released, military action might be necessary. The hostages are not released. So, military action might be necessary.

8. If America were firm in its foreign policy, other nations would take it seriously. But other nations do not take America seriously because America has not been firm in its foreign policy.

9. If members of the working class do not get more jobs, they will cause unrest in the land. Members of the working class are causing more unrest in the land. Therefore, members of the working class have not gotten more jobs.

10. If you are a Muslim, then you believe in Allah. You are not a Muslim. Therefore, you are not a believer in Allah.

11. If parents love their children, then their children will grow up loving others. Some parents do not love their children. So, some children do not grow up loving others.

12. If the Republicans get elected, they will favor big business. The Republicans are elected. Therefore, they will favor big business.

13. If high school students are taught basic skills, they will do well in college. They are not doing well in college. Therefore, they have not been taught basic skills.

14. If the stores are closed, then today must be a holiday. The stores are not closed. Therefore today is not a holiday.

15. Provided Jamie cleans her room, her mother will take her to the zoo. Jamie cleaned her room. Therefore, her mother will take her to the zoo.

16. If Billy helped around the house and contributed toward paying bills, then his mother would not have locked him out. His mother locked him out. It must be because Billy did not help around the house and Billy did not contribute toward paying bills.

17. If Mrs. Jones loved her son Billy, then she would not lock him out of the house. But she locked him out of the house. Therefore, Mrs. Jones does not love her son Billy.

Valid Argument Forms:

A. Denying a Disjunct
(Disjunctive Syllogism: DS)

	$p \vee q$	$p \vee q$
	$\underline{\sim p}$	$\underline{\sim q}$
	q	p

B. Affirming the Antecedent
(Modus Ponens: MP)

	$p \supset q$
	\underline{p}
	q

C. Denying the Consequent
(Modus Tollens: MT)

	$p \supset q$
	$\underline{\sim q}$
	$\sim p$

Invalid Argument Forms:

D. Affirming a Disjunct
(Exclusive use of “or”)

	$p \vee q$	$p \vee q$
	\underline{p}	\underline{q}
	$\sim q$	$\sim p$

E. Denying the Antecedent

	$p \supset q$
	$\underline{\sim p}$
	$\sim q$

F. Affirming the consequent

	$p \supset q$
	\underline{q}
	p

4.C.4. Exercises:

Translate the following statements into propositional form and construct valid syllogisms using the conditional proposition as the first premise.

1. Unless Mrs. Jones prevents Billy from using her, Billy will get into the habit of using people.
2. Billy will hurt himself if he takes advantage of the people who love him.
3. Provided Billy is not a freeloader, he can live in his mother's house.
4. When a person is honest, they will have self-respect.
5. If you look only to heaven for your riches, then you will have few riches on earth.
6. Had you followed what I said, you would not be in trouble right now.
7. Segregation should be abolished if it is a form of oppression.
8. If America is truly democratic, it will distribute wealth more equitably.
9. Unless you graduate from college, you will not get a good paying job.
10. When the going gets rough, the tough get going.

4.C.5. Exercises:

Write out the propositional form of the following arguments and determine if they are valid or invalid. Justify your answer by identifying the argument form from the lists given.

1. The battery is dead or the gas tank is empty.

The battery is dead.

Therefore the gas tank is not empty.

2. The electric clock is not plugged in or it is not working.

The electric clock is plugged in.

Therefore it is not working.

3. If this liquid is gasoline, then it is flammable.

It is flammable,

Therefore this liquid is gasoline.

4. If we are going fishing, then we need some bait.

We are going fishing.

Therefore, we need some bait.

5. If it will not rain soon, then we will have a poor harvest.

We will not have a poor harvest.

Therefore, it will rain soon.

6. If the pond is frozen, then we will go ice skating.

The pond is not frozen.

Therefore we will not go ice skating.

7. It is raining or sleet is falling.
Sleet is falling.
Therefore, it is not raining.

8. If welfare programs are cut, many people will suffer.
Welfare programs are not cut.
Therefore, many people will not suffer.

9. Socrates was a Greek or Karl Marx was a Jew.
Socrates was a Greek.
Therefore, Karl Marx was not a Jew.

10. If the dollar declines in value, then imported goods will cost more.
The dollar declines in value.
Therefore imported goods will cost more.

11. I will buy her a watch or a necklace.
I will not buy her a necklace.
Therefore, I will buy her a watch.

12. We will have fish for dinner or we will have steak.
We will not have steak.
Therefore, we will have fish for dinner.

13. America is not strong or other nations hate her.
America is strong.
Therefore, other nations hate her.

14. If we do not unite, we are not strong.
We do not unite.
Therefore, we are not strong.

15. If the law of non-contradiction is false, then knowledge is not possible.

Knowledge is possible.

Therefore, the law of non-contradiction is not false.

16. If there is combustion, then there must be oxygen present.

Oxygen is present,

Therefore there is combustion.

17. If we will not have busing, then we will not have desegregation.

We will not have busing.

Therefore we will not have desegregation.

18. If the teacher is not in the class by noon, then the class will be dismissed.

The teacher is in the class by noon.

Therefore, the class will not be dismissed.

19. If the stock market drops points then many stockowners will lose money.

Many stockowners will not lose money.

Therefore, the stock market will not drop points.

20. If Jane has swallowed arsenic, she will die.

Jane will die.

Therefore, Jane has swallowed arsenic.

D. The Truth-Table

The truth-table method is a technique by means of which we can determine the validity of truth-functional argument forms. A valid argument form is such that if the premises are assumed to be true, the conclusion must be accepted as true. In other words, it is impossible for the conclusion to be false if the premises are assumed to be true. Therefore, if an argument has true premises but a false conclusion, it must be invalid. The truth-table shows graphically whether it is possible for an argument form to have true premises and a false conclusion. If it is not possible for the argument form to have true premises and a false conclusion, then it is valid. The first step in learning the method is learning to compute the truth-value of truth-functional compound propositions.

D.I. Truth-Tables for Compound Propositions.

The **truth-value** of any statement is either true or false. The truth-value of a true statement is true and the truth-value of a false statement is false. Thus, the truth-value of the statement, “John F. Kennedy was assassinated” is true. But a propositional variable cannot be said to be true or false until a statement is substituted for it. Thus, a propositional variable, p, is neither true nor false until it is replaced by a statement like, “John F. Kennedy was assassinated”, which we accept to be true. Otherwise the variable p has no actual truth-value and two possible truth-values. This is graphically represented as follows:

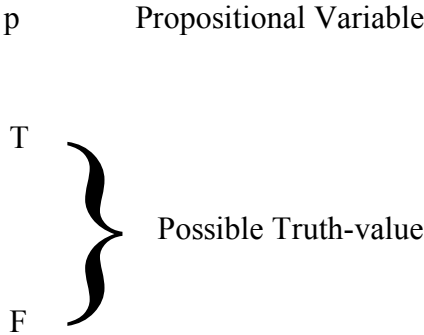

Figure 4.6

This graphic device is called a truth table of one variable. Truth tables are devices that define the basic operations of formal logic on propositions and their possible combinations. Each of the five truth-functional operators mentioned earlier has a corresponding truth-table.

(1) Negation

Definition: Negations are compound propositions formed from a simpler proposition.
 The following truth-table for negation shows that negation of a true statement is false, and the negation of a false statement is true.

II. Truth –Table

	p	~p	~(~p)
Row 1	T	F	T
Row 2	F	T	F

Figure 4.7

It follows from this definition that the truth-value of $\sim(\sim(A))$ is the same as the truth-value of A, and that the truth-value of $\sim(\sim(\sim A))$ is the same as the truth-value for $\sim A$. In general, an even number of negations leaves the truth-value unchanged while an odd number of negations reverses the truth-value.

	p	~p	~~p	~~~p	~~~~p
row 1	T	F	T	F	T
row 2	F	T	F	T	F

Figure 4.8

The logical operators (\bullet , \vee , \supset , \equiv) are used to form compound propositions from two simpler propositions. In any compound proposition formed by using one of these operators, its two constituent propositions will each be either true or false (T or F). This information is summarized in the following table:

	p	q
Row 1	T	T
Row 2	T	F
Row 3	F	T
Row 4	F	F

Figure 4.9

These combinations are generated by means of binary tree diagrams:

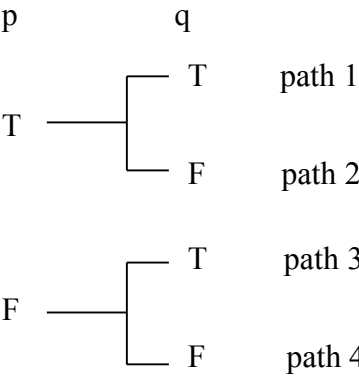

Figure 4.10

Each path of a tree diagram represents a possible way in which the truth-value of one of the constituent propositions can be combined with the truth-value of the other constituent proposition. In the case of a compound proposition made up from three simple propositions, we can use a tree diagram to generate all possible combinations of their truth-values as follows:

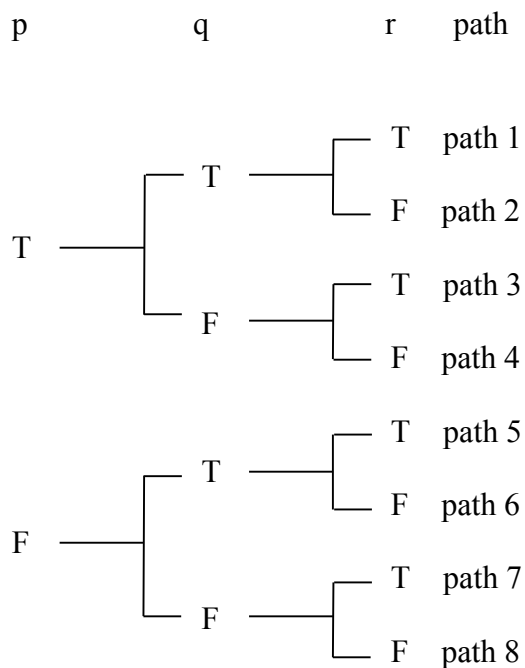

Figure 4.11

This diagram presents all the possible ways in which the truth-values of three propositions can be combined. And if actual statements are substituted for p, q, and r, then one of the eight paths represents the manner in which their truth-values are combined. This information can be presented in truth-table form as follows:

	p	q	r
row			
1	T	T	T
2	T	T	F
3	T	F	T
4	T	F	F
5	F	T	T
6	F	T	F
7	F	F	T
8	F	F	F

Figure 4.12

Each row of the table corresponds to the path with the same number in the tree diagram.

(2) Conjunction ($p \cdot q$)

Definition: A conjunction is true only if all its component statements are true. If p is true and q is true, then $p \cdot q$ is true, otherwise it is false.

Truth-Table:

p	q	$p \cdot q$
T	T	T
F	T	F
T	F	F
F	F	F

Figure 4.13

4. D.1.a. Exercises:

Determine the truth or falsity of the following conjunctions:

1. (Washington, D. C. is the capital of the U.S.) • (Washington, D. C. is the capital of the U.S.).
2. (Rome is the capital of Italy) • (Paris is the capital of France).
3. (London is the capital of Ireland) • (Washington, D. C. is the capital of the U.S.).
4. (A Nigerian is an African) • (A German is a European).
5. (An Englishman is an Indian) • (A Japanese is a European).
6. (Horses are mammals) • (Fish are mammals).
7. (Barack Obama resigned the presidency) • (Donald Trump assumed the presidency).
8. (Chinese are Asians) • (Ethiopians are not Africans),
9. (Water is combustible) • (Gasoline is flammable).
10. (Gold is a precious metal) • (Diamond is a metal).

3. Disjunction $(p \vee q)$

There are two types of disjunctions: exclusive and inclusive. An example of the exclusive disjunction is “Either Jones is in his office or he is in the classroom.” Here the claim is that Jones is in one place or the other but not in both places at once. Thus an **exclusive disjunction** is true in case one of its disjunct is true, but false if both disjuncts are true.

An example of an inclusive disjunction is “Either the dog ran away or the dog was run over by a car.” An **inclusive disjunction** is true if one of the disjuncts is true and is true if both disjuncts are true. In modern logic, the exclusive disjunction is typically defined in terms of the inclusive disjunction. As such, we will confine this discussion of the disjunctive relation to inclusive disjunctions.

Definition: An inclusive disjunction is true in case one or the other or both disjuncts are true; it is false only if both disjuncts are false.

Truth-Table:

p	q	$p \vee q$
T	T	T
T	F	T
F	T	T
F	F	F

Figure 4.14

(4) Conditional ($p \supset q$)

Definition : A conditional statement is false if the antecedent is true but the consequent is false. In all other cases, the conditional is true.

A conditional statement asserts that its antecedent implies its consequent: if p, then q. But note that “p then q” does not assert categorically that q is true, but only that q is true on condition that p is true. Thus, “if p then q” is false only when p is true and q is false.

Truth-Table:

p	q	$p \supset q$
T	T	T (1)
T	F	F (2)
F	T	T (3)
F	F	T (4)

Figure 4.15

Note in line (2) that $p \supset q$ is false if p is true and q is false. For all other substitution instances of p and q, $p \supset q$ is true.

5. Biconditional ($p \equiv q$)

Definition: If p and q both have the same truth-value, that is, if p and q are both true or both false, then $p \equiv q$ is true.

If p and q do not have the same truth-value, so that it is possible for one to be true while the other is false, then $p \equiv q$ is false.

The following truth table illustrates the definition.

Truth Table:

p	q	$p \equiv q$
T	T	T
T	F	F
F	T	F
F	F	T

Figure 4.16

4.D.1 Exercise:

Assume that A , B and C are true statements and X , Y , Z are false statements.

Use truth tables to determine the truth or falsity of the following compounds:

1. If A , then B .
2. If A , then X .
3. If B , then Y .
4. C if B .
5. B provided A .
6. If X , then Z .
7. If Y , then C .
8. If Z , then B .
9. Unless A , then B .
10. Not C , unless B .

4. D.2. Exercise: Use truth tables to determine the truth or falsity of the following compounds:

1. $A \cdot X$
2. $A \cdot B$
3. $C \cdot Y$
4. $C \vee Y$
5. $B \vee Z$
6. $X \vee Z$
7. $Y \vee Z$
8. $Y \supset Z$
9. $Z \supset Y$
10. $Z \supset A$
11. $A \supset Z$
12. $Z \equiv (A \vee X)$
13. $(B \cdot Z) \equiv (Y \supset Z)$

D. III. Determining the Truth-Value of Truth-Functional Compounds:

If we are given the truth-value of the propositions being treated as simple, the truth-tables allow us to calculate the truth-value of any compound proposition constructed from them using logical connectives.

Consider the statement “Today is not Wednesday and today is not Thursday.” The simple statements out of which the compound is formed are:

Tw = Today is Wednesday. Tth = Today is Thursday

The compound statement has the statement form

$$\sim Tw \cdot \sim Tth.$$

This has the propositional form

$$\sim p \bullet \sim q.$$

All statements with this propositional form will have a truth-table which is constructed in accordance with the general format for building a truth table with two variables. The compound propositional form $(\sim p \bullet \sim q)$ is constructed from the two simple propositional variables p and q and each variable has two possible truth-values (either true or false). The following tree diagram shows that there are four possible combinations for two variables:

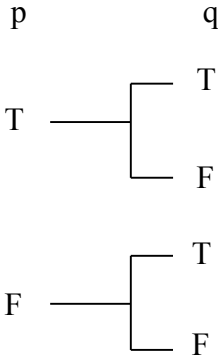

Figure 4.17

The first step in building a truth table is to list all the possible combinations of truth-values for the simple variables p and q .

	p	q
<u>Row 1</u>	T	T
<u>Row 2</u>	T	F
<u>Row 3</u>	F	T
<u>Row 4</u>	F	F
Step	1	1

Figure 4.18

The second step is to determine the truth-value of the level 2 propositions, which are $\sim p$ and $\sim q$. The truth table for negation presented earlier tells us that if p is true, then $\sim p$ is false, and if p is false, then $\sim p$ is true. The same applies for q . The result of these operations can be shown in the following manner.

p	q	$\sim p$	$\sim q$
T	T	F	F
T	F	F	T
F	T	T	F
F	F	T	T

Figure 4.18

The third step is to determine the truth-value of the level 3 propositions. In this case that is the compound $(\sim p \cdot \sim q)$. We know from the truth-table for conjunctions that a conjunction is true if and only if both conjuncts are true. Applying this definition, we can now complete the truth-table:

p	q	$\sim p$	$\sim q$	$\sim p \cdot \sim q$	
T	T	F	F	F	
T	F	F	T	F	
F	T	T	F	F	
F	F	T	T	T	
Steps	1	1	2	2	3

Figure 4.19

This procedure could be condensed simply by carrying out each step beneath the appropriate operator in the proposition as follows:

	\sim	p	\cdot	\sim	q
	F	T	F	F	T
	F	T	F	T	F
	T	F	F	F	T
	T	F	T	T	F
Steps	2	1	3	2	1

Figure 4.20

The truth tables show clearly how the truth-value of a compound proposition is directly calculated from the truth-values of its highest level constituent propositions. This can be shown by a logic diagram as well:

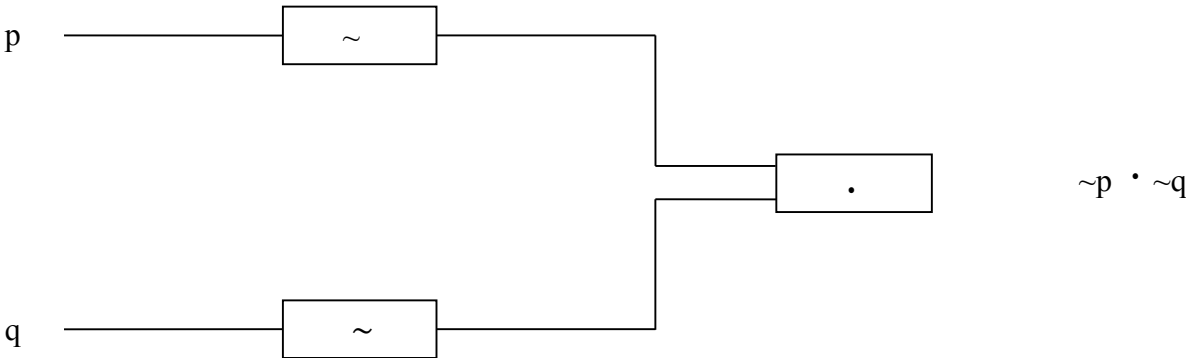

Figure 4.21

V. Building a Truth Table for three or more variables. For a compound form with three or more variables, the same procedure as described above is followed, except that there are more steps. Thus let us determine the truth table for the following statement: If the school has a good soccer team, then either the coach is not a novice or most of the players are foreign students.

The statement form for the above example is $p \supset (\sim q \vee r)$, which is a conditional statement. The first step in building a truth table for this proposition is to list all the possible ways that three propositions could be true or false together. This set of possibilities (called “permutations”) is generated by a tree diagram and determines the rows of the truth table as follows:

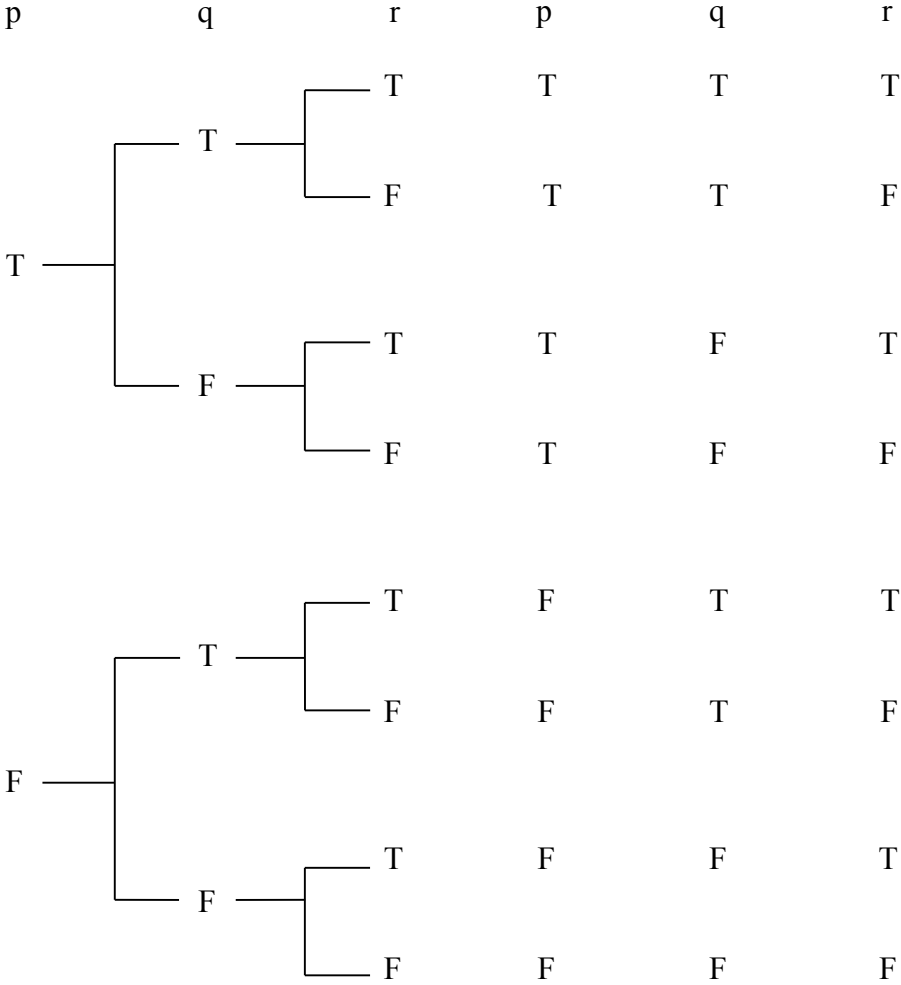

Figure 4.22

Each path of the tree diagram is identical to a row in the truth table. And each row represents one of the possible ways that the simple propositions could be true or false together.

There are 2 rows in a truth table of 1 variable, 4 rows in a truth table of 2 variables, and 8 rows in a truth table of 3 variables. Adding an additional variable always doubles the number of rows. Thus, a proposition containing n variables always generates a truth table with 2^n rows. In the complete truth table, the total number of columns is the sum of the total number of simple propositions and the total number of logical operators.

We can use the logic diagram and truth table of the propositional form $p \supset (\sim q \vee r)$ to illustrate these relationships:

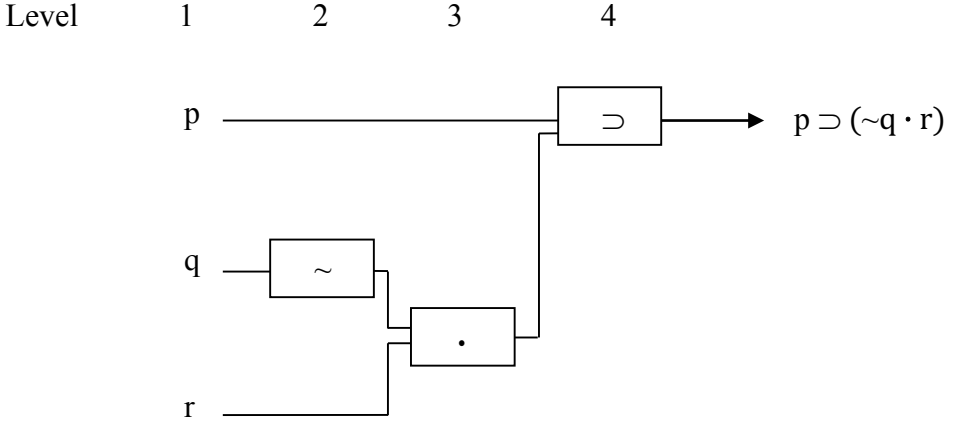
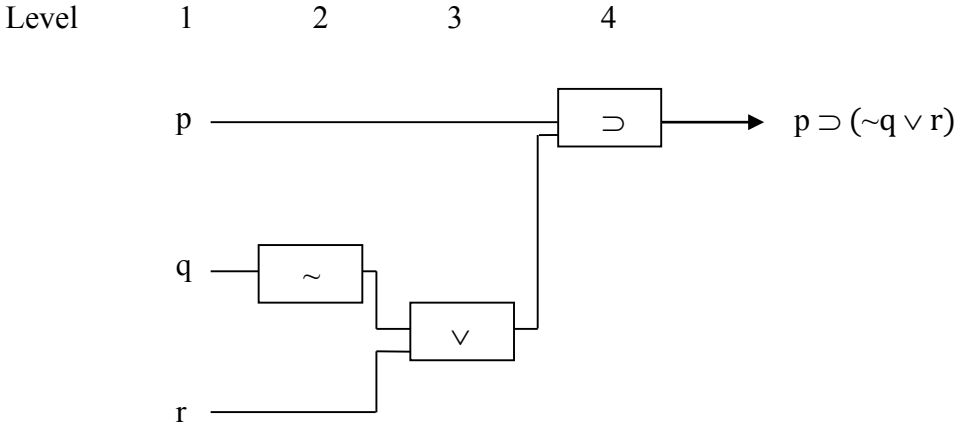

Figure 4.23

p	q	r	$\sim q$	$\sim q \cdot r$	$p \supset (\sim q \cdot r)$
T	T	T	F	F	F
T	T	F	F	F	F
T	F	T	T	T	T
T	F	F	T	F	F
F	T	T	F	F	T
F	T	F	F	F	T
F	F	T	T	T	T
F	F	F	T	F	T

1	1	1	2	3	4
---	---	---	---	---	---

Figure 4.24

The condensed version is:

p	\supset	(\sim	q	\cdot	r)
T	T	F	T	T	T	T
T	F	F	T	F	F	F
T	T	T	F	T	T	T
T	T	T	F	F	T	F
F	T	F	T	T	T	T
F	T	F	T	F	F	F
F	T	T	F	T	T	T
F	T	T	F	F	T	F

1	4	2	1	3	1
---	---	---	---	---	---

Figure 4.25

The rules for constructing a truth table for a level k proposition with n-variables are:

1. Draw a tree diagram for n variables
 2. For each path of the tree diagram, write out the combination of truth-values as a row of the truth table;
 3. Write out all level two propositions in the compound;
 4. Calculate the truth-values of each level 2 proposition for each row of the truth table;
 5. Write out all level 3 propositions in the compound;
 6. Calculate the truth-value of each level 3 proposition for each row of the truth table.
 7. Write out all level 4 propositions;
 - :
 - :
 - :
- penultimate-steps.

Write out all k-1 level propositions and calculate their truth-values for each row of the truth table.

final-step. Write out the k level proposition and calculate its truth-value for each row of the truth table.

4D.3. Exercises:

Assuming A, B, C are True and X, Y, Z are False, use a condensed version of the truth table to determine the truth-value of each of the following statement forms

- | | |
|----------------------------|--|
| 1. $A \cdot B$ | 11. $(A \cdot B) \vee C$ |
| 2. $B \vee X$ | 12. $B \supset (A \vee Z)$ |
| 3. $A \vee B$ | 13. $\sim X \cdot Y$ |
| 4. $X \vee Y$ | 14. $A \vee \sim B$ |
| 5. $B \supset Y$ | 15. $B \supset (\sim A \equiv X)$ |
| 6. $\sim A \supset B$ | 16. $\sim A \supset (\sim B \cdot C)$ |
| 7. $X \supset \sim A$ | 17. $A \vee (C \supset \sim Y)$ |
| 8. $\sim C \supset Z$ | 18. $(B \cdot Z) \supset (C \vee Y)$ |
| 9. $Y \equiv \sim Z$ | 19. $(B \cdot C) \supset (\sim A \vee \sim Z)$ |
| 10. $A \supset (B \vee C)$ | 20. $[A \supset (C \supset \sim B)] \supset [(X \vee \sim Y) \supset Z]$ |

4.D.III. Tautologies, Contradictions and Contingencies

A compound proposition that comes out true for all possible assignments of truth-values to its constituent simple propositions is called a tautology. Thus, the compound proposition "It is not the case that John is at home and John is not at home" has the propositional form $\sim (p \cdot \sim p)$. Its truth table is:

	\sim	(p	\cdot	\sim	p)
Line (1)	T	T	F	F	T	T
Line (2)	T	F	F	T	F	F
Steps	4	1	3	2	1	

Figure 4.26

As we can see from lines 1 and 2, whether p is true or false, the compound statement comes out true. As this example illustrates, a tautology is true irrespective of the truth-value of its constituent propositions.

A compound proposition that comes out false for all possible assignments of truth-values to its constituent simple propositions is called a contradiction. For example, the proposition "Mary is industrious and May is not industrious" has the propositional form " $p \cdot \sim p$ ". Its truth table is:

	(p	\cdot	\sim	p)
Line (1)	T	F	F	T	F
Line (2)	F	F	T	F	F
Steps	1	3	2	1	

Figure 4.27

Whether “Mary is industrious” is true or false, the statement “Mary is industrious and Mary is not industrious” is false. A contradiction is false irrespective of the truth-value of its constituent propositions.

A compound proposition is contingent if the truth-value of the compound proposition is changed with changes in the truth-values of its constituent propositions. Thus, the proposition “Tom is hungry and Bill is not thirsty” has the propositional form “ $p \cdot \sim q$ ” and is false if p is false or q is true. It is true only when p is true and q is false. The truth table for the proposition is:

	p	q	(p	·	~	q)
Line (1)	T	T	T	F	F	T
Line (2)	T	F	T	T	T	F
Line (3)	F	T	F	F	F	T
Line (4)	F	F	F	F	T	F
Steps	1	1	1	3	2	1

Figure 4.28

4.D.4. Exercises: Use truth tables to determine which of the following compound propositional forms are contingent, contradictory, or tautological.

- | | |
|--|---|
| 1. $p \supset (q \vee p)$ | 6. $(p \supset q) \equiv (\sim p \vee q)$ |
| 2. $q \supset (\sim p \vee q)$ | 7. $(p \cdot \sim q) \vee (p \supset q)$ |
| 3. $[p \cdot (q \cdot r)] \cdot [p \supset (q \cdot r)]$ | 8. $p \vee (q \vee p)$ |
| 4. $p \vee (p \cdot q)$ | 9. $\sim (p \vee \sim p) \cdot (q \cdot q)$ |
| 5. $\sim (p \vee q) \cdot (q \vee p)$ | 10. $[(p \vee q) \cdot p] \supset q$ |

4.D Truth Tables for Arguments

When arguments are constructed using simple propositions and truth functional compound propositions, it is possible to use truth tables to determine the validity or invalidity of the argument. We can determine the validity of such arguments by seeing whether the conclusion is necessarily true when the premises are assumed true. This can be done by using truth tables for truth-functional arguments.

4.G.1. Truth Tables of Disjunctive Syllogisms

Let us test the following disjunctive argument form:

- | | | |
|----------------------------|--------------|-------------------------------|
| $p \vee q$ | (premise 1) | |
| <u>$\sim p$</u> | (premise 2) | |
| q | (conclusion) | or $p \vee q. / \sim p. // q$ |

To test the validity of the above argument form, we construct its truth table as follows:

Column	1	2	3	4
	p	q	$p \vee q$	$\sim p$
(1)	T	T	T	F
(2)	T	F	T	F
(3)	F	T	T	T
(4)	F	F	F	T

Figure 4.29

Columns 1 and 2 list all the possible ways that the variables p and q can be true and false together. Column 3 is filled in by reference to the first two columns in accordance with the definition of a disjunctive proposition. The fourth column, $\sim p$, is filled in as the negation of column 1.

Examining the finished table, we see that only the third row shows both premises to be true. But the conclusion here is also true. Thus, there is no case in which both premises are true and the conclusion false. The syllogism is therefore valid.

Let us now consider the truth table for the following invalid argument:

The dog ran away or the dog was injured by a car.

The dog ran away.

Therefore, the dog was not injured by a car.

The argument form is as follows:

$$\begin{array}{l}
 p \vee q \\
 \underline{p} \\
 \sim q \quad \text{or} \quad p \vee q. / p. // \sim q
 \end{array}$$

The truth table for this form is as follows:

	Premise 2		Premise 1	Conclusion
	p	q	$p \vee q$	$\sim q$
(1)	T	T	T	F
(2)	T	F	T	T
(3)	F	T	T	F
(4)	F	F	F	T

Figure 4.30

Line (1) proves the argument form invalid, for both premises are true but the conclusion is false. Whenever it is possible to demonstrate that an argument form can have true premises and a false conclusion, that argument form is proven to be invalid.

4.G.1. Exercises:

A. Use the truth-table method to determine which of the following argument forms are valid or invalid.

- | | | | |
|--|---|---|---|
| 1. $p \vee q$
$\sim q$ _____
p | 2. $p \vee q$
$\sim p$ _____
q | 3. $p \vee q$
p _____
$\sim q$ | 4. $p \vee q$
q _____
$\sim p$ |
| 5. $\sim p \vee q$
p _____
q | 6. $\sim p \vee q$
$\sim p$ _____
q | 7. $\sim p \vee q$
q _____
p | 8. $\sim p \vee q$
$\sim q$ _____
$\sim p$ |
| 9. $p \vee \sim q$
$\sim p$ _____
$\sim q$ | 10. $p \vee \sim q$
q _____
p | 11. $p \vee \sim q$
p _____
q | 12. $p \vee \sim q$
$\sim q$ _____
$\sim p$ |

B. Use the truth-table method to prove which of the following disjunctive syllogisms are valid.

1. Jones is the employee or the employer. Jones is not the employee. Therefore, he is the employer.
2. She is sick or is on leave. She is on leave. Therefore, she is not sick.
3. Your behavior is either very rash or very stupid. It is very rash. Therefore, it is not very stupid.
4. The store went out of business either because of poor management or because of poor sales. It was because of poor sales. Therefore, it was not because of poor management.
5. The heater stopped working because the pilot light is out or because the blower is defective. The pilot light is not out. Therefore, the blower is defective.

6. Billy neither helps around the house nor contributes toward paying bills. Billy did not help around the house. Therefore, he contributed toward paying bills.
7. Billy is a freeloader or a user of others. Billy is a user of others. Therefore, he is not a freeloader.
8. Mrs. Jones loves her son Billy or she punishes him. Mrs. Jones punishes her son. Therefore, she does not love her son.
9. Billy avoids his responsibilities or is inconsiderate of others. He is not inconsiderate of others. Therefore, he avoids his responsibilities.
10. He will give her love or money. He gave her money. Therefore, he did not give her love.
11. She is young or beautiful. She is not young. Therefore, she is beautiful.
12. Eric Heiden will speed skate or Eric Heiden will bike race. Eric Heiden will speed skate. Therefore he will not bike race.
13. Iran will surrender the hostages or America will be humiliated. Iran will not surrender the hostages. Therefore America will be humiliated.
14. Third-world nations will be economically developed or America will become richer and richer. America is becoming richer and richer. Therefore, third-world nations will not be economically developed.
15. The University of Connecticut has a good women's basketball team or the University of Connecticut has a good men's basketball team. The University of Connecticut has a good women's basketball team. Therefore, the University of Connecticut does not have a good men's basketball team.

4.G.2 The Truth Tables of Conditional Syllogisms.

Consider the following example:

If Ivan is a tiger, then Ivan eats meat.

Ivan is a tiger.

Therefore, Ivan eats meat.

The argument form of the above example is represented thus:

$p \supset q$ (first premise)
 p (second premise)
 q (third premise)
 $p \supset q / p // q$

We can test the validity of this argument form by constructing its truth table and examining it to determine whether there is a substitution instance in which the premises are true and the conclusion false. If we find such a case, then the argument form is invalid. If not, then the argument form is valid since in all its substitution instances, there is no case in which there is a false conclusion and true premises.

	Premise 2	Conclusion	Premise 1
	p	q	$p \supset q$
(1)	T	T	T
(2)	T	F	F
(3)	F	T	T
(4)	F	F	T

Figure 4.31

We look for those lines in which the premises are both true. This occurs only in line (1). But notice that the conclusion here is true. Therefore the argument is valid. Any argument of the form

$$\begin{array}{l}
 p \supset q \\
 p \\
 \hline
 q \qquad \text{or} \qquad p \supset q / p // q
 \end{array}$$

is valid, regardless of what statements we substitute for p and q . For there is no substitution instance in which the premises are true and the conclusion false. Medieval logicians called this valid form Modus ponens.

Let us next consider an invalid syllogism in the affirming mood.

If Amy eats crabs, Amy has an allergic reaction.	$p \supset q$
Amy has an allergic reaction.	q
So, Amy ate crabs.	p

Constructing the truth-table, we get:

	Conclusion	Premise 2	Premise 1
	p	q	$p \supset q$
(1)	T	T	T
(2)	T	F	F
(3)	F	T	T
(4)	F	F	T

Figure 4.32

Again, we look for a substitution instance in which both premises are true. We find this in lines (1) and (3). But the conclusion of line (1) is true. Hence, this line does not prove that the argument is invalid. On the other hand, the conclusion of line (3) is false. Thus, line (3) has true premises and a false conclusion, which proves that the argument is invalid. We conclude that any argument of the form

$$\begin{array}{c} p \supset q \\ q \\ \hline p \end{array} \quad \text{or} \quad p \supset q / q // p$$

is always invalid. The fallacy involved in this form is called the fallacy of affirming the consequent.

4.G.2. Exercises:

A. Use the truth table method to determine the validity of the following conditional argument forms.

1. $p \supset q / \sim q // p$
2. $p \supset q / \sim p // q$
3. $p \supset q / p // \sim q$
4. $p \supset q / q // \sim p$
5. $\sim p \supset q / p // q$
6. $\sim p \supset q / \sim p // q$
7. $\sim p \supset q / q // p$
8. $\sim p \supset q / \sim q // \sim p$
9. $p \supset \sim q / \sim p // \sim q$
10. $p \supset \sim q / q // \sim p$
11. $p \supset \sim q / p // q$
12. $p \supset \sim q / \sim q // \sim p$

B. Use the truth table method to determine the validity of the following conditional arguments. Put in standard form where necessary.

1. If you overeat, then you will get a stomachache. You are over eating; therefore you will get a stomachache.

2. If it snows hard, then I will not go to work. I will not go to work. So it must have snowed hard.

3. If the sun shines, then we can play outdoors. The sun is shining today; so we can play outdoors today.

4. If inflation continues, then I cannot afford to buy steaks. I cannot afford to buy steaks; therefore inflation continues.

5. If my team does not win, then I will eat my hat. My team did win; therefore, I will not eat my hat.

6. Provided Jamie cleans her room, her mother will take her to the zoo. Her mother took her to the zoo. Therefore, Jamie cleaned her room.

7. If Billy helps around the house and contributes toward paying bills, then his mother will not lock him out. His mother locks him out. Therefore, Billy did not help around the house or Billy did not contribute toward paying bills.

8. If Mrs. Jones loves her son Billy, then she will not lock him out of the house. But she did lock him out of the house. Therefore, Mrs. Jones does not love her son Billy.

9. Unless Mrs. Jones prevents Billy from using her, then Billy will get into the habit of using people. Mrs. Jones does prevent Billy from using her. Therefore, Billy will not get into the habit of using people.

10. Billy will hurt himself, if he takes advantage of the people who love him. Billy hurts himself, because he takes advantage of the people who love him.

11. Provided that Billy is not a freeloader, then he can live in his mother's house. Billy is a freeloader. Therefore, he cannot live in his mother's house.

12. You will get high blood pressure in case you do not exercise. You exercised. Therefore, you will not get high blood pressure.

13. On condition that Jane is honest, then Jane will have self-respect. Jane does have self-respect. Therefore, Jane is honest.

14. If you look only to heaven for your riches, then you will have no riches on earth. But you do have riches on earth. Therefore, you do not look only to heaven for your riches.

15. If opportunity knocks at your door, then take advantage of it. You did not take advantage of your opportunity. Therefore, opportunity did not knock at your door.

Quantification

4.H Quantifiers

1. A propositional form, ψx , becomes an actual proposition when we substitute the names of a specific property for the predicate variables, ψ , and the name of a specific individual for the individual variable, x . Thus if the predicate, M^1 , is the property of being a mother, then $M_1x = x$ is a mother. And if the individual in question is $f = Ms$ Flotmos, then $M_1f = Ms$ Flotmos is a mother. In this way, a proposition attributes specific properties to specific individuals. And it then becomes either true or false. But this way of forming true or false propositions is limited. For there are many true or false propositions that do not contain the name of any particular individual, such as “All females are mothers,” “No females are mothers,” “Some mothers are female,” or “Some mothers are not females.”

With the addition of quantifiers, it is possible to express the A, E, I, and O propositional forms of traditional Aristotelian logic in terms of the propositional forms of modern truth functional logic. (x) , which should be read ‘for every x ’, is called the **universal quantifier**. This

quantifier takes the place of “all” and “no” in the Aristotelian system. $(\exists x)$, which should be read ‘there exists an x’, is called the **existential quantifier**, and takes the place of ‘some’ in the Aristotelian system. The propositional forms of Aristotelian logic translate into the propositional forms of truth-functional logic as follows:

Aristotelian	Truth-Functional	Read (Boolean)
A: All S are P	$(x) (Sx \supset Px)$	For every x, if x is S then x is P.
E: No S are P	$(x) (Sx \supset \sim Px)$	For every x, if x is S then x is not P.
I: Some S are P	$(\exists x) (Sx \cdot Px)$	There exists an x such that x is S and x is P
O: Some S are	$(\exists x) (Sx \cdot \sim Px)$	There exists an x such that x is S not P and x is not P

Following are examples of translations between Truth-functional and Aristotelian forms:

T-F Form	Read	Aristotelian Form
$(x) Wx$	For every x, x is W	All things are W.
$(x) \sim Wx$	For every x, x is $\sim W$	No things are W.
$\sim (x) Wx$	It is false that for every x, x is W	It is not the case that all things are W
$\sim (x) \sim Wx$	It is false that nothing is W	It is not the case that every x is not W.
$(\exists x) Dx$	There exists an x such that x is D	Something is D.
$(\exists x) \sim Dx$	There exists an x such that x is not D.	Something is not D.
$\sim (\exists x) Dx$	It is false that there exists an x such that x is D	It is not the case that something is D.
$\sim (\exists x) \sim Dx$	It is false that there exists an x such that x is not D.	It is not the case that something is not D.

4.H.1 Exercises:

Using quantifiers, translate each of the following categorical forms into truth-functional form.

1. All individuals that are A's and B's are C's
2. All individuals that are A's are B and C
3. Only individuals that are A's are B's
4. No individuals that are B's or C's are A's
5. Every individual that does not vote is a free-rider.
6. Few individuals that are A are B
7. A few individuals that are A are B more exercises

4.I. Mixed Quantifiers

Quantifiers allow us to make true and false statements without referring to specific individuals. The A, E, I, and O forms involve the use of quantifiers with **monadic predicates** (applied to one individual). But quantifiers are also commonly used with predicates that refer, not to a single individual, but to a relationship between two or more individuals. These are called **relational predicates**. To illustrate, let $f = Ms$. Flotmos, and $M^1xy = x$ is the mother of y . If it is true that f is a mother, then it is true that there exists someone to whom f is a mother of, even if we do not know who that individual is. In truth-functional terms, $M_1f \supset (\exists y)M_1fy$. The following examples illustrate how quantifiers are used with two-place predicates.

Let $b = \text{Bill Clinton}$ $h = \text{Hilary Clinton}$ $Lxy = x \text{ loves } y$.

Then the following relations are translated as:

1. Lhb Hilary loves Bill.
2. Lbb Bill loves Bill.
3. Lbh Bill loves Hilary.
4. $\sim(Lhb \supset Lbh)$ It is false that if Hilary loves Bill then Bill loves Hilary.

5. $(x)Lxb$ Everybody loves Bill.
6. $(\exists x)Lxb$ Somebody loves Bill
7. $(x)(\exists y)Lxy$ Everybody loves somebody.
8. $(\exists y)(x)Lxy$ There is somebody that everybody loves
9. $(\exists x)(y)Lxy$ There is somebody that loves everybody.

The order of the names used in a relational statements matters, so that $Lhb \neq Lbh$. If Hilary loves bill, it does not follow that bill loves Hilary. Likewise, the order of mixed quantifiers matters. Thus, $(x)(\exists y)Lxy \neq (\exists y)(x)Lxy$. If every person has someone who loves them, it does not follow that there is someone that everybody loves.

4.H Exercises:

- 4.H.1. Let $b = \text{Bill Clinton}$, $h = \text{Hilary Clinton}$, $d = \text{Donald Trump}$, $i = \text{Irena Trump}$,
 $o = \text{Barack Obama}$ $m = \text{Michelle Obama}$ $c = \text{Chelsea}$ $t = \text{t Trump}$
 $s = \text{Sashsa Obama}$

$M_1xy = x \text{ is the mother of } y$ $M_2xy = x \text{ is married to } y$ $Lxy = x \text{ loves } y$

Given your knowledge of the celebrities above, construct three false and three true statements.

More exercises needed

4.H.2_ Using the following conventions, translate the symbolic statements into English.

$Cxy = x$ cleans y 's room. $Axy = x$ is angry with y
 $Zxy = x$ takes y for a treat. $M_1xy = x$ is the mother of y
 $f =$ Ms Flotmos $j =$ Jamie

1. $(\exists y)A_jy$ _____
2. $(x)Z_xj$ _____
3. $(y)Z_jy$ _____
4. $(x)(\exists y)Z_{xy}$ _____
5. $(\exists y)(x)Z_{xy}$ _____
6. $(y)A_{fy}$ _____
7. $(x)A_{xf}$ _____
8. $(\exists x)A_{xf}$ _____
9. $(\exists x)M_{1xj}$ _____
10. $(\exists x)M_{1xf}$ _____
11. $(\exists x)(M_{1xj} \cdot M_{xf})$ _____
12. $(x)(C_{xx} > Z_{fx})$ _____

more exercises

Free vs Bound Variables

A variable x is free if it is an element in a statement form that is not quantified. Thus M_1x ($= x$ is a mother) is a statement form that is neither true nor false because the variable x has no referent. In such cases, we say that x is free. The statement form M_1x can become a statement in two ways:

(1) when the name of a specific individual is substituted for x . In such cases, we say that M_1x is instantiated. Thus M_1b would be a false instantiation of M_1x . And M_1i would be a true instantiation of M_1x .

(2) when the variable x is quantified to make a universal or particular claim. Thus, $(x)M_1x$ would be false and $(\exists x)M_1x$ would be true.

When we use quantifiers to make statement forms into statements, all variables used in the statement must be bound by a quantifier. For a statement form to become a statement, each variable used in the statement form must be either instantiated with an individual or bound by some quantifier.

Exercises:

In each of the following, indicate which variables are bound and which are free:

(x) Mxy

($\forall y$) Mxy

(y) ($Mxy \supset Myx$)

(y) ($\exists x$) ($Mxy \supset Myx$)

(x) ($Cxy \supset Zfx$)

more exercises

Chpt. 5: Applications of Modern Logic

Logic and Computers

Logic and Probability

Logic and Computers

4.I.1 People normally process verbal information in much the same way it is processed in truth-functional logic, and inferences such as “ $P \supset Q / P // Q$ ” are intuitively made and recognized as correct. We will now indicate how devices such as calculators and computers are constructed so that they process information in this manner. This is accomplished by first representing propositions in terms of circuit diagrams.

1. Let the propositional form P be represented by the following circuit:

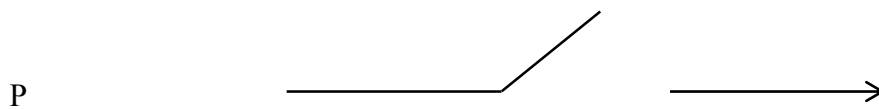

Electricity can flow from beginning to end continuously if and only if gate P is down:

P is down Path a-b is continuous

T	T
F	F

2. Let the propositional form $\sim P$ be represented by the following **inverted circuit**:

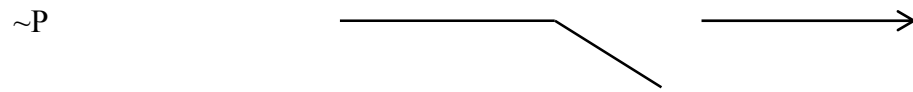

Here, the path is continuous if and only if gate P is not down:

P is down Path a-b is continuous

T	F
F	T

3. Let the propositional form $(P \cdot Q)$ be represented by the following **series circuit**:

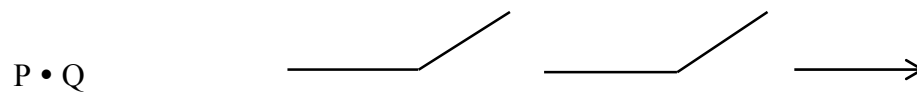

Here, the path from a to b is continuous if and only if gate P is down and gate Q is down:

P (is down) and Q (is down) Path a-b is continuous

T	T	T	T
T	F	F	F
F	F	T	F
F	F	F	F

4. Let the propositional form $(P \vee Q)$ be represented by the following **parallel circuit**:

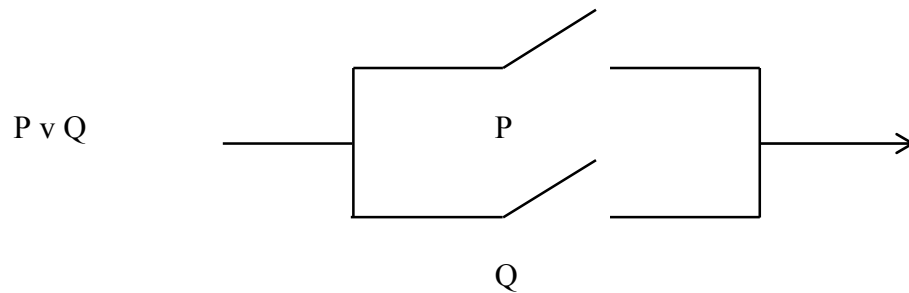

In this diagram, there is a continuous path from a to b in all cases except that in which it is false that P is down and it is false that Q is down:

P is down	or	Q is down	Path is continuous
T	T	T	T
T	T	F	T
F	T	T	T
F	F	F	F

When we envision the path from beginning to end as the circuit followed by an electric current, the above diagrams are called switching circuits: diagram 2 is called an inverted circuit; diagram 3 is called a series circuit; and diagram 4 is called a parallel circuit. By giving circuit analogues of the connectives \sim , \vee , and \cdot , it is possible to construct circuits that process electrical signals in exactly the same manner that compound propositions process truth values. The output of a circuit is determined by the combined operation of the switches in the same way as the truth value of a compound proposition is determined by the operation of the truth functional connectives on the atomic propositions.

Some examples of circuit diagrams for compound truth functional propositions are as follows:

Propositional Form

Circuit Diagram

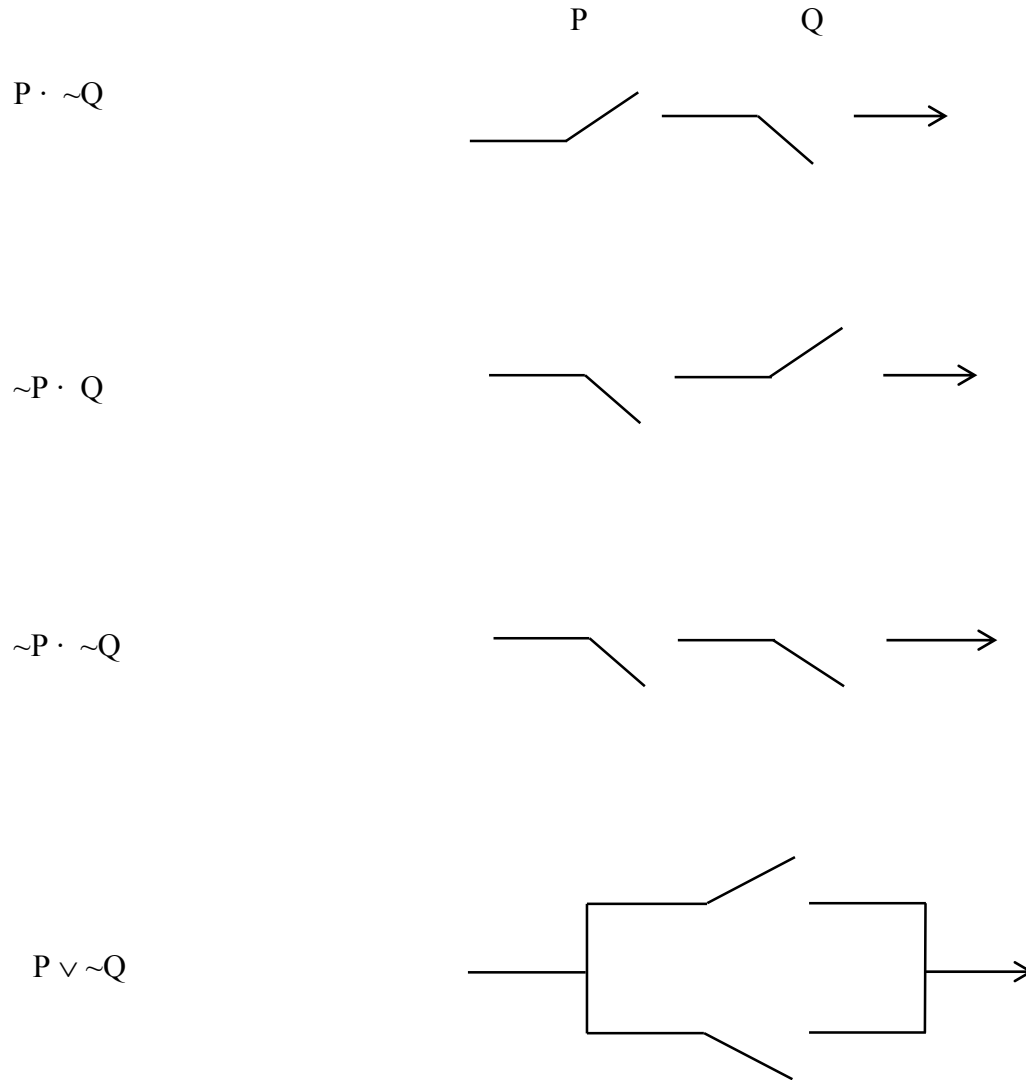

$$P \cdot (\sim P \vee \sim Q)$$

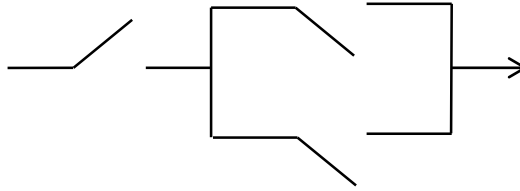

4.I.1. Exercises: Draw the circuit diagram for each of the following propositional forms:

1. $\sim p \vee (\sim q \vee p)$
2. $p \cdot (q \vee \sim p)$
3. $(p \cdot \sim q) \vee (\sim p \vee q)$
4. $(p \cdot q) \vee (\sim p \cdot \sim q)$
5. $(p \vee q) \cdot (\sim p \vee \sim q)$

4.I.2 Disjunctive Normal Forms

Many propositional forms, such as $\sim (P \vee Q)$ and $(P \supset Q)$, can not be represented directly by a circuit diagram. But by deriving propositional forms that are the equivalent of such propositions, it is possible to construct circuits that give equivalent outputs. The propositional form $(P \supset Q)$ is constructed from the simple propositions P and Q and has the following truth table:

P	Q	$P \supset Q$
T	T	T
T	F	F
F	T	T
F	F	T

To derive its disjunctive normal form, follow the steps below:

- Step 1. On each row where $P \supset Q$ is true, write down the simple propositions that are true and write down the negation of the simple propositions that are false.
- Step 2. On each row where $P \supset Q$ is true, form the conjunction of the simple propositions and the negations of the simple propositions as determined in Step 1.
- Step 3. Form the disjunction of the conjoined statements determined in Step 2.

P	Q	$P \supset Q$	Step 1	Step 2
T	T	T	P Q	$P \cdot Q$
T	F	F		
F	T	T	$\sim P$ Q	$\sim P \cdot Q$
F	F	T	$\sim P$ $\sim Q$	$\sim P \cdot \sim Q$

Step 3 is then $(P \cdot Q) \vee (\sim P \cdot Q) \vee (\sim P \cdot \sim Q)$

Because $P \supset Q$ has the same truth table as $(P \cdot Q) \vee (\sim P \cdot Q) \vee (\sim P \cdot \sim Q)$, they are truth-functionally equivalent. $P \supset Q$ also has the same truth table as $\sim P \vee Q$. Thus

$$P \supset Q \equiv (P \cdot Q) \vee (\sim P \cdot Q) \vee (\sim P \cdot \sim Q) \equiv (\sim P \vee Q).$$

The DNF circuit diagram for $P \supset Q$ and all other statements that are truth functionally equivalent to it is thus:

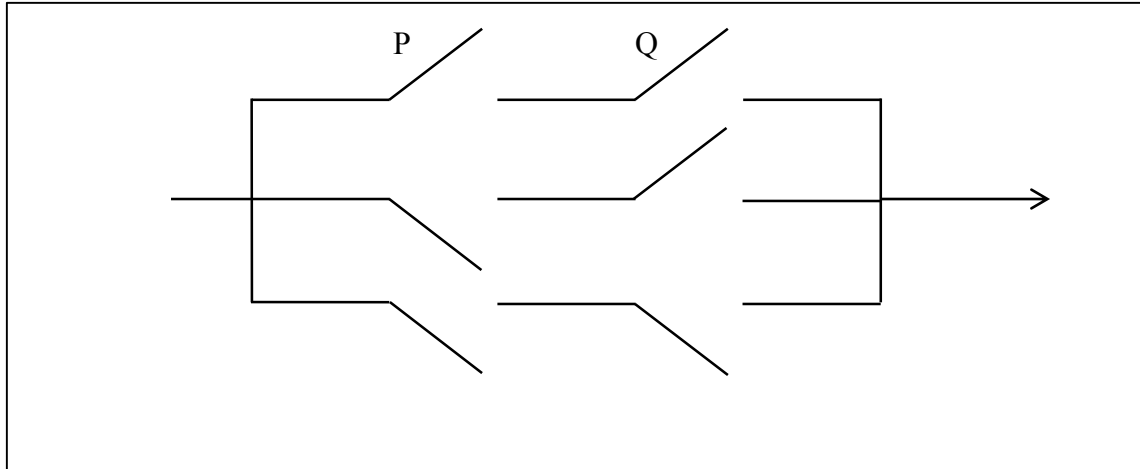

Any compound of two propositions can be represented by a parallel circuit consisting of at most four series circuits by constructing its DNF.

4.I.2. Exercises:

1. Derive the Disjunctive Normal Form of each of the following propositions:
 - a. $P \supset \sim Q$
 - b. $\sim (P \supset Q)$
 - c. $P \equiv Q$
 - d. $\sim P \equiv \sim Q$
 - e. $\sim P \supset \sim Q$

2. Draw the circuit diagram of each of the above DNFs.

3. For each of the following propositional forms, draw a circuit diagram that gives equivalent outputs:
 1. $(P \supset Q) \cdot \sim Q$
 2. $(P \cdot Q) \supset (\sim Q \vee \sim P)$
 3. $\sim P \equiv (\sim Q \cdot P)$

$$4. P \supset (Q \supset P)$$

$$5. \sim P \vee (\sim Q \equiv P)$$

I.4 Because there are so many ways of engineering the on-off action of a switch (relays, electro-magnetics, vacuum tubes, transistors, etc.), we ignore details as to how a switch is constructed and concern ourselves only with their inputs and outputs. In computer language, a switch is a “black box” and only its input and output is considered relevant. The logical connectives are conventionally represented as “black boxes” in logic diagrams:

Propositional Form

Logic Connective

Computer Gate

$P \cdot Q$ (P and Q)

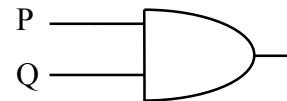
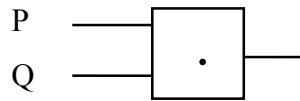

$P \vee Q$ (P or Q)

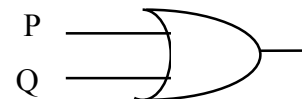
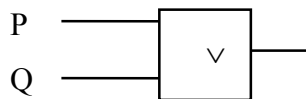

$\sim P$ (not P)

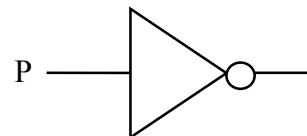
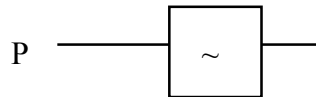

We have seen that one way of resolving the ambiguity involved in a statement like $(P \cdot Q \vee R)$ is to represent it in terms of a logic diagram. Logic diagrams indicate the order in which simple propositions are compounded in order to form successive levels of compound propositions. The propositional form $(P \cdot Q \vee R)$ is ambiguous because it does not tell us

whether P should be grouped with Q and their compound grouped with R, or whether Q should be grouped with R, and then their compound grouped with P. It is ambiguous between the following two propositional forms:

a. $(P \cdot Q) \vee R$

b. $P \cdot (Q \vee R)$

Their respective logic diagrams are as follows:

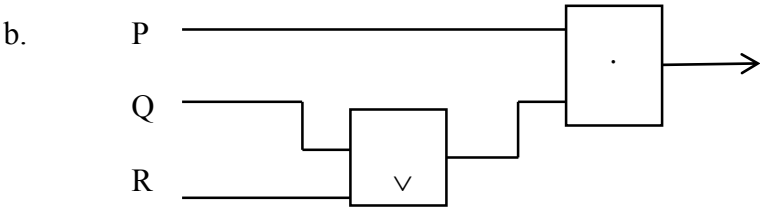
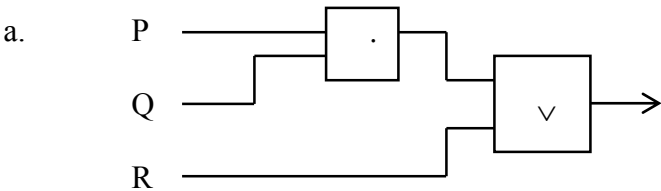

These diagrams make clear the order in which logical operators are to be applied in order to produce an unambiguous propositional form.

4.I.5. Exercises: Draw the logic gate diagrams for H2 and H3.

For each row of a truth table, we can take the truth-values of the atomic propositions as inputs and the truth-value of the compound as output. The truth tables can then be represented as follows:

<u>Input</u>			
1	2	3	4
T	T	F	F
T	F	T	F

<u>Output</u>			
1	2	3	4
T	F	F	F

1	2	3	4
T	T	F	F
T	F	T	F

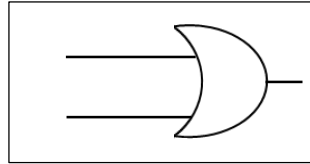

1	2	3	4
T	T	T	F

1	2	3	4
T	F		

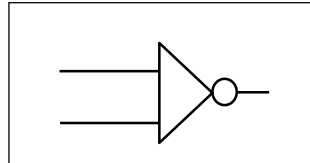

1	2	3	4
F	T		

If we adopt the convention of representing T by 1 and F by 0, then we can present the input-output function of series, parallel, and inverted circuits as follows:

Input			
1	2	3	4
1	1	0	0
1	0	1	0

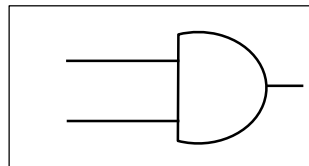

Output			
1	2	3	4
1	0	0	0

1	2	3	4
1	1	0	0
1	0	1	0

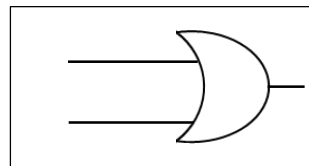

1	2	3	4
1	1	1	0

1	2	3	4
1	0		

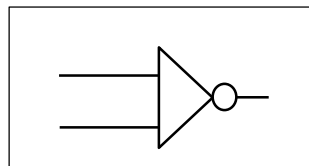

1	2	3	4
0	1		

By replacing the decimal representation of numbers with the binary representation of numbers, we are able to use the circuit analogues of the logical connectives to add, subtract, and multiply. Thus, inputs to the 'or' gate give outputs that are equivalent to the mathematical operation of

addition (when a carry register is incorporated). And inputs to the ‘and’ gate give outputs that are equivalent to the mathematical operation of multiplication.

By replacing the decimal representation of numbers with the binary representation of numbers, we are able to use the circuit analogues of the logical connectives to add, subtract, and multiply.

Thus, inputs to the ‘or’ gate give outputs that are equivalent to the mathematical operation of addition (when a carry register is incorporated). And inputs to the ‘and’ gate give outputs that are equivalent to the mathematical operation of multiplication.

Diagram Summaries:

Circuit Diagrams:

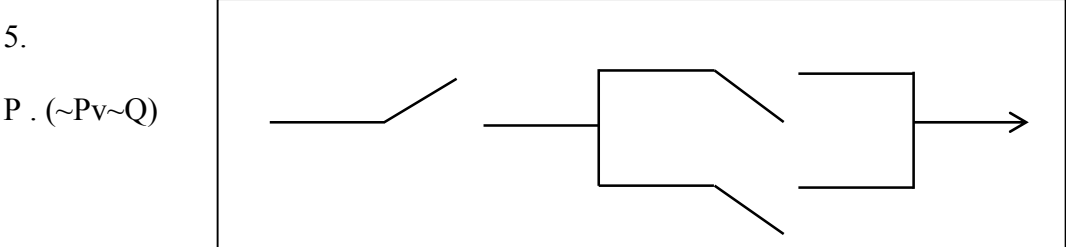
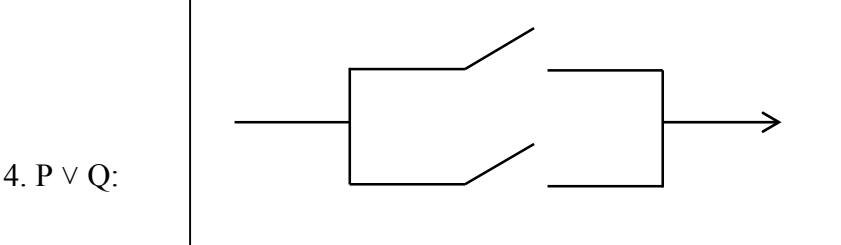
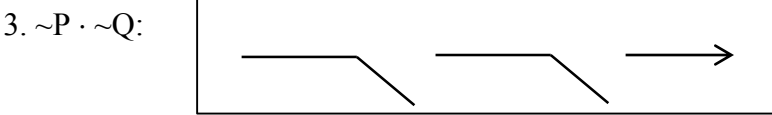
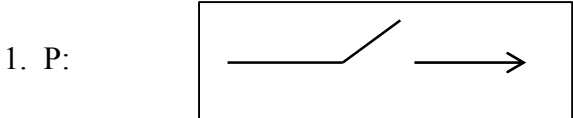

i) $\sim P$: Logic Diagram:

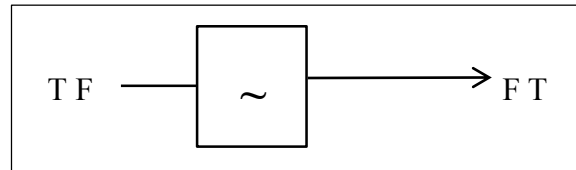

Gate Diagram:

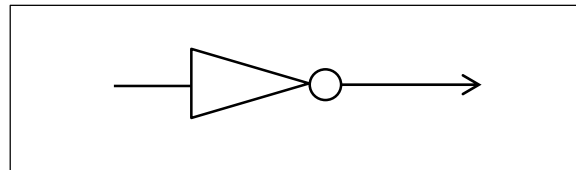

ii) $P \cdot Q$: Logic Diagram:

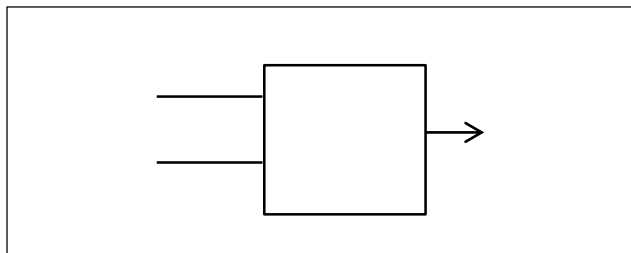

Gate Diagram:

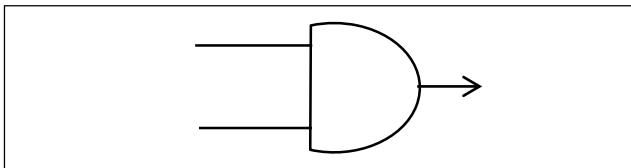

iii) $P \vee Q$: Logic Diagram:

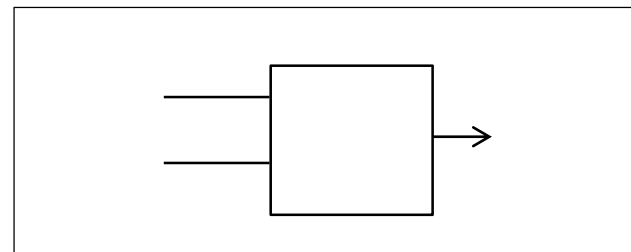

Gate Diagram:

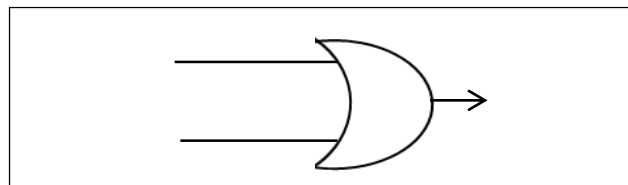

Write out the output for $P \cdot (\sim P \vee \sim Q)$:

Logic Diagram:

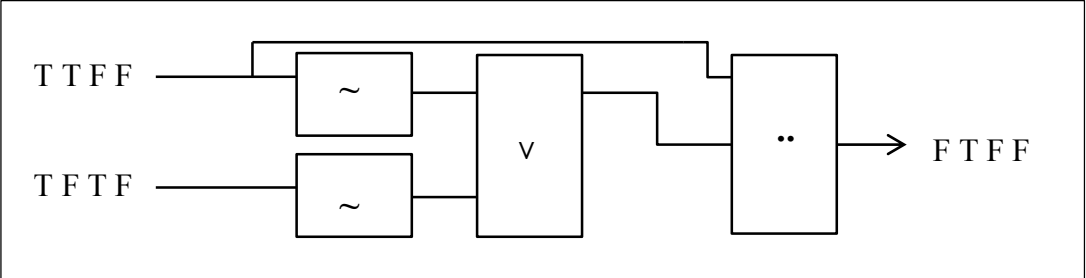

Gate Diagram:

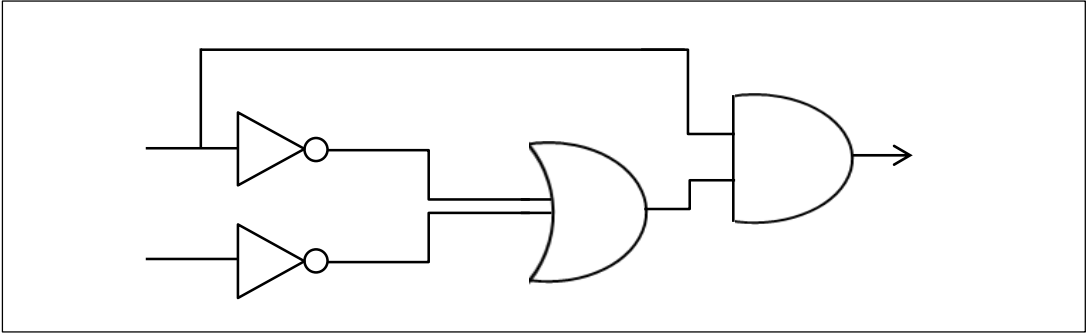

Computer chips combine binary number inputs and produce binary number outputs in accordance with the logical operations of negation, disjunction, and conjunction.

4.I.4. Exercises: For each of the following propositional forms, (a) draw its logic diagram; (b) construct its DNF; (c) draw the circuit diagram for the DNF; (d) draw the gate diagram for the DNF.

1. $\sim(p \cdot q)$
2. $(p \vee q) \cdot \sim p$
3. $(p \cdot q) \vee \sim q$
4. $p \supset q) \vee (p \cdot q)$
5. $(p \cdot q) \cdot \sim p$
6. $(p \supset q) \vee (q \supset p)$

Logic and Probability

While this text has focused primarily on deductive arguments, it is important to recognize that not all arguments are deductive. Some arguments are inductive. But, unlike deductive arguments, an acceptable *inductive* argument is not one where the truth of the premises guarantees the truth of the conclusion. Rather, an acceptable inductive argument is one where the truth of the premises makes the truth of the conclusion more or less probable.

Propositional and predicate logic shows how, from the truth values assigned to constituent simple statements, the truth-value of compound statements formed from them can be calculated. Probabilistic logic supplements truth-functional logic by showing how statements that are only probably true can be combined into compounds whose subsequent probabilities can be calculated. It provides us with a way of defining probabilities, a way of combining probability statements, and a way of calculating the probability of compound statements. The modern theory of probability provides the foundation of inductive logic.

A. PROBABILISTIC INFERENCE

I. The Modern Theory of Probability

From time immemorial, human beings have attempted to benefit themselves by taking risks, hoping to succeed where others may have failed. Businessmen, traders, gamblers, and lovers are known for taking chances on uncertain outcomes. But while lovers typically do not act rationally, businessmen and serious gamblers do. And being rational means making choices that have the highest expectation of success and avoiding choices that have the lowest expectation of success.

Gamblers are particularly shrewd observers of games of chance where wealth is wagered, won, and lost. Much of the modern analysis of chance and probability comes from the observations and conjectures of gamblers, many of whom appealed to contemporary mathematicians for help in deciding what bets to make and what bets to avoid. In the 13th century, King Alfonso of Castile (1221-1284) produced seven treatises on dice and other games of chance. In the 16th century, Girolamo Cardano (1501-1576) wrote *Liber de Ludo Aleae* (*The Book on Games of Chances*), one of the first written outlines of modern probability.³ Cardano's aim was to show how to calculate the probability of outcomes in games of chance so that bettors truly had equal chances of winning. Cardano's cryptic remarks prefigure what became the mathematical theory of probability where the probability of E, $\Pr(E)$, is defined as follows:

³ Cardano was one of the most famous physicians of his age, but he was also a gambling addict, as were many of the aristocracy. He confessed to "immoderate devotion to table games and dice....During many years I have played not off and on but, as I am ashamed to say, every day." Bernstein, Peter L. *Against the Gods: The Remarkable Story of Risk*. New York: John Wiley & Sons, 1996. Print. p. 45

Let $n(\mathbf{G})$ = the total number of outcomes in the game;

$n(\mathbf{E})$ = the total number of outcomes in the game that are E.

Then, if each outcome is equally likely,

$$\mathbf{Pr}(\mathbf{E}) = n(\mathbf{E}) / n(\mathbf{G}).$$

In the mathematical theory of probability, **the probability of an event E in game G** is the number of outcomes describable as E, divided by the total number of possible outcomes in G. In other words, the probability that E is true, $\text{Pr}(\mathbf{E})$, is based on the proportion of events in our universe of discourse G that are E events. $\text{Pr}(\mathbf{E})$ can range from a value of zero, which means there is total certainty that E will be false; to a value of one, which means that there is total certainty that E will be true. This is expressed as $0 \leq \text{Pr}(\mathbf{E}) \leq 1$.

It may seem paradoxical that by using probabilities we can know what to expect, even when the outcome is a matter of chance. Flipping a coin is one model of choice by chance. There are 2 possible outcomes, H or T, and any flip produces either H up or T up, but not both. Thus,

$$\text{Pr}(\mathbf{H}) = \text{Pr}(\mathbf{T}) = 1/2$$

Suppose A bets B that the coin will land H up, and B accepts the bet. If the coin is randomly flipped, and lands H up, then A wins. (If the coin is randomly flipped, and lands T up, then B wins.) This is a **fair bet** because each participant had an equal chance of winning. If A were a wealthy merchant and B an impoverished beggar, we might be appalled at the justice of the wealthy person gaining at the expense of the poor person who loses, but the bet was fair.

[references to the ethics of gambling]

Throwing a die is another model of choice by chance. There are 6 possible outcomes, and any throw is either 1 or 2 or 3 or 4 or 5 or 6 (but not more than one of these):

$$\text{Pr}(1) = \text{Pr}(2) = \text{Pr}(3) = \text{Pr}(4) = \text{Pr}(5) = \text{Pr}(6) = 1/6$$

Each number on a die is either even or odd: E(2,4,6) or O(1,3,5). Thus, in throwing a single die, there are two kinds of outcome: even or odd number up, but not both:

$$\Pr(E) = \Pr(O) = 3/6 = 1/2$$

Drawing a card from a standard deck that has been shuffled is another model of choice by chance. A standard deck consists of 52 distinct cards divided into 4 kinds (suits). Therefore the probability of drawing any particular card is $1/52$:

$$\Pr(9H) = \Pr(6C) = \Pr(2D) = \Pr(7S) = 1/52.$$

There are 4 kinds of outcome: Heart (H), Diamond (D), Spade (S), or Club (C). Since each kind has 13 members,

$$\Pr(H) = \Pr(D) = \Pr(S) = \Pr(C) = 13/52 = 1/4$$

In each of the above examples, each kind of event has an equal chance of occurring. But there are other cases where the different kinds of events in the game may have different chances of occurring. An example would be a roulette wheel (urn of marbles), on which there are 10 (G)reen, 20 (W)hite, 30 (R)ed, and 40 (B)lack slots (marbles). This gives a total of 100 possibilities (slots,marbles). If we turn (shake) the wheel (urn) and randomly choose a slot (marble) on the wheel (from the urn), the probability of picking a slot (marble) with a certain kind of color would be:

$$\Pr(G) = 10/100 = 1/10$$

$$\Pr(W) = 20/100 = 2/10$$

$$\Pr(R) = 30/100 = 3/10$$

$$\Pr(B) = 40/100 = 4/10$$

Though each individual has an equal chance of being chosen, certain kinds of events are more likely than others.

In the example with cards, there are four kinds of cards, and each kind has thirteen instances. Thus, $\Pr(H) = \Pr(D) = \Pr(S) = \Pr(C) = 1/4$. But in the roulette wheel example, while there are four kinds of events, each kind has a different number of individual instances. Thus, $\Pr(R) \neq \Pr(W) \neq \Pr(B) \neq \Pr(G)$.

When multiple choices are made from the same deck, we must distinguish **choice with replacement** of the card chosen from **choice without replacement** of the card chosen. Thus, with a deck of 52 cards, $\Pr(8D) = 1/52$ and $\Pr(D) = 13/52 = 1/4$. If 8D is chosen, and replaced, then $\Pr(8d)$ remains $1/52$ and $\Pr(D) = 13/52 = 1/4$. But if 8D is not replaced, then on the next choice, $\Pr(8D) = 0$ and $\Pr(D) = 12/51$.

5.A.1. Probability Exercises for Games of Chance:

A. Assume we have 6 bananas, 7 oranges, 8 apples, and 9 peaches, each in a bag that is indistinguishable from the other bags. What is the probability that the bag you choose will have in it:

1. an orange?
2. an apple?
3. a peach?
4. a banana?

B. Assume we have 6 bananas, 7 oranges, 8 apples, and 9 peaches, each in a bag that is indistinguishable from the other bags. Calculate the probabilities under the conditions specified.

1. remove 2 banana bags only; $\Pr(b) =$
2. remove 3 apple bags only; $\Pr(a) =$
3. remove 4 orange bags only; $\Pr(o) =$
4. remove 5 peach bags only; $\Pr(p) =$
5. remove all bags with bananas. $\Pr(a) =$
6. remove all bags with peaches. $\Pr(a) =$

C. Remove 3H, 8H, 3C, 8C from a regular deck. What is:

1. $\Pr(8D) =$
2. $\Pr(8H) =$
3. $\Pr(H) =$
4. $\Pr(6H) =$
5. $\Pr(D) =$
6. $\Pr(6D) =$
7. $\Pr(C) =$
8. $\Pr(2C) =$
9. $\Pr(S) =$

D. Deck without wild card with wild card

1. $\Pr(5H) =$
2. $\Pr(H) =$
3. $\Pr(4D) =$
4. $\Pr(4) =$
5. $\Pr(KC) =$

(slot machines, lotteries, blackjack,)

II. The Relative Frequency Theory of Probability

The definition of probability we have developed using games can be extended to events that are not parts of a game. The probability of many kinds of events in everyday life, business, and science can be estimated using the frequency of past events to estimate the probability of similar events in the present and future. Suppose there were 10,000 auto accidents in City A over the last five years, and 9,000 of them involved drivers 20-30 yrs. old, 800 between 30-40, 100 between 40-50 yrs. old, 50 between 50-60 yrs. old, 30 between 60 -70 yrs. old, and 20 were > 70 yrs. old. We calculate the probabilities of Auto Accidents in A for each age group as follows:

- a. $\Pr(\text{AA}20-30) = 9,000/10,000 = 900/1000$
- b. $\Pr(\text{AA}30-40) = 800/10,000 = 80/1000$
- c. $\Pr(\text{AA}40-50) = 100/10,000 = 10/1000$
- d. $\Pr(\text{AA}50-60) = 50/10,000 = 5/1000$
- e. $\Pr(\text{AA}60-70) = 30/10,000 = 3/1000$
- f. $\Pr(\text{AA}>70) = 20/10,000 = 2/1000$

If city A in the next year is pretty much the same as city A in the previous years, and an automobile accident takes place in City A, it is highly probable that a 20-30 yr. old was involved, and highly unlikely that someone >70 was involved. If insurance company C1 has a high percentage of 20 yr. olds, then it should expect to pay more auto insurance claims than a company, C2, that has a higher percentage of 50 yr. olds. Accordingly, premiums or deductibles might have to be higher at firm C1 than at firm C2. Or, C1 may keep lower rates but introduce tougher requirements.

Fire insurance rates are determined in similar fashion. Suppose that for the last 10,000 accidental house fires, 8000 were in houses >70 yrs. old, 1000 were in houses 60-70 yrs. old, 800

were in houses 50-60 yrs. old, 100 were in houses 40-50 yrs. old, 50 in houses 30-40 yrs. old, 30 in houses 20-30 yrs. old, and 20 in houses <20 yrs. old.

Yrs. old	# fires	Probability of accidental house fire
a. < 20	20	20/10,000
b. 20-30	30	30/10,000
c. 30-40	50	50/10,000
d. 40-50	100	100/10,000
e. 50-60	800	800/10,000
f. 60-70	1000	1000/10,000
g. >70	8000	8000/10,000

If history has shown that older houses have a higher probability of catching fire, then premiums or deductibles on older houses are likely to be higher than those on more recently built houses.

The insurance company wagers that the total premiums they collect will exceed their total payouts for claims. The insurance company is not making a fair bet. The insurance company is making a bet where the odds are in it's favor, in order to produce a profit.

The above scenarios use a **relative frequency theory** of probability, where the probability of an event E is determined by the frequency with which E has occurred in the past, relative to the total number of all A cases:

$n(A)$ = number of all past outcomes of A;

$n(E)$ = number of past outcomes of A's that are E,

$\Pr(E) = n(E)/n(A)$

In estimating the relative frequency of A's that are E, $n(E)$, it is easy to be misled by the availability and vividness of the events we take notice of. There is, for instance, a tendency to overestimate the frequency of events that are described in personal terms, and underestimate the frequency of events described by impersonal statistical data. Despite the data that Yototas have the highest repair rate, Phyllis may believe Yototas are good cars because her cousin has one, and likes it a lot.

5.A.2. Probability Exercises for Relative Frequencies:

- 1) Let each sample consists of 10 consecutive flips. Record the relative frequencies of H and T in each sample.
- 2) Place a piece of clear tape on the H side. Record the relative frequencies in 10 throws.
- 3) In the last year (365 days) the precipitation was 70 days of (ra)in, 61 days of (sn)ow, 40 days of (sl)eeet, and 10 days of (ha)il. For that year, what was:
 - a) $\Pr(\text{Ra})$
 - b) $\Pr(\text{Sn})$
 - c) $\Pr(\text{Sl})$
 - d) $\Pr(\text{Ha})$

The modern theory of probability derives from using games to provide objective measures of what we should expect, based on the particular parameters of the game used (coins, dice, cards, roulette, ..). But in calculating relative frequencies, we are often called upon to give probability estimates of events that are not as well defined as the events within a game. To illustrate, determining whether a fire was accident or arson is not like determining whether two

dice fall showing snake-eyes⁴ or whether five cards are a flush (all of the same suit). Part of the problem in deciding what will be counted as an accidental fire is that the criteria for whether something is accidental or not has changed (witchcraft, sorcery, divine curse, lightning, electrical short circuit, spontaneous combustion). We are also sometimes called upon to give probability estimates of events that have not occurred in the past. Thus, how probable is it that a man will become pregnant and give birth to a child within the next 5 yrs., within the next 20 yrs., within the next 100 yrs.? Such estimates involve factors that often may differ from person to person.

⁴ (1,1)

III. Rules for Calculating Probabilities

Once the probabilities of our simple propositions have been determined, we can calculate the probabilities of compound propositions formed from them using the truth-functional connectives for negation, conjunction, and disjunction.

Negation Rule: $\Pr(\sim A) = 1 - \Pr(A)$

$$\Pr(A) = n(A) / n(G)$$

$$\Pr(\sim A) = n(\sim A) / n(G)$$

$$1 = n(A) + n(\sim A) / n(G) = n(A) / n(G) + n(\sim A) / n(G) = \Pr(A) + \Pr(\sim A)$$

Given $1 = \Pr(A) + \Pr(\sim A)$, the Negation Rule follows:

$$1 - \Pr(A) = \Pr(\sim A).$$

In throwing a white die, W, with six sides numbered 1 through 6, $\Pr(W2) = 1/6$. Thus,

$$\Pr(\sim W2) = 1 - \Pr(W2) = 1 - 1/6 = 5/6.$$

The **odds** that E will occur is the ratio of E events to $\sim E$ events:

$$\mathbf{O(E) = n(E) : n(\sim E)}$$

Since $n(G) = n(E) + n(\sim E)$, the odds tell us how often we can expect E events relative to $\sim E$ events. If $n(E)$ is greater than $n(\sim E)$, then betting on E is more likely to produce wins than betting on $\sim E$. On the other hand, if $n(E)$ is less than $n(\sim E)$, then betting on $\sim E$ is more likely to produce wins than bets on E. Thus, $O(W2) = 1:5$ and $O(\sim E) = 5:1$. When $n(E) \neq n(\sim E)$, payoffs have to be adjusted in order to make the bet fair.

5.A.3. Exercises on determining simple probabilities and odds with a deck of 52 cards:

1. J proposes to K: If you are dealt a Heart then I'll give you \$1. If you are not dealt a Heart, then you give me \$1. Is this a fair bet?

2. Without wild card:

a. $P(H) =$

b. $\Pr(\sim H) =$

c. $O(H:\sim H) =$

3. With 1 wild card:

a. $P(H) =$

b. $\Pr(\sim H) =$

c. $O(H:\sim H) =$

4. Suppose Joan receives \$1 each time she throws W2 and pays \$1 each time she does not throw W2 with a fair die. Is this a fair bet?

a. $\Pr(W2) =$

b. $\Pr(\sim W2) =$

c. $O(W2:\sim W2) =$

5. Drawing an ace from a standard deck of cards:

a. $\Pr(A) =$

b. $\Pr(\sim A) =$

c. $O(A:\sim A) =$

6. Suppose we are given 6 bananas, 7 oranges, 8 apples, and 9 peaches, each in a box that is indistinguishable from the other boxes. Determine the following values:

a. $\Pr(B) = \Pr(\sim B) = O(B: \sim B) =$

b. $\Pr(O) = \Pr(\sim O) = O(O: \sim O) =$

c. $\Pr(A) = \Pr(\sim A) = O(A: \sim A) =$

d. $\Pr(P) = \Pr(\sim P) = O(P: \sim P) =$

**Conjunction Rule: $\Pr(A \cdot B) = \Pr(A) \times \Pr(B)$
where A and B are independent events**

The probability of a conjunctive compound is the product of the probabilities of each conjunct, so long as the conjuncts are independent of one another. Two outcomes, A and B, are independent of one another if the occurrence of one has no influence on the occurrence of the other. We can illustrate this with the example of throwing a white die (W) and a black die (B).

Throws of the white die, W: W1, W2, W3, W4, W5, W6.

Throws of the black die, B: B1, B2, B3, B4, B5, B6.

The probability of throwing W2 is 1/6. The probability of throwing B5 is 1/6. Thus, the probability of throwing W2 and B5 is:

$$\Pr(W2 \cdot B5) = \Pr(W2) \times \Pr(B5) = 1/6 \times 1/6 = 1/36.$$

But this is only because the occurrence of W2 is independent of the occurrence of B5.

Many situations are such that what happens on one occasion can affect the probability of what happens subsequently. In a deck of cards, there are 13 hearts, 13 diamonds, 13 clubs, and 13 spades, giving a total of 52 cards. The probability of pulling a heart on the first draw is

$n(H)/n(\text{cards}) = 13/52$. However, the probability of pulling a heart on the second draw is $13/52$ if the first card was replaced, but is $13/51$ if the first card was not a heart and was not replaced; and is $12/51$ if the first card was a heart and was not replaced. Given two outcomes, if the first outcome, A, alters the probability of the second outcome, B, then A and B are not independent. In cases where A and B are events that are not independent, the Conjunction Rule as given above can not be applied, and must be expressed as follows:

Expanded Conjunction Rule: $\Pr(A \bullet B) = \Pr(A) \times \Pr(B \text{ given } A)$

Disjunction Rule:

$$\Pr(A \vee B) = \Pr(A) + \Pr(B)$$

where A and B are exclusive events

The probability of a disjunctive compound is the sum of the probabilities of each disjunct, so long as the disjuncts are exclusive. Recall that ‘v’ allows for inclusive disjuncts, where both disjuncts may be true. But the disjunction rule in probability is only applicable for exclusive disjuncts, where if one of the disjuncts is true, then all other disjuncts must be false.

Throwing a **single die** illustrates the application of the disjunction rule. A die (W) has six sides – W1, W2, W3, W4, W5, W6 – and they are mutually exclusive. If the die falls showing a particular number, it can show none of the other numbers on that throw. Thus, the probability that W will show a 2 or a 5 on a single throw is

$$\Pr(W2 \vee W5) = \Pr(W2) + \Pr(W5) = 1/6 + 1/6 = 1/3.$$

And the probability that a single die will show a 1 or 2 or 3 or 4 or 5 or 6 on a single throw is

$$\begin{aligned} \Pr(W1 \vee W2 \vee W3 \vee W4 \vee W5 \vee W6) &= \\ \Pr(W1) + \Pr(W2) + \Pr(W3) + \Pr(W4) + \Pr(W5) + \Pr(W6) &= \\ 1/6 + 1/6 + 1/6 + 1/6 + 1/6 + 1/6 &= 1 \end{aligned}$$

Now suppose we are throwing, not one, but **two dice**: one white and one black. Then all possible combinations are:

W1B1	W2B1	W3B1	W4B1	W5B1	W6B1
W1B2	W2B2	W3B2	W4B2	W5B2	W6B2
W1B3	W2B3	W3B3	W4B3	W5B3	W6B3
W1B4	W2B4	W3B4	W4B4	W5B4	W6B4
W1B5	W2B5	W3B5	W4B5	W5B5	W6B5
W1B6	W2B6	W3B6	W4B6	W5B6	W6B6

The probability of throwing a 2 with the white die or of throwing a 5 with the same die on a given throw is

$$\Pr(W2 \vee W5) = \Pr(W2) + \Pr(W5) = 1/6 + 1/6.$$

But the probability of throwing a 2 with the white die or of throwing a 5 with the black die is not

$$\Pr(W2 \vee B5) = \Pr(W2) + \Pr(B5) = 1/6 + 1/6.$$

This is because throwing W2 excludes the possibility of throwing W5 on that throw. But throwing W2 does not exclude the possibility of also throwing B5. Both W2 and B5 may occur on the same throw. W2 and W5 are exclusive. W2 and B5 are not exclusive.

In cases where A and B are not exclusive events, the disjunction rule is:

$$\text{Expanded Disjunction Rule: } \Pr(A \text{ or } B) = \Pr(A) + \Pr(B) - \Pr(A \cdot B)$$

Thus, the probability of W2 or B5 when throwing two dice is

$$\begin{aligned} \Pr(W2 \vee B5) &= \Pr(W2) + \Pr(B5) - \Pr(W2 \cdot B5) = \\ &(6/36 + 6/36) - [\Pr(W2) \times \Pr(B5)] = 12/36 - 1/36 = 11/36. \end{aligned}$$

Each of the 36 possible combinations of throwing two dice has an equal probability of occurring, which is 1/36. But when the outcomes of rolling 2 dice are grouped in terms of their sums, the probabilities of those sums are not equal.

Let the number of black and white pairs that sum to k be called $n(\text{sum } k)$. Then

$n(\text{sum } k)$ = the number of pairs that sum to k .

And the 36 combinations of throwing two dice produce sums from 2 through 12 are as follows:

Sum 2 = (W1,B1)

Sum 3 = (W1,B2), (W2,B1)

Sum 4 = (W1,B3), (W2,B2), (W3,B1)

Sum 5 = (W1,B4), (W2,B3), (W3,B2), (W4,B1)

Sum 6 = (W1,B5), (W2,B4), (W3,B3), (W4,B2), (W5,B1)

Sum 7 = (W1,B6), (W2,B5), (W3,B4), (W4,B3), (W5,B2), (W6,B1)

Sum 8 = (W6,B2), (W5,B3), (W4,B4), (W3,B5), (W2,B6)

Sum 9 = (W6,B3), (W5,B4), (W4,B5), (W3,B6)

Sum 10 = (W6,B4), (W5,B5), (W4,B6)

Sum 11 = (W6,B5), (W5,B6)

Sum 12 = (W6,B6)

If $n(\text{sum } k)$ = the number of B and W pairs that sum to k , then

$n(\text{sum } 2) = 1$ $n(\text{sum } 3) = 2$ $n(\text{sum } 4) = 3$ $n(\text{sum } 5) = 4$,

$n(\text{sum } 6) = 5$ $n(\text{sum } 7) = 6$ $n(\text{sum } 8) = 5$ $n(\text{sum } 9) = 4$,

$n(\text{sum } 10) = 3$ $n(\text{sum } 11) = 2$ $n(\text{sum } 12) = 1$.

Thus,

$$\Pr(\text{sum}2) = 1/36 \quad \Pr(\text{sum}3) = 2/36 \quad \Pr(\text{sum}4) = 3/36$$

$$\Pr(\text{sum}5) = 4/36 \quad \Pr(\text{sum}6) = 5/36 \quad \Pr(\text{sum}7) = 6/36$$

$$\Pr(\text{sum}8) = 5/36 \quad \Pr(\text{sum}9) = 4/36 \quad \Pr(\text{sum}10) = 3/36$$

$$\Pr(\text{sum}11) = 2/36 \quad \Pr(\text{sum}12) = 1/36$$

The probability of each individual outcome of rolling two dice is $1/36$. But the probabilities of the sums of the two dice are not equal. Thus, $\Pr(W2,B2)$ is different from $\Pr(\text{sum}4)$ because there is only one way for the two dice to simultaneously show a 2, but there are three ways that two dice can sum to 4: $(W1,B3)$, $(W2,B2)$, $(W3,B1)$. This is why an even money bet on rolling a $(2,2)$ is not as good as an even money bet on rolling a sum 4.

5.A.4. Exercises on negation, conjunction, disjunction:

1. What is the probability of getting at least one tail in three tosses of a coin?
2. Is an even money bet that you will not throw a 1 on any of three successive throws of a die a fair bet? Explain.
3. Calculate the Pr and odds when flipping 2 Coins:
 - a. $\Pr(HH) =$ $O(HH: \sim HH) =$
 - b. $\Pr(TT) =$ $O(TT: \sim TT) =$
 - c. $\Pr(TH) =$ $O(TH: \sim TH) =$
 - d. $\Pr(HT) =$ $O(HT: \sim HT) =$
4. Calculate the Pr and odds for throwing all combinations of 2 Dice.

5. $\text{Sum } 6 = (W1.B5) \vee (W2.B4) \vee (W3.B3) \vee (W4.B2) \vee (W5.B1)$

a. $\Pr(\text{Sum}6) =$

b. $O(\text{Sum } 6) =$

c. $\text{Sum } 7 =$

d. $\Pr(\text{sum}7) =$

e. $O(\text{sum}7) =$

6. Let $\text{sum } n_k = \text{sum } n \text{ on throw } k$. Thus, $\text{sum } 6_5 = \text{sum } 6 \text{ on throw five}$.

a. $\Pr(\text{sum } 6_1 \text{ or sum } 5_1 \text{ or sum } 4_1 \text{ or sum } 3_1) =$

b. $O(\text{sum } 6_1 \text{ or sum } 5_1 \text{ or sum } 4_1 \text{ or sum } 3_1) =$

c. $\Pr[(\text{sum } 6_1 \text{ and sum } 6_2) \text{ or } (\text{sum } 6_3 \text{ and sum } 6_4)] =$

d. $O[(\text{sum } 6_1 \text{ and sum } 6_2) \text{ or } (\text{sum } 6_3 \text{ and sum } 6_4)] =$

e. $\Pr(\text{sum } 6_1 \text{ and sum } 6_2) =$

f. $O(\text{sum } 6_1 \text{ and sum } 6_2) =$

g. $\Pr(\text{sum } 6_3 \text{ or sum } 6_4) =$

h. $O(\text{sum } 6_3 \text{ or sum } 6_4) =$

7. Assume a standard deck of cards is shuffled, without wild card and with replacement:

a. $\Pr(2 \text{ cards drawn of the same suit}) =$

b. $\Pr(3 \text{ cards drawn of the same suit}) =$

c. $\Pr(\text{ace high straight: five sequential cards with ace high}) =$

d. $\Pr(\text{flush: five cards of the same suit}) =$

8. Show why an even money bet on rolling a sum 4 is not as good as an even money bet on rolling a sum 7.

Origins of The Modern Theory of Probability

Around the year 1605, the founder of modern science, **Galileo Galilee**, was asked by his patron, the Grand Duke Cosmo II, for help in solving the following gambling problem:

“Three dice are thrown: ... long observation has made dice players consider (sum) ten to be more advantageous than (sum) nine. Why?”

Proceeding as Cardano had indicated, Galileo listed all the 6^3 (=216) possible combinations of 3 dice, and then listed those combinations that produce 9 when summed, and those combinations that produce 10 when summed. He showed that there were 25 combinations which summed to 9, and 27 combinations that summed to 10.⁵ Thus

$$\Pr(\text{sum } 9) = 25/216 \quad \Pr(\text{sum } 10) = 27/216.$$

In a circuit of 216 throws, 3 dice will sum 10 more often than they sum 9 (on the average), confirming the Grand Duke’s suspicion.

Another 17th century gambling enthusiast, the **Chevalier de Mere** (1607-1684), would bet even money that he could get at least one six in every four rolls of a die. This seemed counter-intuitive because we would expect, on the average, one six in every six throws of a die. Thus, de Mere was able to entice many to bet against him. But de Mere’s conjecture proved correct, and he won a considerable amount of money on the wager.

What is the probability that 6 will turn up in four throws of a six sided die? Let $6_1 = 6$ on throw 1 and $6_n = 6$ on throw n. Then it is tempting to represent this problem as follows:

$$\Pr(6_1 \text{ or } 6_2 \text{ or } 6_3 \text{ or } 6_4) = \Pr(6_1) + \Pr(6_2) + \Pr(6_3) + \Pr(6_4) =$$

$$1/6 + 1/6 + 1/6 + 1/6 = 4/6 = 2/3.$$

⁵ For 9, (1,2,6) appears 6 times, (1,3,5) appears 6 times, (1,4,4) appears 3 times, (2,2,5) appears 3 times, (2,3,4) appears 6 times, (3,3,3) appears 1 time. So throwing a total of 9 can appear 25 times in all; For 10, (1,3,6) appears 6 times, (1,4,5) appears 6 times, (2,4,4) appears 3 times, (2,2,6) appears 3 times, (2,3,5) appears 6 times, (3,3,4) appears 3 times. So throwing a total of 10 can appear 27 times in all. Therefore, the chance of throwing a total of 9 with three fair dice was less than that of throwing a total of 10.

This would lead us to expect the following:

$$\begin{aligned} \Pr(6_1 \text{ or } 6_2 \text{ or } 6_3 \text{ or } 6_4 \text{ or } 6_5 \text{ or } 6_6) &= \\ \Pr(6_1) + \Pr(6_2) + \Pr(6_3) + \Pr(6_4) + \Pr(6_5) + \Pr(6_6) &= \\ 1/6 + 1/6 + 1/6 + 1/6 + 1/6 + 1/6 &= 1 \end{aligned}$$

On this line of reasoning, we are certain to get 6 in six throws of a die, and more than certain to get it in seven throws. Using the Disjunction Rule in this way commits the fallacy of treating the constituent events as if they were mutually exclusive when they are not. Representing the problem as $\Pr [(6_1) \text{ or } (6_2) \text{ or } (6_3) \text{ or } (6_4)]$ hides the fact that each of these alternatives could be true. They are not exclusive alternatives.

The problem is correctly represented by asking for the probability of not getting a 6 in either of the four throws. Using the Negation Rule $\Pr (A) + \Pr (\sim A) = 1$, it follows that

$\Pr (A) = 1 - \Pr (\sim A)$. Thus, the probability of getting a 6 in four throws is one minus the probability of not getting a 6 on throw 1 or on throw 2 or on throw 3 or on throw 4:

$$\Pr (6 \text{ in } 4 \text{ throws}) = 1 - \Pr \sim(6 \text{ in } 4 \text{ throws}) = 1 - \Pr (\sim 6_1 \cdot \sim 6_2 \cdot \sim 6_3 \cdot \sim 6_4).$$

Since $(\sim 6_1)$, $(\sim 6_2)$, $(\sim 6_3)$, and $(\sim 6_4)$ are independent events, using the Conjunction Rule we get:

$$\begin{aligned} 1 - \Pr (\sim 6_1 \cdot \sim 6_2 \cdot \sim 6_3 \cdot \sim 6_4) &= 1 - [\Pr (\sim 6_1) \times \Pr (\sim 6_2) \times \Pr (\sim 6_3) \times \Pr (\sim 6_4)] = \\ 1 - \{5/6 \times 5/6 \times 5/6 \times 5/6\} &= 1 - 625/1296 = 1296/1296 - 625/1296 = 671/1296 \end{aligned}$$

It follows that in betting even money on 6 in four throws, the Chevalier de Mere could, on the average, expect to win 671 times and lose 625 times in a circuit of $6^4 (=1296)$ throws. The odds of throwing a 6 in four throws are 671: 625, slightly in favor of the Chevalier. But because this occurs only on the average over every 1296 throws, it is unlikely to be detected by the casual observer. Yet, this slight advantage in the odds gave the Chevalier a respectable 7% profit on the wager.

Cardano began his inquiries with the ethics of gambling in order to determine when a bet was fair. In the modern theory of probability a fair bet is one in which the odds of winning are equal to the odds of losing. But the Chevalier was not looking to make a fair bet. He, like most gamblers, wanted a bet where the odds were in his favor, but not noticeably so. In such cases, most losers tend to be unaware of the true source of their losses, and instead blame their bad luck on a spiritual affliction of some sort. Many seek a remedy through charms and prayers, instead of through a rational appraisal of the odds. When the Chevalier lost money on a similar bet he sought an explanation from the mathematician Fermat.⁶ Fermat in turn involved the mathematician Blasé Pascal, and together they introduced the basis for the modern theory of probability.

5.A.5. Exercises:

1. $\text{Pr}(6 \text{ in } 2 \text{ throws}) =$
2. $\text{Pr}(6 \text{ in } 3 \text{ throws}) =$
3. $\text{Pr}(6 \text{ in } 5 \text{ throws}) =$
4. $\text{Pr}(6 \text{ in } 6 \text{ throws}) =$
5. What is the probability of getting heads each time in three throws of a coin?
6. What is the probability of rolling two dice such that they sum three in each of three consecutive throws?
7. Out of 36 possible combinations of a pair of dice, only one, W6B6, gives a sum of 12. So we would expect a pair of dice to sum twelve once in every thirty-six throws. The Chevalier bet he could throw (6,6) in every twenty-four throws. Is this a good bet?
8. What are the odds that 2 will show in three throws of a 6-sided die? [Cardano could expect to win (on the average) 91 times and lose 125 times for every circuit of 216 throws.]

⁶ One would expect that (6,6) would occur only once in every 36 throws of two dice.

9. There are ten balls in a bag. 7 are Green and 3 are Blue. Jane is blindfolded, the bag is thoroughly shaken, and Jane draws a ball without looking. What is the probability that the ball will be: B? G?
10. Two dice are thrown. What are the odds that: (a) the tops of the two thrown dice sum 2; or (b) the tops of the two thrown dice sum 6.
11. Jonita has flipped a fair coin three times, and each time it has come up heads. What are the odds that the coin will come up heads on the next flip?

Risk is a measure of the **expected value** of different options. It allows us to compare the harm or benefit that might result from different choices. Risk analysis helps make clear how certain kinds of options are likely to be more beneficial than harmful. Let $\Pr(A)$ = probability of A and $V(A)$ = value of A. Then **the Expected Value, EV, of A is**

$$EV(A) = \Pr(A) \times V(A). \quad ^7$$

Suppose, on a scale of 0 to 100, the value of a benign accident is $V(A) = 0$ while the value of a fatal accident is $V(A) = 100$. Then the value of a fatal accident using motorcycle $V(A_m) =$ value of fatal accident using auto $V(A_a) =$ value of fatal accident using public transport $V(A_p) = 100$. But if the relative frequency of fatal accidents are $\Pr(A_m) = 20/1000$, $\Pr(A_a) = 10/1000$, and $\Pr(A_p) = 5/1000$, then

$$EV(A_m) = 2/100 \times 100 = 2$$

$$EV(A_a) = 1/100 \times 100 = 1$$

$$EV(A_p) = 1/200 \times 100 = .5$$

This shows that, based on the relative frequencies given, the risk of a fatal accident using a motorcycle is twice that using an auto and four times that using public transport.

⁷ See *Against the Gods: The Remarkable Story of Risk* by Peter Bernstein, p.103. see also *Risk and Rationality* by K.S.Shrader-Frechette, chpt.10. *Calculated Risks* by J.Rodricks, chpt. 10.

We take risks in order to obtain benefits we otherwise might not get. For the benefit of a regular salary, we accept the increased risk of an accident traveling to work. For the benefit of a warm house in the winter, we risk our house catching fire. For the benefit of vegetables and fruits during the winter, we increase our risk of botulism poisoning. For the benefits of increased industrialization, we increase our risks from exposure to chemical, biological, and mechanical hazards. We may buy insurance in order to guard against the exceptional losses that certain risks entail, but it is impossible to insure against all risks.

We also take risks to avoid certain harms we otherwise might suffer. We buy automobile insurance in order to avoid losses from car accidents. But the possibility of being harmed is perceived and evaluated differently by different individuals. Some people are risk-averse, and prefer to avoid losses rather than acquire benefits. Some people are risk-takers, and are prepared to suffer a loss in exchange for the opportunity to gain something they value. Some people are calculative, and prefer to take only risks that give them the highest odds of winning. One person might decline the opportunity for a great benefit in order to avoid the slightest risk to their family. Another might take great risks in order to provide benefit for their family. There is no one way that all people value their experiences, assign probabilities, and take risks.

The mathematical theory of probability derives from games in which there are a finite number of clearly specifiable outcomes. Thus, the probability of drawing a spade from a regular deck of playing cards is $\frac{1}{4}$, because there are 52 cards total, and 13 spades: $\frac{13}{52} = \frac{1}{4}$. But relative frequencies are not as clear-cut as features of games. Determining the probability that a particular house fire was accident or arson is in many cases a matter of contention. Likewise, deciding whether (publicly provided) bikes will count as public transportation may be contentious. And this will in turn affect the probabilities we assign.

The features of real life are often not as well-defined as features of a game. There is not always one right way to describe real life events that objectively determines their probability. This makes it difficult to identify all the different outcomes there are, estimate the probability of the different outcomes identified, and rank how important those outcomes are for the decision maker. There may be no one right way of estimating a real-life event's probability. But for any particular set of assumptions that we do make, the logic of probability provides us with a way to estimate the likelihood of the more complex events that derive from those assumptions. The modern theory of probability provides us with a way of exploring the value of different assumptions so that we can avoid bad bets, losing investments, and faulty inferences.

CHAPTER 6:
INDUCTIVE LOGIC

A. Inductive Inferences

I. Inductive Generalizations

When we use the information provided by a few instances of a certain kind to draw conclusions about all instances of that kind, we are making a generalization. When we use statistical information provided by a sample to draw statistical conclusions about the population as a whole, we are making a statistical generalization. Thus, if I think that most people won't like x because most of the people in my family don't like x, I am making a claim about most people, based on the sample of people in my family: "I know most people don't like hot spicy food because most of the people in my family don't like hot spicy food." This example illustrates two of the major sources of invalidity for inductive generalizations: (a) generalizing from samples that are too small; and (b) generalizing from samples that are biased.

(a) Suppose there are twenty marbles in a bag. And, after shaking the bag and drawing from it without looking, the first marble withdrawn is red. If I conclude that the rest of the marbles in the bag are red, then I am making a hasty generalization, based on a sample that is too small.

Suppose I continue to draw marbles without looking, and the second is red, the third is red, and the fourth and fifth are red. The evidence provided by these five draws makes the conclusion that all twenty of the marbles in the bag are red more probable.

Each random draw without looking increases the probability that all the marbles in the bag are red.

Suppose further that five more marbles are drawn, and all are red, but the marbles drawn were picked because they were red. This additional evidence would not increase the probability that all the marbles in the bag are red as much as the first five choices because the additional evidence is chosen to support the claim that all the marbles are red, whether that claim is true or false.

Following are examples of fallacies resulting from samples that are too small:

1. Three of my friends had lunch at the Princess Restaurant and said they liked it. It seems that everybody who goes there seems to like it.
2. Mary met a very charming man who was French. Thereafter, she was convinced that all Frenchmen were charming.
3. I know that all twenty year olds like to dance because I have five twenty year old friends and each one likes to dance.
4. President Richard Nixon and Vice-president Spiro Agnew deceived the American people, and that shows us that all Washington politicians are inherently deceitful.
5. Bill Clinton and Elliot Spitzer were unfaithful while in public office. That shows us what you can expect of Democrats.
6. John Mason is very aggressive. Maybe the rest of his family is like that too.

Often, one particular case is presented as representative of all similar cases. And with some kinds of things, one instance is like every other instance. Thus, the atomic weight of one gram of pure gold is going to be the same for every other gram of pure gold. And we expect one 16 oz. bottle of Coke to be like all other 16 oz. bottles of coke. With such kinds of things, we can generalize from a single instance to all instances of the

same kind. A conclusion about the population as a whole can be drawn on the basis of a small sample when diversity within the population is small.

But, in diverse populations, what is true of one instance need not be true of all instances of like kind. In such cases, when we generalize from a single instance or a small sample, we generalize hastily and should be prepared to revise our conclusions. Thus, some Frenchmen may be charming, but some may also be rude. Some twenty year olds may love to dance, but some may not. When there is a great deal of diversity within a population, a conclusion about the population as a whole cannot be drawn on the basis of a small sample. In statistics, the standard deviation is a measure of how much diversity there is between the members of a population, and is used in determining the size a sample must have in order to make valid inferences about that population.

Inductive generalizations are also fallacious if they are inferred from samples that are biased, whether the bias is intentional or unintentional. Thus, the grocer who arranges bags of fruit with the unblemished fruit on the top and the blemished fruit on the bottom of the bag may be intentionally misleading the unwary customer. On the other hand, prosecutors may sincerely believe the sample of the evidence they have collected leads to a clear conclusion. Consider the following example: (i) Mr. A's boss, Mr. B, has been found murdered at his home, (ii) Mr. A was the last person seen leaving Mr. B's home on the night of the murder, and (iii) Mr. A had been fired the day before and was quite upset over the loss of his job. Does this lead to the conclusion that Mr. A committed the murder? Not necessarily. The information presented makes it probable that Mr. A committed the murder, and that is why investigators are justified in holding Mr. A suspect. But there may be additional information that might decrease the probability that

Mr. A committed the murder. For instance, additional evidence might show that Mr. A was miles from the scene at the time of the murder. The sample of evidence presented by the prosecution need not be all of the relevant evidence. When evidence that supports a claim is counted and evidence that denies it is discounted or ignored, the evidence is treated in a biased manner.

In our personal lives, we are prone to use samples that are familiar and accessible in order to infer conclusions about the population the sample is taken to represent. (examples needed) Given the ever-present possibility of biased sampling (intentional and unintentional), procedures have been developed to insure that bias in the selection of the sample is minimized. This typically involves using a randomizing procedure for choosing the sample that eliminates many common sources of bias (e.g., stirring the soup thoroughly before tasting it, calling a coin before flipping it; rolling the dice rather than sliding them; shuffling the deck before dealing a card, etc.).

In order to validly infer that what is true of the sample is true of the population as a whole, the sample must be representative of the population as a whole, rather than representative of one person's predilections and preferences. Since our choices can be influenced in subtle ways, we must be vigilant to ensure that the generalizations we accept are not based on evidence that is hasty, biased or both.

5.B.1. Exercises (more needed) on inductive generalizations:

1. Ten dead bats were submitted to Wildlife Services. Five were rabid. Can we therefore expect that 50% of all bats are rabid.
2. Women talk more than men. I know this because my mother talks more than my father.
3. My neighbor solved my plumbing problem. He is probably good at solving math problems as well.
4. We prayed before the game, and we won. That proves that if a team wants to win then that team has got to pray for it.
5. The last two Sundays have been beautiful. We should expect every Sunday to be a beautiful day.
6. In a random sample of homeowners, 50% were against higher real estate taxes. Therefore, we can expect 50% of voters will oppose legislation for higher real estate taxes.
7. This sample of gold has a boiling point of 267c. Therefore all gold has a boiling point of 267c.

II. Inductive Instantiation

In inductive instantiations, general information about a group is used to draw conclusions about an individual member of the group.

Examples:

1. Most boys like to play soccer. Jose is a boy. Therefore Jose probably likes to play soccer.
2. Most boys don't like to play with dolls. Jose is a boy. Therefore, Jose probably does not like to play with dolls.
3. Most girls like to play with dolls. Maria is a girl. Therefore Maria probably likes to play with dolls.
4. Most girls don't like to play violent video games. Maria is a girl. Therefore Maria probably does not like to play violent video games.

These examples use widely held preconception about boys and girls in order to infer information about Jose and Maria. We tend to categorize individuals in terms of the preconceptions we have accepted without critical appraisal. Those preconceptions reflect the kinds of things we believe exist and implies we can expect of such things. Typically the preconceptions we use are not explicitly stated, and often a conclusion may be drawn about a current situation on the basis of faulty generalizations.

Because the generalizations that are incorporated into our preconceptions are typically not stated explicitly, the arguments they are used in take the form of enthymemes. Recall that an enthymeme is an incomplete argument where either a premise or the conclusion is unstated. Thus, the above examples might be phrased as enthymemes as follows:

1. Jose is a boy. Therefore Jose probably likes to play soccer.
2. Jose is a boy, so Jose probably doesn't like to play with dolls.
3. Maria is a girl and we know what girls like to play with dolls, don't we.
4. Maria is a girl, so she probably doesn't like to play violent video games.

When an argument is given with a missing premise, the speaker is able to avoid openly stating and asserting the missing generalization. Instead, the speaker leaves it up to the listener to supply the missing premise and its assumption of truth. When an argument is given with a missing conclusion, the speaker can avoid explicitly endorsing the conclusion. Instead, it is left to the listener to infer the conclusion, which may be implied but unstated.

Sometimes, it may be necessary to act on unexamined preconceptions. If Mary is walking through the grass and sees a long slender figure lying ahead, she may become

frightened and wary of proceeding further. If the long slender figure remains straight and unchanging, she might re-evaluate her reaction that it might be a reptile. But if the figure appears to move, she would be confirmed in her belief that it might be a reptile. Mary's initial preconception that the figure is a reptile would should be critically appraised on the basis of relevant information.

Likewise, if Mary has had no personal encounter with pit-bulls and only knows of them through reputation, then she might hesitate to continue forward if she sees one approaching her. But suppose Mary is assured by all concerned that the pit-bull is old, arthritic, and a pet for children in a nursery school. If she continues to act as if this pit-bull is likely to violently assault her, then she has a preconception of a pit-bull that is resistant to further information.

A stereotype is a preconception that is resistant to modification on the basis of relevant information. If Mary is afraid of pit bulls, her preconception that pit bulls are violent may benefit her by making her cautious around them. But if she ignores additional information showing that a particular pit-bull is highly unlikely to be violent, then her concept of a pit-bull is fixed and rigid. If all one knows is that Jose is a boy, it might be reasonable to assume that he probably likes to play soccer, because many boys do like to play soccer. But if we learn subsequently that Jose has been paraplegic from birth, it may be unreasonable to claim that Jose would still probably like to play soccer.

Many stereotypes have evolved as historical tools of oppression, when individuals were forced to conform to society's prior preconceptions about them. Women and people of color were considered to be naturally subservient, and this subservience was coerced under threat of violence. Though a person may have little choice about which

preconceptions they have inherited from the past, they do have a moral obligation to examine those preconceptions in the face of contrary evidence. Many preconceptions escape attention because they remain unstated. Articulating and critically examining preconceptions is the best antidote to stereotyped behavior. Being rational requires being open to new information that may lead us to alter our preconceptions, no matter how we may have acquired them.

5.B.3. Exercises (editing needed) on inductive syllogisms:

For each of the following, complete the enthymeme by identifying the generalization that is unstated. Provide (a) additional information that increases and (b) additional information that decreases the probability that the generalization is applicable:

1. John is Jewish. So John probably likes money.
2. Ben Carson is a successful African-American neuro-surgeon. He is also probably a good athlete.
3. Alice Walker is a successful African-American writer. But we can be certain that Alice probably still loves fried chicken.
4. Hector is an 88 yr. old Afro-Cuban male. But Hector probably still loves to dance.
5. Jamaal is African-American and Phillip is European-American. So Phillip probably has a higher IQ than Jamaal.
6. Mr. and Mrs. Gonzalez own a highly successful business. But I'll bet that Mr. and Mrs. Gonzalez still have a large family.
7. Jim is Native American. So he probably receives income from casino gambling.
8. Mary Wong is Japanese. So she is probably docile and submissive to her husband.
9. Cornel West is a contemporary African American philosopher. So it is likely that he has a criminal past.
10. Mary has been unmarried all her life. That is probably why Mary is unhappy.

11. Phyllis is majoring in physics. But it is likely that Phyllis will give up when the math becomes really difficult.
12. I have encouraged my daughter to follow her natural inclinations and be a wonderful mother for children she can be proud of.
13. Mary is probably weaker than Mike because that's how women and men usually are.
14. My wife is more emotional than me because that's how men and women usually are.
15. Toni is HIV positive. (S)He is probably homosexual.
16. Toni is homosexual, so (s)he is probably HIV positive.
17. Jim is Irish, so he probably loves to drink and fight.
18. K is driving a Mercedes so K must be wealthy.
19. B graduated from Smith College, so B is probably a feminist.
20. D is a computer scientist, so D is probably horrible at sports.
21. Z is a doctor, so Z must know CPR.
22. I saw K buying a cake. So K must love sweets.
23. My German Shepard was very easy to train, so I'm sure your German Shepard will be housebroken in no time.

III. Analogical Inference

Some inductive arguments involve reasoning by analogy, where the properties of one instance are used to infer what properties a similar instance will have. Reasoning by analogy proceeds from one instance, X, to another instance, Y (without necessarily generalizing) and has the following form:

Primary analogue:	X has properties a, b, c, d, e;
Secondary analogue:	Y has properties a, b, c, d;
Therefore, probably	Y has property e.

Examples:

1. At time t_1 I ate mushrooms and I got sick. Therefore, if I eat mushrooms at time t_2 , then I will probably get sick.
2. When X pet dog₁, it bit X. Therefore, if Y pets dog₁, the dog will probably bite Y.
3. X purchased a Yotota and was very pleased with its performance. Therefore if Y purchases a Yotota, then Y will probably be pleased with its performance.
4. When water was poured on a campfire, the fire went out. Therefore, if we pour water on this grease fire, the fire will go out.
5. X appears, and has on white shoes, a white suit, and a white tie. Y appears, and has on white shoes and a white suit. His back is to us, however, and we can't see the color of his tie. But it will probably be white.

Things, persons, and groups are often described in analogical terms as a way of undermining or inflating their value. Thus, if B is described as strong as an ox, we might easily conclude that B is also probably as dumb as an ox. But if B is described as strong as a lion, we are more likely to conclude that B is probably as brave as a lion, as well.

When the aim is to oppress a group, that group is often characterized as analogous to

non-human animals we detest. But when the aim is to valorize a group, they are described as analogues of animals we admire.

1. The T are like the cockroaches in our homes. We would kill the cockroaches. We should kill the T.
2. The Js in our country are like rats in our neighborhoods. We exterminate rats. We should exterminate the Js.
3. B people are like dangerous animals. We need to keep them locked up for our protection.

In reasoning by analogy, we infer that Y has property e because Y shares properties a, b, c, and d with X, and X has property e. An analogy is strong if the presence of a,b,c, and d makes the presence of e more probable. But an analogy is weak if the presence of a,b,c, and d does not make the presence of e more probable. Thus, knowing the manufacturer of a car is relevant to inferences about whether the car will perform well. But knowing the color of a car neither increases nor decreases the probability that the car will perform well. We base our expectations on a weak analogy if we expect the color and trim of Y's car to be relevant to the performance of Y's car. And though the logo of a car may have no causal relationship to the mechanical functions of the car, companies go to great lengths to insure that their logo is a reliable indicator of the mechanical quality of the car.

X is in a red and white bottle and X tastes great. Y is in a similar red and white bottle. Therefore, Y will taste great as well.

On the other hand, relevant dissimilarities between X and Y decrease the probability that what is true of X will also be true of Y. In such cases, though there are similarities between X and Y, there are also relevant dis-similarities between X and Y that make the analogical inference faulty.

1. If J was tired at time t_1 when she ate mushrooms and got sick and J is not tired at time t_2 when she eats mushrooms, then the probability that she will get sick at time t_2 may be less than it was at time t_1 .
2. If dog₁ was eating when X pet it at time t_1 , and dog₁ is not eating when X pets it at time t_2 , then the probability that the dog will bite X at time t_2 may be less than it was at time t_1 .
3. If X purchased a Yotota sedan and Y purchases a Yotota truck, what holds true for the sedans may not hold true for the trucks.
4. Mary is a human and Mary can become pregnant. Tom is a human. Therefore Tom can become pregnant.

In law, the primary analogue X is called the precedent. In legal litigation, one party attempts to show that a current case, Y, is similar in all relevant respects to a precedent, X, and should be decided as the precedent was decided. The other party attempts to show that Y is not similar in all relevant respects to X, and should be decided in a manner contrary to the decision in X. Similar cases should receive similar treatment under the law, but dissimilar cases may require different treatments. Many legal controversies hinge on how the primary analogue is framed.

Examples:

1. A fetus is similar in all important respects to a child. Therefore, abortion is like killing an innocent child and is a form of murder.
2. A fetus is growing tissue that is not yet a child. Therefore abortion is not like murder.
3. A mother who takes drugs while pregnant is guilty of child-abuse.
4. A mother who takes drugs while pregnant is guilty of self-abuse.

There are correct and incorrect uses of the argument from analogy.

Strong Analogies:

1. Housecats are felines and have whiskers. Lions are felines. Therefore, lions probably have whiskers.
2. A home is like a castle. A castle is a place where you should feel secure. So, a home is a place where you should feel secure.

Weak Analogies:

1. Housecats are felines and need protection from large vicious dogs. Lions are felines. Therefore, lions need protection from large vicious dogs.
2. A home is like your castle. A castle has guards and a moat. Therefore, I should build a moat around my house and hire guards for protection.
3. Water is a liquid and pouring water on the fire extinguished it. Oil is a liquid. So, pouring oil on the fire will probably extinguish it.
4. Men in power have often coerced sexual favors from women subordinates. Women will probably do the same thing to men subordinates when they gain power.

5.C.1. Exercises (more needed):

A. For each of the following, determine if the analogy is weak or strong:

1. Human beings and watches are similar in that they are all finely structured. Watches do not evolve from random combinations of glass and steel, and by analogy, human beings do not evolve from the random combination of cells and tissues.
2. Electrons revolve around the nucleus just like planets revolve around the sun. By analogy, electrons must be attracted to the nucleus because of gravity.
3. Mars and Earth both orbit around the sun, and they both have satellites. Since life exists on earth, it is reasonable to predict that life exists on Mars as well.

B. In the following Arguments from Analogy, introduce factors that increase and factors that decrease the probability that the conclusion is true:

1. Tar smeared on the exposed skin of mice caused an 80% increase in the incidence of skin cancer in the group. Therefore, tar smeared on the lining of the lungs of human beings will cause an increase in the incidence of lung cancer.
2. My last pair of Hike running shoes made my feet feel extra good. That's how I know that my new pair will give me great satisfaction.
3. You let my older sister stay out till midnight when she became 16. Now I am 16, so you should let me stay out till midnight.
4. Fathers should set the rules for their family in the same way that God set the rules for the universe. Wives should obey their husbands as nature obeys God's laws.
5. Chimps have learned to use sign language. Therefore, birds will probably be able to learn sign language.
6. If a person spends more than they make, they will face financial ruin. And if our country spends more than it receives in taxes, then it will face financial ruin.

C. In each of the following, identify the primary and secondary analogue, and discuss their similarities and dissimilarities.

1. Most men are like spoiled children. They must have cars and tools the way a child has toys and games.
2. The earth is like a lifeboat afloat on the sea. That is why we must conserve our resources.
3. I felt horrible when I had the flu so I know how you must feel.

D. For each of the following, underline the term that best completes the analogy:

1. Woman/man = day/? (week, hour year, night, darkness)
2. Bachelor/unmarried man = father/? (mother, child, male parent, uncle)

C. Causal Inference

Necessary and Sufficient Conditions

Some inductive arguments involve inferring that two events, C and E, have a **cause-effect** relationship. What we identify as the cause, C, of E must precede E and is influenced by the kinds of interests we have in E events. If we are interested in producing E events, then we look for **sufficient conditions**, CS, such that $CS \supset E$. If we are interested in preventing E events, then we look for **necessary conditions**, CN, such that $\sim CN \supset \sim E$.

Suppose we are interested in **sufficient conditions** for accidental housefires. There are many ways that housefires can be produced: cigarettes, cooking, heating, electric short-circuits, gas leaks, lightning, etc. In each case, a particular cause may probably be sufficient to produce a housefire. Thus, a lit cigarette that falls onto dry paper will probably produce a flame, but not necessarily. And the flame it produces may cause the house to catch fire, but not necessarily.

When we say that CS is sufficient to cause E, we really mean that CS makes E highly probable given the circumstances. Thus, if an electrical short-circuit burns the insulation from around the wires, it becomes more probable (but not necessary) that a fire will result. Likewise, if a house is struck by lightning or develops a gas leak, the probability of a housefire increases significantly. Each of these might probably be sufficient to produce a housefire under ordinary circumstances.

If we are interested in preventing E events, then we look for **necessary conditions**, CN, for E such that $\sim\text{CN} \supset \sim\text{E}$. Thus, lack of intention to start a fire is a necessary condition for an accidental fire. Likewise oxygen is a necessary condition for fires, because if there is no oxygen present then there will be no fires. But we cannot remove all oxygen from the atmosphere to prevent housefires. And even if we could we should not, since oxygen is necessary for our metabolic processes as well.

While we cannot eliminate the conditions necessary for all fires, we can reduce the probability that a housefire will occur by eliminating the conditions necessary for the major types of housefire. Thus, by eliminating the smoking of cigarettes in a house (No smoking allowed!), eliminating electrical short-circuits and gas leaks from the house (through regular inspection and maintenance), by eliminating the presence of combustionable materials in the house (No storage of gasoline allowed!), we reduce the probability of housefires. But we do not eliminate all possibility of housefires.

Mill's Methods¹

Mill's Methods of Agreement and Difference have been widely used in identifying necessary and sufficient conditions. In the **Method of Agreement**, we look at all cases in which an event of type E occurs, and we identify those conditions that are present with each of the occurrences of E. These conditions are possible sufficient causes of E: whenever events of type E have occurred, conditions of type CS have been present. Sometimes a factor, B, is co-present with CS when E is produced, but B is nonetheless not causally related to E. In such cases, we would have a correlation between B and E, but B would not be a cause of E. To illustrate, increased ice cream sales accompany

¹ Mill, John S. *A System of Logic, Ratiocinative and Inductive*. New York: Harper & Bros, 1858. Print.

increased deaths from swimming, but increased ice cream sales do not cause increases in swimming deaths.

Mill's **Method of Difference** is used to identify those conditions, CN, such that, when they are not present, an event of type E does not occur. The Method of Difference will identify all conditions that could be necessary for E. CN is a necessary condition for E means $\sim\text{CN} \supset \sim\text{E}$. When events of type CN are prevented, events of type E are prevented. Thus, the presence of oxygen is a necessary condition for fires because eliminating the presence of oxygen eliminates the possibility of fires. And eliminating rags and paint thinner reduces the probability of fire from spontaneous combustion.

Many detective stories analyze and solve crimes using the methods of agreement and difference. Suppose Jones has been somewhere nearby each time cars have been sprayed with yellow paint on Elm Street. And suppose further that such incidents have not taken place where Jones was not present. Then we have good reason to consider Jones to be necessary and sufficient for the spray painting crimes in question.

Finally, Mill's method of **Concomitant Variation** involves varying a condition C to see if it brings about variations in the occurrences of E. This notion of causation has been widely used in dealing with events where neither necessary nor sufficient conditions can be readily identified. Thus, smoking is considered a major cause of lung cancer, though smoking is neither a necessary nor a sufficient condition for lung cancer. Some people who smoke do not get lung cancer. And some who get lung cancer have never smoked. But populations with lower rates of smoking have lower rates of cancer, and populations with higher rates of smoking have higher rates of cancer. It is because variations in rates of smoking bring about concomitant variations in rates of lung cancer

that we are justified in saying that smoking causes cancer.² The causal relation between smoking and lung cancer allows us to predict that lung cancer rates will rise if smoking rates increase, and lung cancer rates will decrease if there is a decrease in the incidence of smoking. And we can know this even though we may not know exactly how smoking is causally connected to lung cancer in individual cases.

5.D.1. Exercises on Necessary and Sufficient conditions:

For each of the following, determine whether a necessary or a sufficient cause is implied:

1. x failed the test because he was too tired to concentrate.
2. y will graduate with honors because he had straight A's in every class.
3. x loves to dance because she's a teenager.
4. y will not go to college because he did not apply.
5. The fire was arson because it was intentionally started.
6. The fire was accidental because it originated from spontaneous combustion of oily rags.
7. x confessed because he was tortured.
8. y caught the flu because his roommate infected him.

² Likewise smoking is considered a major cause of housefires, even though smoking is neither necessary nor sufficient for the occurrence of housefires. Some people smoke in their homes but never have housefires. And some people have housefires who do not smoke. Nonetheless, the frequency of housefires is less among those who do not smoke and greater among those who do smoke. See Hill.

9. The flowers did not grow because they were not watered (did not get enough sunshine).
10. The snow is melting because it is getting warmer outside.
11. Saccharine causes tumors in lab rats.
12. The A rats have tumors and the B rats do not because A rats were fed saccharine and the B rats were not.
13. The assassination of MLK caused the black community to erupt in violence.
14. Slavery and Jim Crow are the major causes of black poverty.
15. Lack of competition is the major cause of higher prices.
16. Global warming is being caused by industrial development.
17. Sea levels are rising because of global warming.
18. Smoking causes cancer.
19. x has cancer because x was a heavy smoker all her life.
20. The water will not boil because it has antifreeze in it.
21. x is no longer lonely because she now has a close friend.
22. The window broke because it was hit by a stone.
23. X's tires went flat because y slashed them

24. The gun fired because x removed the safety lock and pulled the trigger.
25. Y was shot because x aimed the gun at Y and pulled the trigger.
26. The fire was extinguished because we poured water on it.
27. The fire was started because the children were playing with matches.
28. Eating undercooked chicken ill cause you to be sick.
29. The lights came on because I flipped the switch.
30. Poor kids show poor academic aptitudes because life is not academic for them (they must devote their time to surviving rather than to reading).
31. The sea level is rising because the icebergs are melting.
32. Crime increases when unemployment increases.
33. Homosexuality will increase because same-sex marriage has become acceptable.
34. Cloning is possible because of in vitro fertilization.
35. Allergies are increasing because of increases in the use of antibiotics.
36. Stainless steel is resistant to rust because the iron it is made from has been treated with alloys.

Causal Inference in Science and Medicine

A central feature of modern science is use of the **Experimental Method** to identify the cause C of an effect E . While our discussion has proceeded as if a causal relation is a two place predicate connecting two variables, C and E , experiments make it clear that causal relations are three-place predicates: “ C is the cause of E ” is short for “ C is the cause of E in conditions Z ”. In a controlled experiment, the control situation Z_1 and the experimental situation Z_2 are analogues, and CS is introduced into Z_2 but not into Z_1 . If E occurs in Z_2 but does not occur in Z_1 , then we have good reason to believe that, in situations like Z_1 and Z_2 , CS is sufficient to produce E . On the other hand, if CN is followed by E in Z_2 but E ceases to occur when CN is removed, then CN is necessary for E in Z situations.

Modern medicine begins with the Germ Theory of Disease, when microbes were first identified as necessary and sufficient causes of disease. It is based on the work of **Robert Koch**, who first identified the microbial agent that causes cholera. Koch’s method of identifying a cause is referred to as **Koch’s Postulates**: In order for an agent, C , to be identified as the cause of malady E , C had to be: a. extracted from a host Z_1 who is suffering from E ; b. cultivated in vitro; c. then re-introduced into a healthy host Z_2 . d. If the malady subsequently manifests in the new host Z_2 , this demonstrates that C is sufficient to cause E in hosts like Z . On the other hand, if a host Z is suffering from E , and removing C removes E , this shows that C is necessary for E in hosts like Z .³

³ Koch, Robert. *Investigations into the Etiology of Traumatic Infective Diseases*. The New Sydenham Society, 1880.

Sometimes it is not possible to carry out an experiment where an element, C, is deliberately introduced or withdrawn from a situation Z in order to see how E is affected. But if it is possible to identify naturally occurring situations which are similar except for the presence or absence of the suspected cause C, we can then observe how this affects the presence or absence of E. Such non-experimental observations are the basis of research in **epidemiology**.

Something like this occurred prior to Koch's discovery of the cholera bacillus. John Snow noted that cholera occurred at a much higher rate in an area that received sewage contaminated drinking water than in an area that received uncontaminated water. He conjectured that reducing the level of human sewage in drinking water would reduce the rate of cholera. And where human sewage was reduced, cholera rates diminished. But this was before Koch identified the cholera virus. Snow showed how sources and remedies for a malady may be identified even when the specific cause of the malady is unknown.

In scientific studies, patients often show improvement simply because they believe they have been treated with something that will help them. But in many cases it is their belief that they will get better from the treatment, rather than the specific treatment itself, that causes them to feel better. Likewise, people often feel worse if they believe someone else has done something to make them feel worse. It is the belief in the potency of a curse, rather than the potency of the curse itself, that makes them feel worse. This is called the **Placebo effect**.

A similar situation is produced when experimenters (often unintentionally) interact with their experimental subjects differently from how they interact with their

control subjects. And it is the difference in interactions rather than the difference in treatments that causes differences in outcomes between the experimental and the control group. This is called the **Experimenter Effect**. Double blind experiments are used to eliminate sources of bias generated by the expectations of both the experimental subject and the experimenter. In a **double-blind experiment**, neither the experimenter nor the experimental subject knows whether the subject is receiving a genuine treatment or a fake treatment.

Common Causal Fallacies

Post hoc, ergo propter hoc: If B follows A, then B was caused by A.

One of the basic rules of causation is that a cause must precede its effect. Thus, when two things occur together in sequence, we tend to believe that the earlier event is the cause of the subsequent event. This is why, when the magician taps his magic cane and a rabbit appears, we are inclined to believe that tapping the cane caused the rabbit to appear. However, the fact that two events occur in sequence does not mean that the earlier event is the cause of the later event. This expectation is the source of many fallacies in causal attribution.

Examples:

1. Every time we have won we have prayed before the game. That is how we know that prayer is the primary cause of our success.
2. A black cat crossed my path. That is probably why I had an accident later on.
3. I took xyz cold medicine and two days later my cold was gone. Therefore xyz cold medicine caused my recovery from the cold.

Correlation is not causation:

Just because two events vary together doesn't mean that one is the cause of the other.

Often, the variation in both the two events may be the effect of another factor altogether.

Examples:

1. As ice cream sales increase, drowning deaths increase. And as ice cream sales decrease, drowning deaths decrease. Therefore more ice cream eating is causing more drowning deaths.
2. Night is always followed by day. Therefore the passing of the night brings about the coming of a new day.

Confusing cause with effect

1. The crowing of the rooster causes the sun to rise. (Or does the rising of the sun cause the rooster to crow?)
2. Low IQ causes impoverishment. (Or does impoverishment cause low IQ?)
3. The child's misbehavior causes the parents to be short-tempered. (Or does the parents' short temper cause the child to misbehave?)

Fallacies of Variation

1. Rain is necessary for corn to grow. Therefore, the more it rains, the more the corn will grow.
2. A good education is necessary for a good job. Therefore, the more education you get, the better job you will get.

Confirmation Bias

If C1, C2, and C3 are possible sufficient causes of E, focusing initial attention on C1 increases the likelihood that C1 will be accepted as the cause of E, even if additional evidence makes C2 or C3 the more likely cause. Confirmation bias makes it likely that people will look for evidence that confirms their assumptions rather than for evidence

that challenges those assumptions. But preconceptions that are maintained in the face of contrary evidence are fixed and likely to mislead.

Causation in the Social Sciences

Currently, a famous set of experiments in the social sciences has been used to demonstrate the existence what is called “**stereotype threat**”. Prof. Claude Steele has provided evidence to show that fear of confirming a demeaning stereotype negatively affects performance. There is much anecdotal evidence (from coaches, parents, counselors) that what a person believes about their capabilities affects their performance. Steele provides experimental evidence, generated under controlled conditions, showing how preexisting beliefs can produce performances that reinforce those beliefs. Steele’s innovation is in creating experimental, and not just anecdotal, evidence for the existence of effects produced by preexisting stereotypes. This evidence is meant to be replicable by others under similar conditions.

Steele proceeds in classic scientific manner. A group of subjects, *Z*, is chosen and (randomly) divided into two groups, *Z1* and *Z2*. *C* is introduced into *Z2*, the experimental group and *C* is not introduced into *Z1*, the control group. If *E* is produced in *Z2* but not in *Z1*, then we are justified in considering *C* to be the cause of *E* in groups like *Z1* and *Z2*. Using this model, Steele was able to demonstrate the effect of stereotype threat on many different groups.

Thus, suppose two groups of black students, *B1* and *B2*, are chosen who are alike in all relevant features, and *B1*’s are told they will take an IQ test while *B2*s are told that it is a vocabulary test under development. Steele showed that *B2*’s consistently performed worse than *B1*s, and he attributed this to *B2*’s apprehension that they would

confirm the stereotype of black people having low IQs. Likewise, two groups of female students, F1 and F2, were chosen who were alike in all relevant features, and F2s were told they would take a test of their potential for athletics and F1s were told that it was a test of their vocabularies. Again F2s consistently performed worse than F1s, because of the threat of confirming the stereotype that women have low athletic ability.

In another recent study (4/24/2104) student athletes were divided into two groups, A1s and A2s. Before the test, students in A2 were asked about their sports activities on campus while students in group A1 were asked about the dining services. Students in group A2 who were reminded of their status as athletes consistently performed worse on the test (confirming the “dumb-jock” stereotype) than similar students who were not reminded of their status as athletes.

The effect of stereotype threat on performance has become a model of how unexamined preconceptions can contribute to behavior that supports those very preconceptions. Being rational requires resisting the tendency to (i) favor evidence that confirms a preexisting assumption and (ii) ignore evidence that tends to disconfirm that assumption.

5.D.2. Exercises needed on (a) experiments in the natural and social sciences; (b) common causal fallacies.

CHAPTER 7

INFORMAL FALLACIES

A deductive fallacy is committed whenever it is suggested that the truth of the conclusion of an argument necessarily follows from the truth of the premises given, when in fact that conclusion does not necessarily follow from those premises. An inductive fallacy is committed whenever it is suggested that the truth of the conclusion of an argument is made more probable by its relationship with the premises of the argument, when in fact it is not. We will cover two kinds of fallacies: formal fallacies and informal fallacies. An argument commits a formal fallacy if it has an invalid argument form. An argument commits an informal fallacy when it has a valid argument form but derives from unacceptable premises.

A. Fallacies with Invalid Argument Forms

Consider the following arguments:

- (1) All Europeans are racist because most Europeans believe that Africans are inferior to Europeans and all people who believe that Africans are inferior to Europeans are racist.
- (2) Since no dogs are cats and no cats are rats, it follows that no dogs are rats.
- (3) If today is Thursday, then I'm a monkey's uncle. But, today is not Thursday. Therefore, I'm not a monkey's uncle.
- (4) Some rich people are not elitist because some elitists are not rich.

These arguments have the following argument forms:

- (1) Some X are Y
 All Y are Z
 All X are Z
- (2) No X are Y
 No Y are Z
 No X are Z
- (3) If P then Q
 not-P
 not-Q
- (4) Some E are not R
 Some R are not E

Each of these argument forms is deductively invalid, and any actual argument with such a form would be fallacious. There are many other forms that an argument might have that would make it invalid (and thereby fallacious), and it was the purpose of Chapters 1, 2, 3, and 4 to provide us with procedures for describing and testing the formal validity of argument forms.

One common kind of formal fallacy derives from the use of ambiguous terms. In Chapter 3, we explored how such fallacies derived from a faulty middle term in a syllogism. Thus, “Every lion is ferocious and Haile Sellassie was the Lion of Judah so Haile Sellassie must have been ferocious” has the syllogistic form:

- All L are F (major premise)
All HS are L' (minor premise)
All HS are F (conclusion)

The fallacy involves treating L as if it were the same as L', thus suggesting that the argument has the valid form:

All Y are Z

All X are Y

All X are Z

Whenever an ambiguous word or phrase or sentence is used in more than one sense to draw a particular conclusion, we have a fallacy resulting from ambiguity. This pattern is exhibited in the fallacies of Equivocation, Amphiboly, and Accent.

I. The Fallacy of Equivocation

A term (i.e., word or phrase) is equivocal if it has different meanings in different contexts. The fallacy of equivocation arises when alternate meanings of the term are used to gain acceptance of the premises and draw the conclusion offered.

Examples:

(1) The rich farmer told the pretty young woman that he would give her everything he had in his banks if she would marry him. She agreed, and after the wedding she did everything to please. Finally, she wanted to know how much was hers, as had been promised. The farmer took her to the river that ran through the middle of his great farm and told her, "Everything you see in those banks is yours. I suppose it's about 20,000 gallons of water a day, all yours."

(2) No government that is divided can stand. But the U.S. Government is divided into legislative, judicial, and executive branches. So, the U. S. Government cannot stand.

(3) Every kid needs to learn to read and write. Baby goats are kids. Therefore, baby goats need to learn to read and write.

The first example involves an equivocation on the word “bank” and its meaning as: (a) a financial institution for storing and preserving money and valuables, and (b) as the sides of a stream, river, lake, sea or other substantial body of water. Example (2) involves equivocation on the phrase “government that is divided.” The phrase is used initially to suggest the meaning “Government that is divided between warring factions” but afterwards, it is used to mean “government that is divided into branches with different functions.” The final example involves an equivocation on the term “kid,” which is used initially to mean “a young human being”, but subsequently is used to mean "a young goat.”

6. A. 1. Exercise:

Explain how the terms pitcher, bat, bank, spoke, fish, dig, square, bad, could be ambiguous. Try to formulate arguments in which these terms are used ambiguously.

A common way of describing groups is in terms of group averages. But different concepts of averages can be used equivocally to lead to a particular conclusion that in fact does not follow. Thus, suppose firm A has 10 employees where 9 make \$10,000 p/y and the president makes \$110,000 p/y. The total salary is \$2,00,000 for the 10 employees, gives an average salary of \$20,000 per employee. The president of a firm can truthfully say that the average salary is \$20,000 p/y. The average being used by the president is the mean, which is the total amount paid in salaries divided by the total number of workers. But the mean tells us nothing about how salaries are distributed in firm A. On the other hand, the union will stress that the average salary is 1/11 the salary of the president.

Suppose that firm B has 10 employees, each making \$20,000 p/y. B also has a mean salary of \$20,00 p/y. but the mean in firm B is much more indicative of what the

‘average’ worker actually earns. The mean, mode and median are different ways of talking about group averages. The mean salary is the total paid in salaries divided by the number of individuals paid. The modal salary is the salary that most employees make. The modal salary for A is \$10,000 p/y. The modal salary for firm B is \$20,000, twice the modal salary in A. Yet each has the same average in terms of the mean.

Another way of characterizing a group is in terms of percentages.

Equivocation in using percentages occurs when a percentage calculated on one base is used as if it applied equally to a different base. Consider the following examples:

Claim:

A survey showed that people who use Pepodent have 20% fewer cavities. Therefore, if you use Pepodent you will probably have 20% fewer cavities than if you didn’t use Pepodent.

Analysis:

It may be true that Pepodent users have 20% fewer cavities on average than non-Pepodent users. But this does not imply that using Pepodent will cause each user to have 20% fewer cavities.

Claim:

People who go to college make 50% more income. Therefore, if you go to college you’ll make 50% more income than if you didn’t go to college.

Analysis:

The class of people who go to college may make 50% more income. But going to college may not lead each graduate to make 50% more than if they had not gone to college.

Claim:

Suppose a merchant spends \$9 on merchandise each day that she then sells for \$10. Her total sales for the year are \$3650. With a profit of \$365, this gives her a return (on total sales) of 10%. But with an initial investment of \$9 and a final profit of \$365, the percentage return (on initial investment) is 500%. The company made 10% return on total sales but a 500% return on initial investment.

Analysis:

The above fallacies involve calculating a percentage on one base, then then applying it to a different base.

6. A. 2. Exercise: Analyze each of the following claims:

Claim:

20% off of list price. A week later, take an additional 30% off. Therefore, customers are receiving a 50% discount. (But in fact, they only have 44% discount.)

Claim:

10% of As are Bs. 10% of Bs are Cs. Therefore, 10% of As are Cs.

Claim:

A makes \$10,000 a year and her salary is reduced by 20% to \$8,000. A year later her salary is increased by 20%. Therefore, A makes the same as she originally did.

II. Fallacy of Amphiboly

A sentence that has two distinct meanings because of as the way it is constructed is called an amphibolous sentence. The fallacy of amphiboly occurs when one meaning of an amphibolous sentence is used to gain acceptance of a premise and an alternative meaning is applied to the conclusion drawn.

Examples:

- (1) General Hush said the terrorists must be stopped before rising from his desk. Any person who sincerely believes that people are waiting to arise from inside his desk is mentally ill. Therefore, General Hush is mentally ill.
- (2) Mr. A. Don't you agree that all men are not sexist?
Ms. B. Yes.
Mr. A Then, you must be mistaken in describing me as sexist, despite my natural superiority to women. For what is true of all men must certainly be true of me.
- (3) The editor said she would lose no time in reading my manuscript. Therefore, she will probably have read it before this week is over.

In the first example, the statement “Hush said the terrorists must be stopped before rising from his desk” is ambiguous between: (a) a situation in which Hush said “The terrorists must be stopped” before he arose from his desk; and (b) a situation in which Hush said that the terrorists must be stopped before they arose from his desk. Without a doubt, (b) depicts a rather bizarre state of affairs while (a) is perfectly ordinary. In the second example, the proposition “All men are not sexist” is ambiguous between “Some men are not sexist” and “No men are sexist.” The conclusion of the argument makes use of the second meaning though it is probably the first meaning that leads Ms. B to accept the ambiguous statement as a premise. In the third example, the locution “X will lose no time in doing Y” is ambiguous between “X will not do Y” and “X will begin doing Y immediately.”

III. Fallacy of Accent

When interpretations of a statement can be changed by placing emphasis on different syllables or terms in the statement, the statement is accent-ambiguous. The fallacy of accent is committed when one interpretation is used to gain acceptance of the premise but a different interpretation is used in drawing the conclusion.

In the following examples, the statement, “I believe that all men are created equal” is ambiguous in at least five different ways, depending on what word is accented in using the statement as a premise.

(1) I believe that all men are created equal. However, that does not require that you believe that all men are created equal. Therefore, you are not obligated to practice non-discrimination as I do.

(2) I believe that all men are created equal. However, what I believe need not be the case. Therefore, it may be that in fact all men are not equal.

(3) I believe that all men are created equal. But this certainly does not extend to women. Therefore, I oppose the Equal Rights Amendment to the constitution. The Founding Fathers didn't believe women were equal to men either.

(4) I believe that all men are created equal. But once their creation is finished, some men work harder than others. The social equalities we see between men are no more created by God than the mighty skyscrapers we see as we drive through our nation's capital. But just because God didn't create skyscrapers during the six days he took to create the solar system, that doesn't mean that we should therefore destroy them. And neither should we destroy social inequalities.

(5) I believe that all men are created equal. That means that no person has a right to certain kinds of opportunity that other people do not have an equal right to. Therefore, I believe that if a man can be operated on so that he is implanted with a functional womb, then he should be allowed the opportunity to give birth to a baby.

B. Category Fallacies

This group of fallacies - the fallacy of division and the fallacy of composition- involves equivocation between: (a) using a term to refer to a class as a whole and (b) using the term to refer to a member of that class.

The **fallacy of division** takes what is true of the whole to be true of all the parts. The fallacy of division arises when a concept is used as a collective unit in the premise, then a conclusion (based on the truth of that premise) is drawn in which the same concept is applied to an individual unit of the collection.

(1) America is the richest country in the world.
Since you are an American, you must be rich.

(2) Smith has a better basketball team than Wellesley. Mary is a player on Smith's team. Phyllis is a player on Wellesley's team. Therefore, Mary is a better basketball player than Phyllis.

The **fallacy of composition** derives from taking what is true of a part to be true of the whole. This is the reverse of the fallacy of division. Here a claim is made about the

individual elements of the subject term in the premises, yet a conclusion is drawn in which the claim is applied, not to the individuals, but to the collection as a whole.

- (1) Each individual on the team is over 6 feet tall.
Therefore, the team is over 6 feet tall.
(comment: teams do not have height.)
- (2) Each apple in the basket weighs less than a pound.
Therefore, the basket of apples weighs less than a pound.
- (3) Each of us acting individually can do little to make institutional changes.
Therefore, there is very little we can do together to make institutional changes.
- (4) All material things are made of atoms
All atoms are invisible to the naked eye.
All material things are invisible to the naked eye.

6. B. 1. Exercises: Name the fallacy involved in each of the following arguments.

1. You said you'd pay \$500.00 for each pound of weed I brought you. Well, I just finished mowing every lawn in the neighborhood and I have 100 pounds of weeds in these green bags. Therefore, you owe me \$50,000.
2. Under normal circumstances water placed over a fire in a pan will boil. This fire is in a pan. Therefore, when I put this water over it, the water should boil.
3. Students at Amherst College are only allowed to take five courses per semester. Amherst provides the staff to teach the courses. Therefore, Amherst provides staff to teach five courses per semester.
4. Each member of the Smith basketball team is a high scorer. Therefore, the Smith basketball team will make a lot of high scores this season.
5. Since each soldier in the regiment has been well trained, it follows that the regiment must be a superb fighting unit.
6. Since you said that the food was "sick," we may conclude that you would not recommend that restaurant as having delicious food.

7. The average American family has two and a half children. You are an average American family, therefore, you have two-and-a-half children.
8. The jury was unable to come to a verdict as to whether the defendant was guilty. Therefore each of the jurors was unable to make up his or her mind.
9. Rights within the State should always be balanced by responsibilities to the State. Therefore, those with the most civil rights ought to shoulder most of the responsibilities of government.
10. Rights within the State should always be balanced by responsibilities to the State. Therefore, those who make the least contribution to the State should have the least civil rights.
11. John said that he would give Tom and Mary \$5,000.00. John always tells the truth. Therefore John will give Tom \$5,000.00.
12. Whooping cranes are becoming extinct. That bird is a whooping crane. Therefore, that bird is becoming extinct.
13. A brick is very small. Therefore, a building made of brick must be very small.
14. Flour tastes horrible. And since it is the main ingredient in bread, bread must taste horrible.
15. Much religious teaching is contained in the Bible. The Bible is a word of five letters. Therefore, much religious teaching is contained in a word of five letters.
16. The Consumer Report says: "We cannot recommend this car too highly." Therefore, I should not buy that car.
17. The killing of the hunters is regrettable, my neighbor said. Therefore, my neighbor must be against hunting.
18. College graduates make on the whole more money than non-college graduates. Thus, since you are a college graduate and I am not, you must make more money than me.
19. A feather is very light. Therefore, a mountain of feathers is very light.
20. Mr. Senator, individual liberty is not being threatened or abused by the CIA because it authorizes only twenty categories of domestic and international espionage. This is a smaller number than any other country in the world. (The suggestion is that there were only twenty cases of domestic and international espionage carried out by the CIA).

21. Since I lifted each piece of wood that went into making this table, I must be able to lift the table.
22. The boss interviewing an young attractive secretary told her she could expect frequent advances. Therefore, she readily accepted the job.
23. Both hydrogen (H) and oxygen (O) are highly flammable. Therefore, H₂O must be highly flammable.
24. The house that you live in is large so it must have large closets.
25. I'm not worried that the six Beasley boys are coming to fight me. I've whipped each of them, so I know I'll be able to whip them again.

C. Fallacies With Valid Argument Forms

Formal fallacies are arguments that are defective because they have invalid argument forms. But while all invalid arguments are fallacious, it is not the case that all fallacious arguments are invalid. Indeed, many fallacious arguments have valid argument forms. For instance, the argument “All dogs are from outer space because all dogs are cats and all cats are from outer space” is fallacious, even though it has a valid argument form. It is fallacious because its premises are unacceptable and therefore do not lead us to accept the conclusion as true. Whenever a conclusion is asserted to have a certain truth-value on the basis of premises that are unacceptable, the argument is unsound and therefore fallacious. Many informal fallacies are a species of unsound arguments.

Generally, informal fallacies involve arguments that have faulty premises. Typically, the premises of such arguments are not stated explicitly (enthymemes), and the listener is led to accept them without careful examination. In what follows, we will introduce some of the most common forms of informal fallacies.

I. Appeal to the Person (Ad Hominem)

The fallacy of ad hominem is committed when the conclusion of an argument is rejected, not because of objections to the premises or steps connecting the premises to the

conclusion, but because of objections to the character and/or circumstances of the individual presenting the argument. This is illustrated in the following examples:

- 1a. Mr. A: Ladies and gentlemen, I would like to argue that a law requiring the mandatory sentencing of individuals convicted of drug use should not be passed. For such a law would require so much money to implement that we would have to increase taxes and cut back on the school budget, benefits for the elderly, and police and fire protection.
- 1b. Mr. B: Ladies and gentlemen, you should not accept Mr. A's argument against the mandatory sentencing of criminals convicted of drug use. For Mr. A is a former drug user himself, and is currently free on probation. If we had a mandatory sentencing law, Mr. A would not be here before you tonight.
- 2a. Mr. C: Everyone should make a sincere effort to become a true Christian because that is the only way we are going to solve the world's problems.
- 2b. Mr. D: I don't agree with Mr. C because I don't trust anything he says. I've known Mr. C all my life and I know for a fact that he is not a true Christian. He's just a lying hypocrite.

Of course, there is nothing wrong in questioning the reliability or credibility of a person. This is often done by lawyers in courtroom cases. To do so is not to commit the ad hominem fallacy, for the purpose of the questioning is to provide grounds for doubting the truthfulness of the witness. Thus, the following situations must be carefully distinguished:

- (3a) Ladies and Gentlemen of the Jury, you should not accept the arguments of the attorney for the defense, because he is a known liar.
- (3b) Ladies and Gentlemen of the Jury, you should not accept the testimony of this witness because the witness is a known liar.

The statements in (4b) speak to whether certain statements alleged to be true by the witness are in fact true. If a person is known to misrepresent truth for personal gain, psychological release, or whatever reason, then the probability increases that under current circumstances he may be misrepresenting the facts. And if the truth-value of the premises is indeterminate, then the truth-value of the conclusion of that argument is also indeterminate. On the other hand, if there is no question as to the authenticity of all the evidence presented, then it is only to the validity of the argument into which that evidence is incorporated that criticism can be directed. In this case, one must show that the facts do not fit together in one's opponent's argument. It is no good to attack the character of the opposing attorney, as in (4a). The opposing attorney may be scrupulous in presenting witnesses that tell the truth and a genius at constructing clever arguments, yet be a scoundrel in her personal life.

4a. If A has a bad character then A's argument should be rejected.

A has a bad character.

A's argument should be rejected

4b. If A has a bad character then A's argument should be suspect.

A has a bad character.

A's argument should be suspect.

4a is an invalid argument, because an argument cannot be discredited by attacking its maker. An argument can only be challenged on two fronts: the truth-value of its premises and the validity of its form. If the truth of the assumptions proposed is guaranteed by someone whose truthfulness is suspect, then that person's guarantee is suspect. Thus, those assumptions may be considered insufficient to establish the truth of the conclusion in question. The other basis for rejecting the argument is whether the argument form is valid. But the validity of an argument form is independent of the trustworthiness of the maker of the argument, because the validity of an argument form is independent of the actual truth or falsity of the statements that make it up.

The ad hominem fallacy is also committed in what is called the “You also!” (Tu quoque) argument. Here, the accused defends herself by charging the accuser of having committed the same act she is being prosecuted for. The erroneous premise of such arguments is that the accused should not be held responsible for doing x if others have done x without being held equally responsible.

(5) Members of the American military should not be prosecuted for killing civilians during the war in Iraq. Al Qaeda has practiced the killing of civilians as part of its holy war tactics. Yet, Al Qaeda sympathizers have not condemned Al Qaeda. So, members of the American military should not be condemned and punished when others are doing the same thing.

(6) Senator X has accused me of being financed by Big Business. Well, in reply let me point out that much of the money for Senator X’s campaign has come from Big Business.

(7) American presidents defended legalized segregation by pointing out that many other countries violated the rights of certain groups of their own citizens.

Observe that, in the tu quoque (you also!) argument, A argues that B’s accusation about A should be rejected because B is guilty of a similar offense. Thus, attention is redirected from the charge to the maker of the charge. But even if the counter-accusation is true, this does not imply that the original accusation was false. To answer an allegation of misconduct by citing the accuser's similar misconduct is only a means of confusing the issue. What is needed in order to meet an accusation is not a counter accusation, but an argument showing that the accusation being made is unwarranted.

II. Appeal to Authority (Ad Verecundiam)

In this fallacy, reverence for a particular authority is used to gain acceptance of a particular conclusion, without due consideration of the reasons advanced by the authority in support of that conclusion. The corrective to the fallacy of appealing to authority is to

examine the argument used by the authority to come to the conclusion in question, and to base our acceptance or rejection of the conclusion on that argument, not merely on our respect for the maker of the argument. Authorities appealed to may be as varied as the Bible, one's parents, respected teachers, newspapers, a popular actor or actress, a sports celebrity and so on. Consider the following examples:

(1) The Pope has declared that from the moment of conception, the fetus is a human being and hence, that abortion is murder. Since the Pope said it, abortion must therefore be murder.

(2) Dr. John Kalk, the noted physician and Nobel Prize winner, says that up until the third month, the fetus has more in common with a monkey than with a human being, and therefore, that abortion prior, to the third month is not murder. Since Dr. Kalk is a noted scientist, if he says that abortion is not murder, then it must not be murder.

(3) The president said that it was necessary to relinquish the Panama Canal in order to maintain stability in Central America. Since he's the president, he ought to know what's best. So we may conclude that we should have relinquished the Panama Canal.

Each of these examples has the form:

If authority A says that P is true, then P is true.

Authority A says that P is true.

P is true.

While this is a valid argument, it is not necessarily a sound one. The premise, "If authority A says that P is true, then P is true" is not always true. Any authority may be wrong some times. Authorities are called upon when specialized knowledge is required in order to determine if P is true. If A has such specialized knowledge, then A's opinion concerning the truth or falsity of P is more likely to be correct than the opinion of persons not in possession of such knowledge. However, there are often cases where two or more individuals with equivalent degrees of specialized knowledge nonetheless disagree as to the truth or falsity of P. When experts disagree, then judges and juries must consider the evidence, reasons, and arguments of representative experts.

Some further examples of appeal to authority are:

- (4) Hyrd station wagons are superior to other brands of station wagons because Knut Ruckney, football coach of Notre Dame, drives a Hyard and says that Hyrd makes the best station wagon in the world.
- (5) Doxema is the best shave cream on the market because Eli Kanning, the well-known quarterback, uses it.

These examples illustrate how the proposition “If authority A says that P is true, then P is true” is not always true. The fact that Knut Ruckney might be an authority on football does not mean that he is an authority on automobiles. An authority in one field is not necessarily an authority in another. Yet, advertising suggests that an authority in one field is equally an authority in another when individuals who excel in one area (sports, music, science, etc.) are asked to testify concerning issues in an entirely different area.

III. Appeal to Ignorance (Ad Ignorantiam)

This fallacy arises when an argument is accepted (or rejected), not as a result of an examination of the relationship between its premises and conclusion, but rather as a result of ignorance of key concepts used in the argument. Because of the need for specialized knowledge, this fallacy is often combined with an appeal to authority.

- (1) Amplifier A has 25 KMI per channel. Amplifier B has 40 KMT per channel. They cost the same. Therefore, Amplifier B is the best buy.
(more examples needed)

IV. Appeal to the Mob (Ad Populum)

This fallacy is committed when an audience is induced to accept a certain conclusion on the basis of appeal to interests, preferences, and values common to the speaker and the audience. Such arguments have the following general form:

If we have the same values and interests, then P is true.

We have the same values and interests.

P is true.

Speaker: "Do you want freedom of speech?"

Crowd: "Yes!"

Speaker: "Do you want to be ruled by a dictatorship?"

Crowd: "No!"

Speaker: "Do you want a decent living?"

Crowd: "Yes!"

Speaker: "Then we want the same things. So vote for me and let's make the world safe for democracy."

Rufus Dufus was caught at the scene of the crime. A good, upstanding woman just like our wives, sisters and mothers, said she was assaulted. Is this what we want for our womenfolk? Is this what we are going to allow our daughters to face when they grew up. No! We must have law and order and safety for our loved ones. We have to let vicious criminals know that we will not stand for such atrocities. So let's string Rufus up now and set an example that such will not be tolerated in this town.

V. Appeal to Pity (Ad Misericordiam)

Compassion is an important human emotion. It is good and necessary that we should feel concern for the plight of others. But this does not mean that our actions must always be guided by our feelings. Unfortunately, there is often sincere confusion on this point. To illustrate, suppose A is approached by a handicapped beggar and A gives him money. She might explain her action by saying that she was moved by pity to help the beggar. The framework for her action would then be given the following argument:

If I feel pity for x, then I should help x.

I feel pity for x.

I should help x.

This is certainly a valid argument, but not always a sound one. It is possible that she might be moved to feel pity by an imposter. Though she felt pity, it is unlikely that she would help the imposter purely because of what she felt. A more suitable justification for her act of compassion would be:

If I believe x needs help, then I should help x.

I believe x needs help.

I should help x.

If what we believe provides the framework for our actions, then whether we feel pity or not becomes irrelevant to whether we try to provide aid. We may feel pity but believe that help is not needed or we may believe help is needed without feeling pity. Logic encourages us to guide our actions, not merely by our feelings, but by our assessment of the situation and the moral principles we are committed to. The following examples illustrate situations in which a fallacious appeal to pity is made the basis for accepting a particular conclusion.

(1a) Student:

“Professor, I lost my job last week, my mother became seriously ill, and now it seems that I may not pass your course. If I fail, I don't know if I will be able to stand the strain of all my bad luck. If you have any feelings at all you should give me a passing grade in this course.”

(1b) Professor:

“I sympathize with your bad luck, Ms. Student, but I am prohibited from allowing my feelings about you to influence the grade that I give for this course.”

(2a) Defense:

“Ladies and gentlemen of the jury, my client was born in poverty. His father was killed in Iraq and his mother was afflicted with multiple sclerosis when he was three years old. He tried hard to stay in school but was forced to work in order to bring food

home to his sick mother. I ask you, ladies and gentlemen of the jury, not to impose yet another burden on my client. I ask you to find him not guilty of the crime he is accused of.”

(2b) Prosecutor:

“Ladies and gentlemen of the jury, I share with the defense a concern for the misfortunes that the accused has suffered. But that has nothing to do with the actual fact of whether or not he committed the crime he is accused of. All the evidence points to the conclusion that he did commit that crime. Therefore, we are bound by law to find the defendant guilty.”

In example (1b) the professor may believe that the student deserves aid because of her unfortunate situation, but he is expressly forbidden by the code of the university from offering a passing grade as aid. Likewise, the members of the jury in example (2b) may feel compassion for the defendant, but they too are expressly forbidden by the codes of law from acquitting the defendant purely on the basis of their feeling of compassion and belief that he deserves aid. These examples show how the kind of aid we are allowed to give is often limited by the codes, principles, and rules governing our social roles. The professor is prohibited from giving a grade on any criteria except that of classroom performance. A jury is prohibited from acquitting a defendant on any grounds except insufficient evidence. The fact that a store clerk feels or believes that the destitute person outside the store needs help is not a legitimate justification for giving that person merchandise that has not been paid for.

VI. Appeal to Force (Ad Baculum)

When it is suggested to a person that dire consequences will befall her if she does not accept (or reject) a given conclusion, we have an appeal to force. In such cases, the conclusion is accepted (or rejected) on the basis of fear induced by a suggested threat.

If you do not wish to suffer harm, then you will do x.

You do not wish to suffer harm.

You will do x.

While this is a valid argument, there are nonetheless many situations in which one is expressly forbidden from acting on the basis of the premise “If you do not wish to suffer harm, then you will do x.”

(1a) Student:

“Professor, I beat a man up real bad who didn’t give me what I wanted. Therefore, you’d better give me a passing grade in this course.”

(1b) Professor:

“I certainly do not want to be beaten up. But nonetheless I am expressly forbidden from awarding you a passing grade in this course for such a reason.”

(2) Mr. B:

“Jones, you’ve been an employee of mine for a long time and I know you want to keep your job. Therefore, I hope you’ll find time to help my friend, Senator Tydings, in his re-election campaign.”

(3) Mafia Boss:

“Ms. Smith, you’ve had this store for many years without any serious accidents. I know you want to keep it that way. But a number of store owners who don’t carry my insurance policy have recently experienced horrible fires that have closed down their businesses. I hope you’ll buy my insurance policy.”

VII. Appeal to Pride

In the appeal to pride, the attempt is made to influence a person's acceptance or rejection of a certain conclusion by making that conclusion appear as a reflection of the person's character. The person's desire to improve and enhance his or her self-image becomes the primary factor determining the acceptance or rejection of the conclusion in question.

Arguments that appeal to pride generally have the following form:

If you want to be admired then you will do X.

You want to be admired.

You will do X.

Examples:

(1) Student:

“Professor, I know you wouldn't want people to think that I failed your course because of the inadequacy of your teaching. Therefore, you should give me at least a passing grade in this course.”

(2) Salesman:

“Mr. Stowson, you look to be a man of quality. Therefore, I know you will only want the best that we have to offer.”

(3) Friend:

“Socrates, if you do not escape with us tonight, people will think you do no value your life. Therefore, you must try to escape with us.”

6.C.1. Exercises:

Name the fallacy involved in each of the following arguments:

1. Jones' argument should not be accepted because Jones is a drug addict and an alcoholic.
2. My parents always voted for the Democratic party and what was good enough for my parents is good enough for me.
3. The Bible says that the Children of Israel are the chosen people. Therefore, Israel is the land of the chosen people.
4. We all have families. We have churches and schools that we attend together. And we have our right as citizens to choose our government representatives. For me, that choice will be Bill Brent, and I know you'll make him your choice as well.

5. Car A has a 470 cubic inch motor while car B has a 370 cubic inch motor. You should choose car A because it gives you more engine volume.
6. Everybody is smoking weed, so it must be good for you.
7. Native American people have suffered ever since Europeans came to this country. That is why Native American people should be given more welfare benefits.
8. The Venezuelan government should not nationalize oil production in Venezuela because the United States will consider that an economic threat and might move to destabilize the Venezuelan government.
9. Ladies and gentlemen of the jury, this young man comes from a family of convicted criminals. His mother, father, and each of seven sisters and brothers have been convicted of charges from murder to stock market fraud. Therefore, his attorney's arguments in his behalf should be ignored, and the evidence accepted as proving him guilty of the charges being brought against him.
10. The doctor says that I need an operation. Well, I suppose since he's the doctor, he ought to know. So I guess I'll have to have it.
11. Seventy percent of the people of Falls Point, Virginia own Yototas. Isn't that reason enough for you to make a Yotota your next car?
12. IQ test scores have shown a positive correlation of 0.25 with academic performance and professional success. That is why they should be continued in all our schools.
13. Since you have a wife and four children and you want to keep your job, I believe you should contribute to mayor Rabby's campaign fund.
14. Jim broke both his legs during the war. He hasn't spoken to any of his friends since he's been out of the hospital. But when he saw you, his whole personality changed. That's why you should go out with him tonight.

15. Dr. Joan Saudelby, noted psychiatrist, recommends extramarital sex for release of tension. Therefore, married couples would be more relaxed if they engaged in more extramarital affairs.
16. One thousand, one hundred, and twenty-six cross tabulations of significant data has shown that Michton shock absorbers out-perform all its major competitors. So you should buy Michton.
17. Most people in my hometown don't agree with same-sex marriage. That's why I'm against it.
18. Dr. Philip Whatley, noted ophthalmologist, considers La Plume de la France to be the best restaurant in town. Therefore, it must serve excellent food and give excellent service, for Dr. Whatley is famous around the world.
19. Sheriff, you should not charge me with jaywalking because I've seen you do it hundreds of times.
20. Yes, I knew I've been late to work everyday this month. But how could you fire me? I have a child and I have to get up and dress the child and get her to a babysitter. If I don't have a job, how can I take care of my baby? You just can't fire me.
21. Ms. Priscilla, I know you need to pass this course in order to graduate, but your work and attendance has been marginal. Therefore, I suggest that you meet me this evening so that we can pursue this matter further.
22. I don't feel that I'm guilty of adultery because my wife is doing the same thing that I am doing.
23. What were the most memorable events of your life? When you made that great play that saved the game? When you graduated from high school? When you got married? When you had your first baby? To these you will add your first experience of Dogen Mavid after-dinner wine. So try some today.

24. Independent laboratory tests of ninety-seven random samples of Create natural deodorant did not vary by more than 0.3% from natural body odor. That's why you should switch to Create deodorant.

25. Archie Ali, the new heavyweight boxing champ of the world says that if you want the heavyweight champ of car waxes, get DuraBond Carwax.

D. **Miscellaneous Fallacies**

a. Fallacy of Contradictory Precepts

The fallacy of contradictory precepts occurs when incompatible premises are used to draw a certain conclusion, The problem is that from incompatible premises, any conclusion whatsoever can be validly deduced.

“Give to the church”, cried the minister. “It is easier for a camel to pass through the eye of a needle than for a rich man to enter into the kingdom of heaven. So, if you are able to give, you had better give. And remember too, whatever riches you give to God, He will give back to you tenfold. So give all you have.”¹

(More Examples Needed)

b. Arguing in a Circle (Vicious Circle)

An argument is circular if the conclusion of the argument occurs as one of the premises of the argument.

- (1) Heroin causes addiction because it has addictive powers.
- (2) Capitalism causes misery because its basic tendency is to make people suffer.

¹ The first premise implies that a person should give to the church in order to avoid being rich, while the second premise implies that a person should give to the church in order to receive even greater riches.

c. Complex Questions

A question is “complex” when any attempt to answer it implies the acceptance of statements that are themselves in question.

Examples:

Lawyer to Accused: “Tell the court, Sir, how it felt to have so much money after the holdup?”

Why is it that wealthy people are more intelligent than poor people?

d. Idealization of the Future

Here, one is influenced to accept a conclusion by appeal to some idealized future outcome that one is prone to hope for.

(1) “John, you ought to go to college because when you graduate, you can get a good job and never have any more financial problems.”

(2) “Bill, you don't need to go to school because everything is crumbling and we'll all be given enough to eat by the government.”

e. Idealization of the Past

Here, one is influenced to accept a framework for acting by appeal to some idealized past state of affairs that one is prone to accept.

(1) Europeans should be eliminated from America because before they came, Native Americans lived in harmony with nature.

(2) The Black man should be eliminated from America because, before slavery, all Europeans were industrious and hard working.

f. Fallacy of the Special Case (Hasty Statistical generalization)

To argue that whatever is true of one special case must be true of all cases of that general kind is to commit the fallacy of the special case. What is true of one individual need not be true of all individuals of a like kind. Just because one presidential administration was deceitful, we should not conclude that all presidential administrations are and will be deceitful.

Examples:

Bill Clinton was unfaithful while in office. We need to be wary of these white southerners.

Often, extreme cases are presented as the standard by which some present issue or activity is to be compared:

“I’m not a genius. Therefore, you can’t expect me to always think before I act.”

SUMMARY

The validity of an argument or explanation is determined by the relationship between its premises and conclusion, and is independent of how we feel about the situation or subject matter. The logician is like a building inspector whose job is to determine whether a house has a sound structure, irrespective of whether the house is personally appealing or not. Thus, an argument may be valid though one does not wish to accept it. This is like finding a solidly constructed house that nonetheless you would not want to live in. On the other hand, an argument may appeal to one even though (upon inspection) we find that the argument is not valid. This is like finding a house that you would like to live in, only to find (upon inspection) that the house is not soundly constructed. Even if the house is structurally sound, it may be constructed of materials that are toxic.

In this chapter we have been concerned with the various means whereby one can be influenced to accept an argument or explanation without carefully inspecting the argument for its validity and soundness. By manipulating the attention of the listener, a presenter might be able to influence the listener to accept or reject an argument without checking it for soundness. Likewise, a realtor may emphasize the beautiful view from the living room window, but this does not mean that the house is soundly constructed.

6.C.2. Exercises: Name the fallacy involved in the following examples.

1. Why is abortion murder? Because it is the killing of an innocent human being.
2. Defense lawyer cross-examining a witness: “When did you stop beating your wife?”
3. As a candidate for governor of this state, I will treat all citizens equally and I will fight for the interests of big business.
4. Tying a game is like kissing your mother. It is not much of a victory.
5. If only Jack Pardee, the Washington Redskins football coach, had not been so conservative with his offense, the team could have won more games and Pardee would not have been fired.
6. If you go to college and earn a B.A. degree, then you will surely get a better paying job and be able to support your family better.
7. Back in my day, we rode bicycles to school. Kids today should ride bicycles, not buses to school.
8. This action is ethical. It is ethical because it is morally right. And we know it is morally right because it is not unethical.

Outline of Natural Deduction: Propositional and Predicate Calculus

Propositional Calculus

The aim of logic is to alert us to fallacious forms of reasoning that can lead to incorrect conclusions. We have shown how to test whether an argument is valid using truth tables. But when the argument is made up of many individual propositions, we may not be able to use truth tables because of the number of computations required. Truth tables are not how we ordinarily evaluate an argument's validity.

(Illustrate)

A more natural way of determining validity is to identify the conclusion and then show how it can be derived from the premises provided, using only accepted valid inference rules. The valid rules of inference make it possible to construct and assess arguments by natural deduction. If each step in deriving the conclusion from the premises is justified, then we will have proven that the conclusion in question is a valid consequence of the premises being used. Thus, if the premises are true, then its conclusion must be true.

A proof of C is constructed by identifying: the conclusion (C); the premises (P_n) that C is supposed to be inferred from; and the inference rules (R_n) used to derive C from P_n . Beginning with the premises, we infer each subsequent proposition by applying a specific valid inference rule to specific prior lines in the proof. As long as each step in the derivation of C from P_n is justified by a recognized rule of inference, the conclusion C is justified.¹

¹ Parenthetically, these are the basic assumptions of a deterministic universe. For if we could identify all the true facts about reality, and all the valid rules of inference, we could then we construct all possible truths about reality, past and future.

As we saw in classical logic, immediate inferences require only one premise. Thus, if ‘no rats are dogs’ is true, we can infer that ‘no dogs are rats’ is true. And if ‘Some dogs are brown’ is true, we can infer immediately that ‘No dogs are brown’ is false. But if ‘all dogs are canines’ is true, we cannot infer that ‘all canines are dogs’ is true: some immediate inferences are valid and some are invalid.

Following are **valid immediate inference rules** that have been identified for the propositional calculus. The reader is encouraged to carefully assess each, in order to be convinced that the rule allows only valid inferences. First, we will consider valid inferences that have only one proposition as its premise. A conclusion, C, is derived from a premise, P1, if there is a rule of inference that justifies inferring C from P1.

Immediate Inferences using only a single proposition (p)

1. Double negation (DN)

$$p // \sim \sim p$$

Ms Flotmos will take J for a treat. // It is false that Ms F will not take J for a treat.

$$\sim \sim p // p$$

It is false that J will not clean her room. // J will clean her room.

2. Tautology (Taut)

$$p // p \vee p$$

Ms Flotmos is Jamie's mother // Ms Flotmos is Jamie's mother or Ms Flotmos is Jamie's mother

$p // p \cdot p$

Ms Flotmos is Jamie's mother // Ms Flotmos is Jamie's mother and Ms Flotmos is Jamie's mother

Immediate Inferences using two propositions (p, q)

3. Addition (Add)

$p // p \vee q$

J cleaned J's room. / J cleaned J's room or ms F cleaned J's room.

4. Simplification (Simp)

$(p \cdot q) // p$

J cleaned J's room and J cleaned F's room. // J cleaned J's room.

5. Commutation (Com)

$(p \cdot q) // (q \cdot p)$

J cleaned J's room and J cleaned F's room. // J cleaned F's room and J cleaned J's room.

$(p \vee q) // (q \vee p)$

J cleaned J's room or J cleaned F's room. // J cleaned F's room or J cleaned J's room.

6. De Morgan's Rule (DM)

$$\sim (p \cdot q) // (\sim p \vee \sim q)$$

It is not the case that J cleaned J's room and J cleaned F's room. // J did not clean J's room or J did not clean F's room.

$$\sim (p \vee q) // (\sim p \cdot \sim q)$$

It is not the case that J cleaned J's room or J cleaned F's room. // J did not clean J's room and J did not clean F's room.

7. Transposition (Trans)

$$(p \supset q) // (\sim q \supset \sim p)$$

If J cleans J's room then ms F will give J a treat. // if ms F did not give J a treat then it must be because J did not clean J's room

8. Material Implication (MI)

$$(p \supset q) // (\sim p \vee q)$$

If J cleans J's room then Ms Flotmos will give J a treat. // J does not clean J's room or Ms F will give J a treat

9. Material Equivalence (ME)

$$(p \equiv q) // [(p \supset q) \cdot (q \supset p)]$$

$$(p \equiv q) // [(p \cdot q) \vee (\sim p \cdot \sim q)]$$

Immediate Inferences using three propositions (p, q, r)

10. Association (Assoc)

$$[p \vee (q \vee r)] // [(p \vee q) \vee r]$$

$$[p \cdot (q \cdot r)] // [(p \cdot q) \cdot r]$$

11. Distribution (Dist)

$$[p \cdot (q \vee r)] // [(p \cdot q) \vee (p \cdot r)]$$

I'm going home and either read or sleep. // I'm going home and I will read or I'm going home and I will sleep.

$$[p \vee (q \cdot r)] // [(p \vee q) \cdot (p \vee r)]$$

I'm going home or I will read and sleep. // I'm going home or I will read and I'm going home and I will sleep.

12. Exportation (Exp)

$$[(p \cdot q) \supset r] // [p \supset (q \supset r)]$$

$$[p \supset (q \supset r)] // [(p \cdot q) \supset r]$$

Each of the above is a valid immediate inference rule that requires only one premise to infer its conclusion. The following are **sylogistic inference rules**, and each requires the use of two premises to infer a conclusion. A conclusion, C, is derived from premises, P1 and P2, if there is a rule of inference that justifies inferring C from P1 and P2.

The following four sylogistic rules of inference are widely used in ordinary and professional discourse: Modus Ponens, Modus Tollens, Hypothetical Syllogism, and Disjunctive Syllogism.

13. Modus Ponens (MP) $p \supset q / p // q$

$p \supset q$

p _____

q

If Jamie cleans her room then Ms Flotmos will take Jamie for a treat.

Jamie cleans her room. _____

Ms Flotmos will take Jamie for a treat.

14. Modus Tollens (MT) $p \supset q / \sim q // \sim p$

$p \supset q$

$\sim q$

$\sim p$

If Jamie cleans her room then Ms Flotmos will take her for a treat.

Ms Flotmos will not take Jamie for a treat. _____

Jamie did not clean her room

If it is true that Ms Flotmos will take Jamie for a treat if Jamie cleans her room, and it is also true that Ms Flotmos will not take Jamie for a treat, then we are justified in inferring that Jamie did not clean her room.

15. Hypothetical Syllogism (HS) $p \supset q / q \supset r // p \supset r$

$p \supset q$

$q \supset r$

$p \supset r$

If Jamie cleans her room then Ms Flotmos will take J for a treat.

If Ms Fotmos takes Jamie for a treat then Jamie will be happy.

If Jamie cleans her room then Jamie will be happy.

16. Disjunctive Syllogism (DS) $p \vee q / \sim p // q$

$p \vee q$

$\sim p$

q

Jamie is three years old or four years old.

Jamie is not three years old.

Jamie is four years old.

Ms Flotmos is Jamie's mother or Ms Flotmos has deceived Jamie.

Ms Flotmos is not Jamie's mother.

Ms Flotmos has deceived Jamie.

17. Conjunction: $p / q // p \cdot q$

p

q

p · q

Ms Flotmos is Jamie's mother.

Ms Flotmos has deceived Jamie.

Ms Flotmos is Jamie's mother and Ms Flotmos has deceived Jamie.

18. Constructive Dilemma (CD)

$(p \supset q) \cdot (r \supset s) / (p \vee r) // (q \vee s)$

In syllogisms, a conclusion, C, is derived from premises, P1 and P2, if there

is a rule of inference that justifies inferring C from P1 and P2.

Suppose we are given the following syllogism.

$(p \cdot q \cdot \sim r \cdot \sim m \cdot s \cdot t) \supset (j \vee k \vee \sim m \vee \sim r \vee s \vee t)$

$(p \cdot q \cdot \sim r \cdot \sim m \cdot s \cdot t)$

$(j \vee k \vee \sim m \vee \sim r \vee s \vee t)$

This argument has 8 propositions (p,q,r,m,s,t,j,k), so a truth table would have 256 lines. But we can see that the argument has the general form of MP:

A \supset B

A

B

We can therefore conclude that it is a valid argument, without having recourse to calculations.

Now, suppose we are given the following argument:

$$\begin{array}{l} (p \cdot q \cdot \sim r \cdot \sim m \cdot s \cdot t) \supset (j \vee k \vee \sim m \vee \sim r \vee s \vee t) \\ \underline{(\sim r \cdot \sim m \cdot s \cdot t \cdot p \cdot q)} \\ (k \vee j \vee \sim m \vee \sim r \vee s \vee t) \end{array}$$

$(p \cdot q \cdot \sim r \cdot \sim m \cdot s \cdot t)$ is not identical to $(\sim r \cdot \sim m \cdot s \cdot t \cdot p \cdot q)$. But by using

the rule of association, $(p \cdot q \cdot \sim r \cdot \sim m \cdot s \cdot t)$ can be derived from

$(\sim r \cdot \sim m \cdot s \cdot t \cdot p \cdot q)$ as follows:

1	<u>$(p \cdot q \cdot \sim r \cdot \sim m \cdot s \cdot t) \supset (j \vee k \vee \sim m \vee \sim r \vee s \vee t)$</u>	P1
2	<u>$(\sim r \cdot \sim m \cdot s \cdot t \cdot p \cdot q)$</u>	P2
3	$[(\sim r \cdot \sim m \cdot s \cdot t) \cdot (p \cdot q)]$	2, Assoc
4	$[(p \cdot q) \cdot (\sim r \cdot \sim m \cdot s \cdot t)]$	3, Assoc
5	$(p \cdot q \cdot \sim r \cdot \sim m \cdot s \cdot t) //$	4, Assoc
6	$(j \vee k \vee \sim m \vee \sim r \vee s \vee t)$	1, 5 MP

Consider the following argument:

$$\begin{array}{l} (p \cdot q \cdot \sim r \cdot \sim m \cdot s \cdot t) \supset (j \vee k \vee \sim m \vee \sim r \vee s \vee t) \\ \underline{\sim(j \vee k \vee \sim m \vee \sim r \vee s \vee t)} \\ \sim(p \cdot q \cdot \sim r \cdot \sim m \cdot s \cdot t) \end{array}$$

To prove that this argument is valid using truth-tables would require a truth-table of $2^8 = 256$ lines. However, we can see that the conditional first premise and the negation of the consequent

clause of the first premise allows us to derive the negation of the antecedent clause of the first premise by the inference rule MT.

Consider the following argument:

$$(p \cdot q \cdot \sim r \cdot \sim m \cdot s \cdot t) \supset (j \vee k \vee \sim m \vee \sim r \vee s \vee t)$$

$$\underline{(j \vee k \vee \sim m \vee \sim r \vee s \vee t) \supset (p \cdot q \cdot r \cdot d \cdot e \cdot f)}$$

$$(p \cdot q \cdot \sim r \cdot \sim m \cdot s \cdot t) \supset (p \cdot q \cdot r \cdot d \cdot e \cdot f)$$

This argument would also require a truth table of 256 lines to prove its validity. Yet we are convinced that it is a valid argument because it has the HS syllogistic form. And any argument with a HS form is a valid argument.

Likewise we are convinced that the following argument is valid, not because of truth tables, but because we recognize that it has the form of a disjunctive syllogism, and any argument with a DS form is a valid argument:

$$(p \cdot q \cdot r \cdot d \cdot e \cdot f) \vee (j \vee k \vee \sim m \vee \sim r \vee s \vee t)$$

$$\underline{\sim (p \cdot q \cdot r \cdot d \cdot e \cdot f)}$$

$$(j \vee k \vee \sim m \vee \sim r \vee s \vee t)$$

Examples: (need example using HS)

1	$p \supset (q \supset r)$		
2	$r \vee p$		
3	$\sim r$	//	$q \supset r$
4	p		2, 3 DS
5	$q \supset r$	1, 4 MP	

1	$\sim(p \supset q) \supset (\sim r \supset s)$		
2	$(p \supset q) \supset r$		
3	$\sim r$	//	s
4	$\sim(p \supset q)$	2, 3 MT	
5	$\sim r \supset s$	1, 4 MP	
6	s	5, 3 MP	

1	p		
2	$p \supset \sim q$		
3	$\sim q \supset \sim t$		
4	$t \vee s$	//	s
5	$\sim q$	2, 1MP	
6	$\sim t$	3, 5 MP	
7	s	4, 6 DS	

When we make an inference, only certain information out of all the information available to us is relevant. From the possible premises given below, select those that can be used to infer certain of the possible conclusions:

Possible Premises:

1. $p \supset (q \supset r)$
2. $r \vee p$
3. $s \vee \sim p$
4. $(q \supset r) \supset (p \supset q)$
5. $\sim(p \supset q) \supset \sim(r \supset s)$
6. $(p \supset q) \supset r$
7. $\sim p \supset (q \supset \sim r)$
8. $\sim s \supset (\sim r \supset p)$
9. $\sim s$
10. $\sim r$

Possible Conclusions:

- C1 p
- C2 $\sim p$
- C3 q
- C4 $\sim q$
- C5 r
- C6 $\sim r \supset p$
- C7 s
- C8 $\sim r \supset p$

C9 $q \supset r$

C10 $q \supset \sim r$

C11 $r \supset q$

12 $\sim r \supset q$

13 $s \vee p$

14 $s \vee \sim p$

15 $\sim s \supset p$

Suppose we are given the following premises:

P1: $(P \supset Q) \cdot (Q \supset \sim P)$

P2: $P \vee Q$

P3: $\sim Q$

P4: $(D \supset Q) \cdot (R \supset D)$

P5: $(Q \supset D) \cdot (E \supset R)$

P6: $Q \vee E$

P7: $\sim P \supset Q$

P8: $R \supset \sim D$

P9: $\sim P \vee R$

P10:

Which of the above ten propositions can be used to derive which of the following conclusions:

C1: $E \supset F$

C2: $D \vee Q$

C3: $Q \vee \sim D$

C4: D

C5: E

C6:

C7

Universal generalization (UG): $Fa // (\forall x) Fx$ invalid

This is generally an invalid argument. For there are many cases where what is true of a need not be true of b and c. (There are exceptions to this in certain proof strategies used in natural deduction.)

Existential generalization (EG): $Fa // (\exists x) Fx$ valid

It is always valid to infer that something has the property F if we already know that a has that property.

Universal instantiation (UI): $(\forall x) Fx // Fa$

valid

If it is true that all members of U1 have property F, then if a is a member of U1 then a must have the property F.

Existential instantiation (EI): $(\exists x) Fx // Fa$ invalid

If we know that some individual in U1 has the property F, we cannot conclude that a must be that individual.

(Exercises needed)

The 18 rules of propositional logic and the additional valid rules of predicate logic make it possible to do natural deductions in both propositional and predicate logic. These formal languages make it possible to express ordinary and technical inferences in a form that can be used by modern information technology.

(Exercises needed)